

MOULDING CATALOG

NEW YORK BOOK 2022



VISIT WWW.RBSCORP.COM CALL 1-800-378-3650

CONTENTS

Architectural Accents	28	Lattices	59
Astragals & Mullion Centers	58	Mantel	65
Back Bands	15	Neck Mouldings	44
Balusters	58	Nose & Coves	53
Band / Rake Mouldings	58	Oak Hearth Border	65
Base Cap/Panel	50-51, 54	Oak Nosing	65
Bases	2-10	Oak Saddles	65
Base Shoe	2	Oval Hand Rail	61
Beaded Edge	59	Panel Mouldings	52-53
Beaded Panel & Strip Products	102-116	Parting Strip	59
Bed Mouldings	43	Picture Frame	59
Brick Moulding	17	Picture Mouldings	59
Bullnose	60, 64	Pilasters	15
Casings	13-26	Plinth Blocks	27
Chair Rails	47-49	Poles	61
Chicago Bar Rail	61	Porch Rails	61
Colonial Corner Guards	62	Primed Pine Mouldings	78
Cove Mouldings	43	PVC Mouldings	74
Coves – Beaded	43	Quarter Rounds	61
Crown Backer	31	Sanitary Caps	62
Crowns	29-44	Sanitary Corner Guards	62
Dentil Crowns	45	Sanitary Edge	59
Dentil Mouldings	45	Screen Moulding	59
Door Sills	64	Skew Backs (Chamfers)	59
Drip Caps	62	Stepping	62
Edge & Center Bead Cap	57	Stool	63-64
Edge & Center Beads	118	Stop	60
Extension Jambs	63	Wainscot Caps	57
Flat Bottom Rail	61	Window Sills	64
Floor Mouldings	2		
Glass Beads	59		
Half Rounds	61		
Hand Rail	61		
Inside Corner	42		
Landing Treads	65		

MOULDING PROFILES



14D14.....73	8065.....61	BBSM010618.....77	ES14.....15	LWM973.....58	S9.....43	WM290.....62
14D55.....69	8066.....61	BBSM120418.....77	ES15.....52	LWP709.....2	S12.....63	WM315.....17
14D82.....71	8068.....61	BBSM120618.....77	ES16.....15	M8753.....58	S16.....63	WM327.....17
14D94.....71	8070.....61	BBTMOULD.....76	F8.....61	MCAP1.....54	S18.....63	WM351.....16
14D95.....71	8071.....61	BC5.....33	F233.....61	MCAP2.....54	S20.....63	WM356.....16
14D101.....73	8072.....61	BC78.....50	F693.....2	MCAP34.....54	S21.....63	WM361.....16
14D121.....68	8073.....61	BDB25.....11	F1021.....64	MCAP54.....54	S30.....63	WM376.....16
14D123.....68	8076.....61	BDB35.....11	F8282.....59	MCB5.....4	S31.....63	WM390.....48
14D124.....69	8077.....61	BDB45.....11	F8911.....61	MCB7.....7	S86.....43	WM412.....14
14D131.....68	8080.....61	BDB55.....11	F8912.....61	MCB512.....12	SAD4.....65	WM442.....18
14D133.....68	8121.....60	BDBCAP.....50	F8913.....61	MCB525.....5	SAD5.....65	WM444.....16
14D134.....69	8144.....60	BNS18.....64	FR214.....15	MCB712.....12	SAD6.....65	WM445.....16
14D142.....68	8186.....48	BS134.....52	FR314.....15	MCB725.....8	SAD431.....65	WM452.....14
14D145.....69	8187.....48	C103.....17	FS225.....64	MCBB1.....15	SAD531.....65	WM472.....14
14D152.....72	8200.....62	C105.....17	FS312.....64	MCBB2.....15	SAD631.....65	WM618.....4
14D153.....72	8201.....62	C106.....17	G8090.....60	MCC212.....12	SAN414.....14	WM620.....3
14D154.....72	8202.....62	C8090.....60	G8282.....59	MCC312.....12	SAN525.....14	WM624.....3
14D155.....72	8268.....63	C8121.....60	GS119.....18	MCC334.....19	SAN725.....14	WM662.....3
14D161.....73	8279.....59	C8712.....3	GS400.....20	MCC375.....19	SBC514.....33	WM714.....2
14D163.....70	8280.....59	C8753.....16	GS419.....22	MCC412.....12	SC134.....44	WM750.....11
14D164.....71	8281.....59	CB34.....42	GS425.....21	MCC434.....23	SC214.....44	WM753.....11
14D164N.....71	8282.....59	CB312.....31	GS434.....24	MCC475.....23	SC234.....44	WM875.....60
14D165.....71	8288.....59	CGM31.....17	GS441.....21	MCC534.....25	SHI.....2	WM876.....60
14D171.....73	8313.....15	CHIBAR.....61	GS694.....19	MCC575.....25	SILLCT.....64	WM887.....60
14D174.....70	8409.....51	COV7.....38	GSB412.....4	MCOV5.....32	SILLNY.....64	WM888.....60
14D175.....70	8412.....51	COV312.....31	GSB512.....6	MCOV6.....34	SPBC4.....118	WM935.....60
14D181.....73	8416.....51	COV412.....31	GSB534.....6	MCOV8.....39	SPBC8.....84	WM936.....60
14D184.....71	8417.....51	CSM.....58	GSB725.....8	MCR514.....34	STBB120618.....77	WM938.....60
14D185.....70	8422.....2	CTSHOE.....2	GSC412.....32	MCR550.....35	STFI.....16	WM1021.....64
14D191.....72	8423.....2	D1.....59	GSC512.....35	MCR650.....37	TGTBSM010618.....77	WM1300.....58
14D192.....72	8427.....2	D2.....59	GSC614.....36	MCR714.....39	TW2.....63	WM1305.....58
14D193.....72	8432.....59	D3.....59	GSC738.....40	MCR750.....41	TW4.....63	WOBB001.....79
14D194.....72	8462.....58	D4.....59	HB158.....65	MC51.....2, 54	TWEJ.....63	WOBB002.....82
14D195.....72	8463.....58	D5.....59	JC412.....22	MSC175.....44	UC31.....31	WOBC6.....84, 118
14D201.....70	8469.....58	D10.....17	L239.....58	MSC225.....44	UC41.....33	WOBM001.....79
14D202.....72	8470.....58	D693.....2	L265.....59	MSC275.....44	UC51.....35	WOBM002.....82
14D203.....72	8535.....44	D8090.....60	L623.....3	N138.....65	UC71.....38	WOBM003.....81
14D204.....72	8565.....59	D8121.....60	L634.....3	N8753.....16	VER45.....74	WOBM004.....81
14D205.....72	8575.....53	DC400.....20	L723.....2	NB514.....5	VER47.....74	WOBS001.....80
14D221.....70	8576.....53	DC412.....22	L724.....2	NY102.....59	VER49.....74	WOCH001.....79
14D222.....73	8577.....53	DC450.....23	L953.....60	NY109.....58	VER52.....74	WOCM001.....79
14D223.....73	8578.....53	DC499.....24	L995.....59	NY127.....44	VER75.....75	WOCM002.....79
14D231.....73	8590.....59	DC512.....26	L1021.....64	NY128.....44	VER93.....75	WOCM003.....79
14D232.....73	8610.....59	DC550.....26	L1084.....63	NY212.....58	VER97.....76	WOCM004.....82
14D233.....69	8611.....59	DCAS5.....25, 49	L8009.....30	OS12.....62	VER105.....76	WOCM005.....80
14D234.....69	8711.....16	DCB8.....9	L8010.....30	P214.....61	VER164.....76	WOCM006.....78
14D235.....69	8712.....3	DCB525.....5	L8013.....30	P329.....61	VER180.....76	WOCM007.....79
14D241.....69	8746.....16	DCB534.....6	L8065.....61	P514.....15	VER197.....75	WOCM008.....80
14D245.....69	8753.....16	DCB714.....8	L8080.....61	P714.....15	VER210.....75	WOCM009.....80
14D252.....73	8900.....58	DCB775.....9	L8200.....62	PB418.....27	VER212.....75	WOCM010.....80
14D261.....73	8901.....58	DCB825.....10	L8202.....62	PB518.....27	VER217.....75	WOCM011.....80
14D262.....68	8902.....58	DCB925.....10	L8269.....63	PB550.....27	VER236.....76	WOCM012.....82
14D263.....68	8904.....58	DCBB5.....6	L8279.....59	PL2.....52	VER281.....76	WOCM013.....83
14D264.....68	8908.....61	DCLK5.....24	L8282.....59	PL78.....50	VER282.....76	WOCM014.....83
14D271.....73	8926.....62	DCR512.....35	L8288.....59	PL118.....50	VER287.....75	WOCM015.....83
14D272.....73	8938.....63	DCR558.....36	L8422.....2	PL134.....52	VERHS02.....76	WOCV001.....82
14D274.....73	A8090.....60	DCR612.....37	L8423.....2	PL138.....50	VERRNCO1.....75	WOHC001.....80
14D282.....72	A8121.....60	DCR634.....38	L8535.....44	PL378.....20	VERRCO1.....75	WOPB001.....81
14D283.....72	A8173.....58	DCR725.....40	L8712.....3	PL458.....23	WC1.....17	WOPM004.....78
14D284.....73	A8926.....62	DCR734.....41	L8746.....16	PL514.....25	WC1CT.....17	WORS6.....84
14D293.....73	B34.....50	DCR814.....41	L8753.....16	PLANK.....44	WC2.....17	WORS8.....84
14D712.....71	B608.....50	DCWC5.....24	L8938.....63	Plantation.....84	WC78.....57	WOSP001.....84
28D154.....72	B658.....50	DTL112.....45	L8940.....64	PLB8.....9	WC214.....57	WOST001.....80
1388B.....15	B660.....50	DTL158.....45	LF8834.....61	PLB9.....10	WM47.....30	WOST004.....78
693.....2	B662.....44	DTL334.....45	LF8835.....61	PLB612.....7	WM53.....30	WOTG6.....84
1268B.....63	B672.....59	DTL512.....45	LK3.....18	PLB714.....8	WM81.....43	WOWC002.....83
1274.....63	B8090.....60	E2E432.....14	LK4.....20	PLB8416.....5	WM85.....43	WOWC003 15, 57, 83
8013.....30	B8121.....60	E693.....2	LS6.....64	PLC99.....36	WM93.....43	WOWC006.....84
8016.....43	B8173.....58	E8090.....60	LT312.....65	PLC612.....37	WM97.....17	WOWS001.....82
8017.....43	B8712.....3	ECB6.....118	LWM47.....30	PLC634.....37	WM130.....58	WOWS002.....80
8018.....43	B8712N.....3	ECBCAP.....15	LWM49.....30	PLC712.....40	WM133.....58	WP101.....43
8024.....43	B8746.....16	ES1.....18	LWM70.....43	PLC812.....42	WM163.....50	WP140.....59
8026.....43	B8753.....16	ES2.....18	LWM135.....58	PLC1012.....42	WM164.....50	WP210.....44
8027.....30	BB6.....7	ES3.....22	LWM204.....62	PLP312.....53	WM180.....17	WP211.....44
8047.....44	BB7.....7	ES4.....21	LWM264.....59	PLR334.....49	WM197.....62	WP830.....60
8052.....43	BB138.....50	ES5.....49	LWM297.....48	PM2200.....19	WM206.....62	WP831.....60
8054.....43	BB414.....3	ES6.....49	LWM321.....17	PWS612.....64	WM209.....44	WP855.....60
8057.....61	BB458.....4	ES7.....49	LWM390.....48	PWS634.....64	WM210.....44	WP856.....60
8058.....61	BB514.....4	ES8.....49	LWM410.....14	RAB297.....57	WM212.....58	WP858.....60
8060.....43	BB514N.....4	ES9.....51	LWM412.....14	RC214.....15	WM217.....58	WP925.....60
8061.....43	BB518.....5	ES10.....65	LWM432.....16	S4.....59	WM230.....61	WP995.....59
8062.....43	BB714.....7	ES11.....52	LWM445.....14	S5.....64	WM231.....61	
8063.....61	BB738.....8	ES12.....21	LWM903.....60	S7.....43	WM265.....59	
8064.....61	BBCAP12.....15, 57	ES13.....15	LWM972.....58	S8.....61	WM281.....15	

WHERE MOULDINGS GO

ALL PROFILES SHOWN BELOW ARE FROM OUR METRO COLLECTION OF TIMELESSLY MODERN MOULDINGS.



CROWN: MCOV8, MCC412, MCAP2

CHAIR RAIL: MCAP34

BASEBOARD: MCB712

CASING HEADER: MSC275, 1x8, MCAP2

PANEL MOULDING: MCAP2

SHOE MOULDING: MCS1

CASING LEG: MCC475



BASES

Shown: DCB825 Base, Beadboard - Standard Bead SB3SB

BASE SHOE

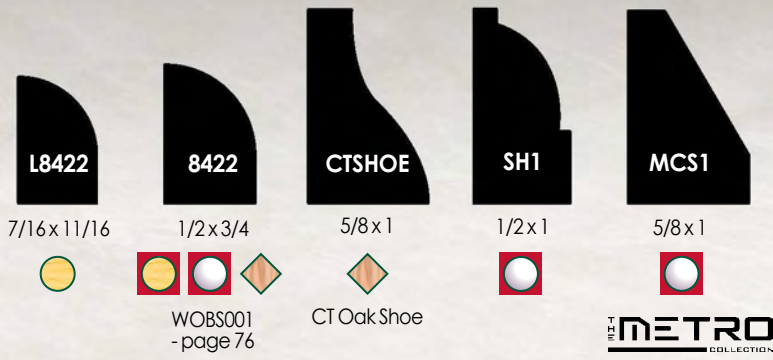

MCS1 Shoe used as cap, 1" x 6", MCS1 Shoe Moulding

FLOOR MOULDINGS



GSB534 Base with SH1 Shoe Moulding

BASES – CLAM SHELL



All profiles are available in select hardwood species on a special order basis. Actual profiles may vary slightly from what is shown.

BASES – COLONIAL

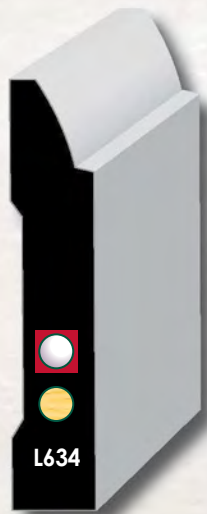

L634

7/16x2-1/4



L623

11/16x2-1/2



L8712

7/16x3

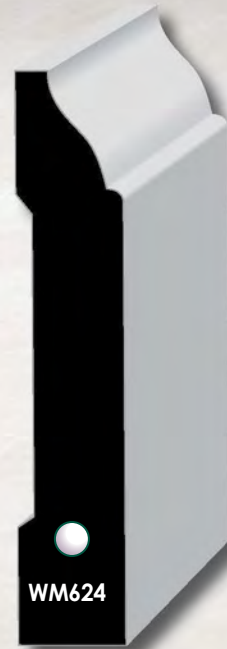

WM624

9/16x3



B8712N



9/16 x 3-1/4
(Rabbetted)



B8712

9/16 X 3-1/4
(WM623)



WM662

9/16x3-1/2
Lamb's Tongue Base



C8712

9/16x3-1/2

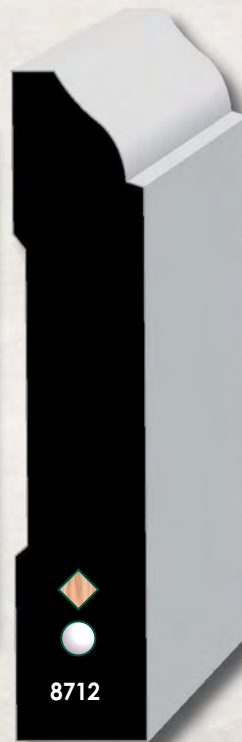

8712

11/16x3-1/2



WM620

9/16X 4-1/4



BB414

9/16 X 4-1/4



GSB412



BB458 & 8423



BB514

BASES

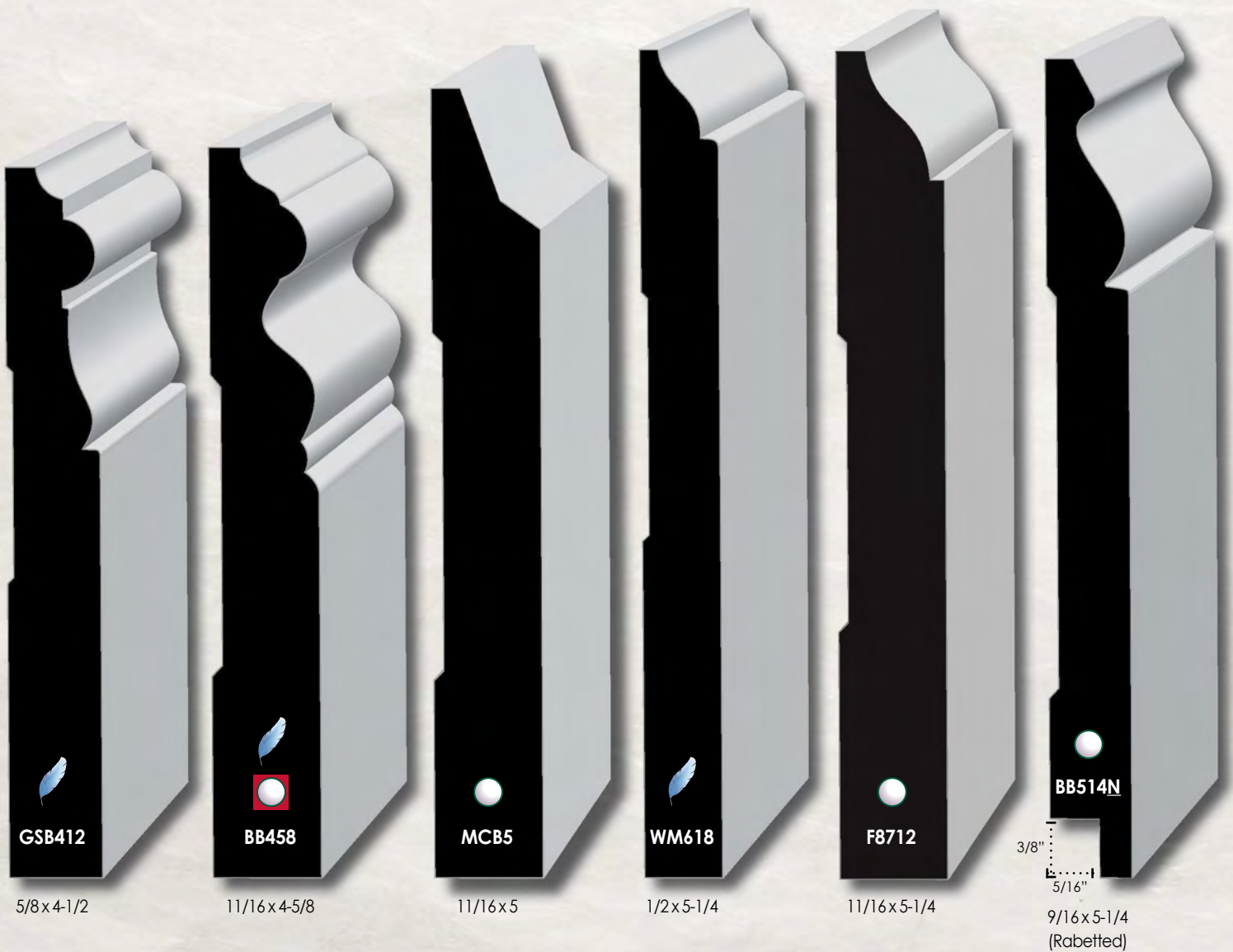

All profiles are available in select hardwood species on a special order basis. Actual profiles may vary slightly from what is shown.





GSB534

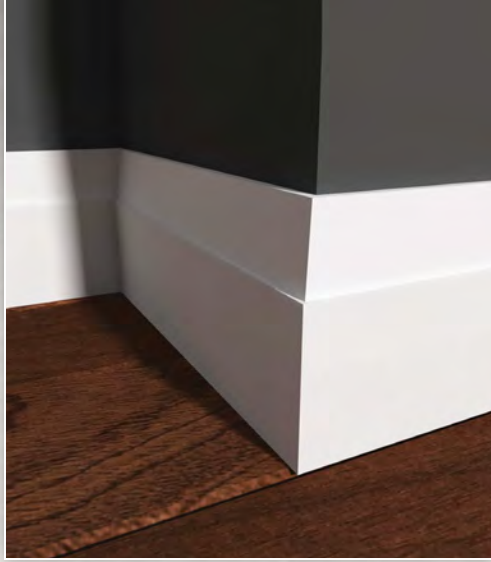

MCB525



DCB525

BASES



BB514

9/16x5-1/4



NB514

11/16x5-1/4



MCB525

9/16x5-1/4



PLB8416

5/8x5-1/4



BB518

11/16x5-1/4



DCB525

13/16x5-1/4

18' Lengths

THE METRO
COLLECTION

The
DESIGNER
COLLECTION



GSB512 & SH1



DCBB5



DCB534

BASES



GSB512
5/8 x 5-1/2



DCBB5
3/4 x 5-1/2
18' Lengths



GSB534
3/4 x 5-3/4



DCB534
13/16 x 5-3/4
18' Lengths

The
DESIGNER
COLLECTION

The
DESIGNER
COLLECTION

All profiles are available in select hardwood species on a special order basis. Actual profiles may vary slightly from what is shown.



BB6 & 8422



PLB612 & 8422



BB7 & SH1

BASES



BB6
1 1/16 x 6



PLB612
3/4 x 6-1/2



MCB7
1 1/16 x 7



BB7
1 1/16 x 7



BB714



5/8 x 7



9/16 x 7-1/4



GSB725 & SH1



MCB725 & MCS1



DCB714





GSB725
3/4 x 7-1/4



MCB725
9/16 x 7-1/4



PLB714
5/8 x 7-1/4

BB738
11/16 x 7-3/8

3/8"
5/16"



DCB714
1 x 7-1/4
18' Lengths

METRO
COLLECTION

The
DESIGNER
COLLECTION

All profiles are available in select hardwood species on a special order basis. Actual profiles may vary slightly from what is shown.



PINE



PRIMED



OAK



ULTRALITE MDF



PRIMED POPLAR



POPLAR



PVC



RED BOX = IN STOCK

BASES

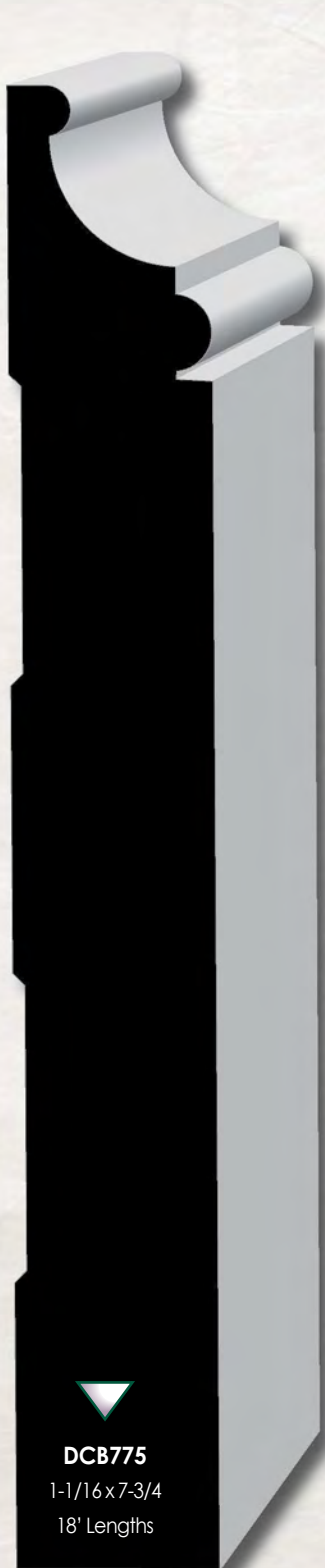

▼
DCB775
 1-1/16 x 7-3/4
 18' Lengths



▼
PLB8
 1 x 8



▼
DCB8
 1 x 8
 18' Lengths



DCB775



PLB8 & 8423

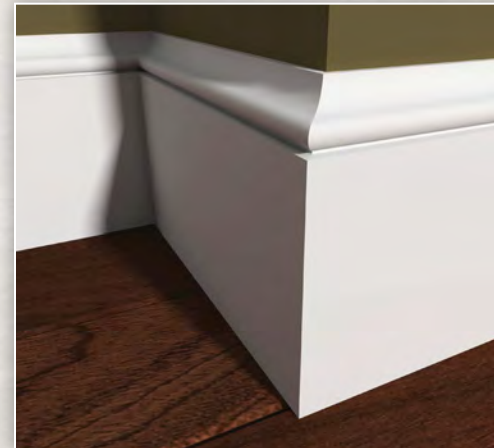

DCB8

BASES



DCB825



PLB9 & LWM903



DCB925



DCB825
1-5/16x8-1/4
18' Lengths



PLB9
3/4x9



DCB925
7/8x9-1/4
18' Lengths

The
DESIGNER
COLLECTION

The
DESIGNER
COLLECTION

All profiles are available in select hardwood species on a special order basis. Actual profiles may vary slightly from what is shown.



PINE



PRIMED



OAK



ULTRALITE MDF



PRIMED POPLAR



POPLAR



PVC



RED BOX = IN STOCK

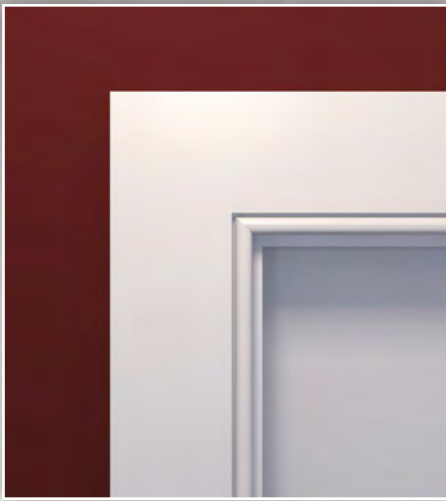

BDB35



BDB45 & ES16

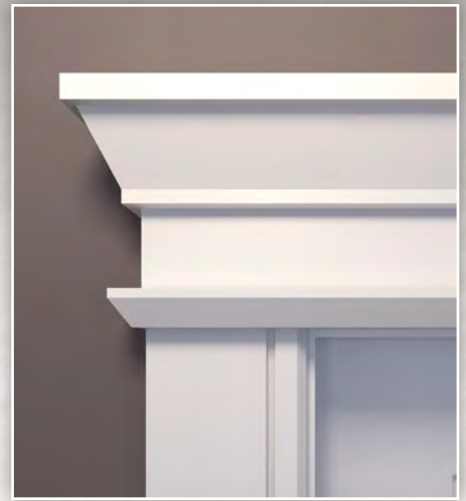

MCC412, MCS1, MSC275, 5/4" x 6"



BDB55

CASINGS/BASES –
BEADED



BDB25
3/4x2-1/2

WM753
9/16x3-1/4

BDB35
3/4x3-1/2

WM750
9/16x4-1/4

BDB45
3/4x4-1/2

BDB55
5/8x5-1/2

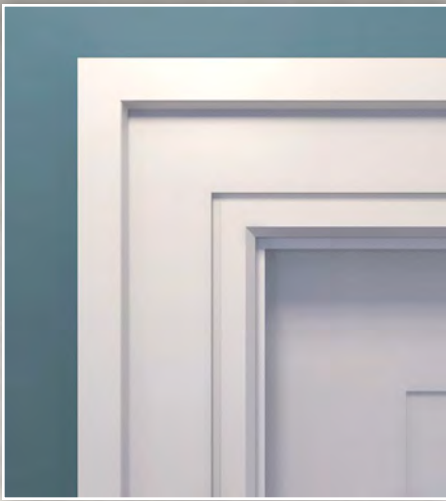

MCC312 Casing & MCBB1 Back Band

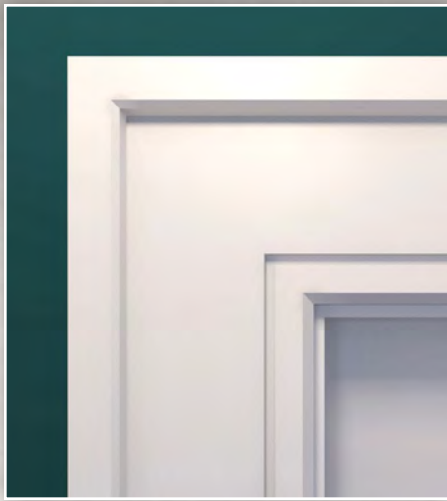

MCC412 Casing & MCBB2 Back Band



MCB512 Base, MCS1 Shoe

CASINGS/BASES – GROOVED

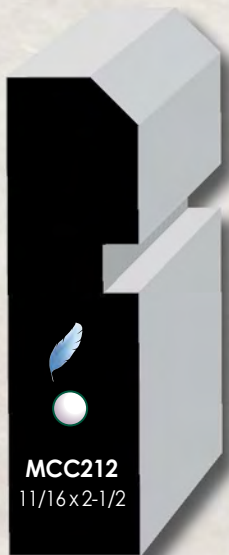

MCC212
1 1/16 x 2-1/2

THE METRO
COLLECTION

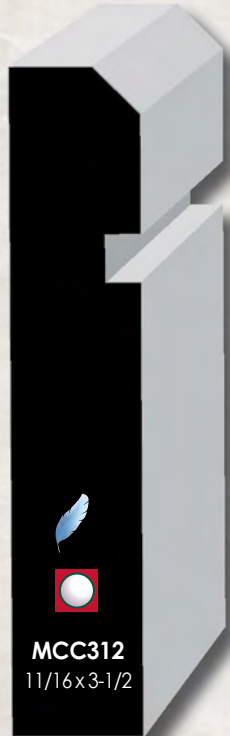

MCC312
1 1/16 x 3-1/2

THE METRO
COLLECTION



MCC412
1 1/16 x 4-1/2

THE METRO
COLLECTION



MCB512
9/16 x 5-1/2

THE METRO
COLLECTION



MCB712
9/16 x 7-1/2

THE METRO
COLLECTION

All profiles are available in select hardwood species on a special order basis. Actual profiles may vary slightly from what is shown.





CASINGS



Base, Panel & Cap: SAN525 Base, 1/4" x 1/4" Modern Groove 6" O.C., MSC175 Solid Crown, B8121
 Window: MCC312 Casing, MCB2 Back Band, LS6 Stool, MSC175 Solid Crown

CASINGS/BASES – SANITARY

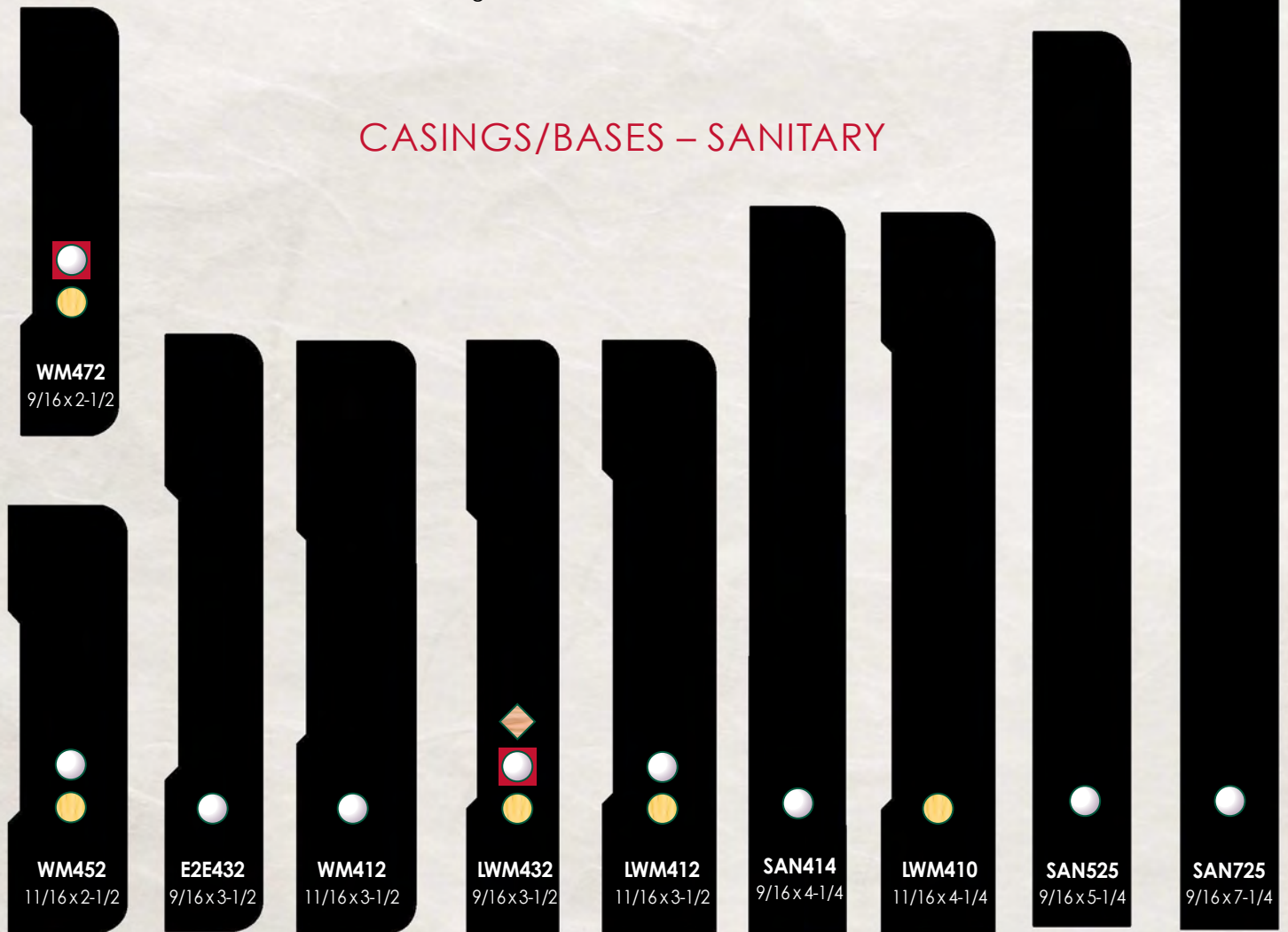

All profiles are available in select hardwood species on a special order basis. Actual profiles may vary slightly from what is shown.



BACK BANDS

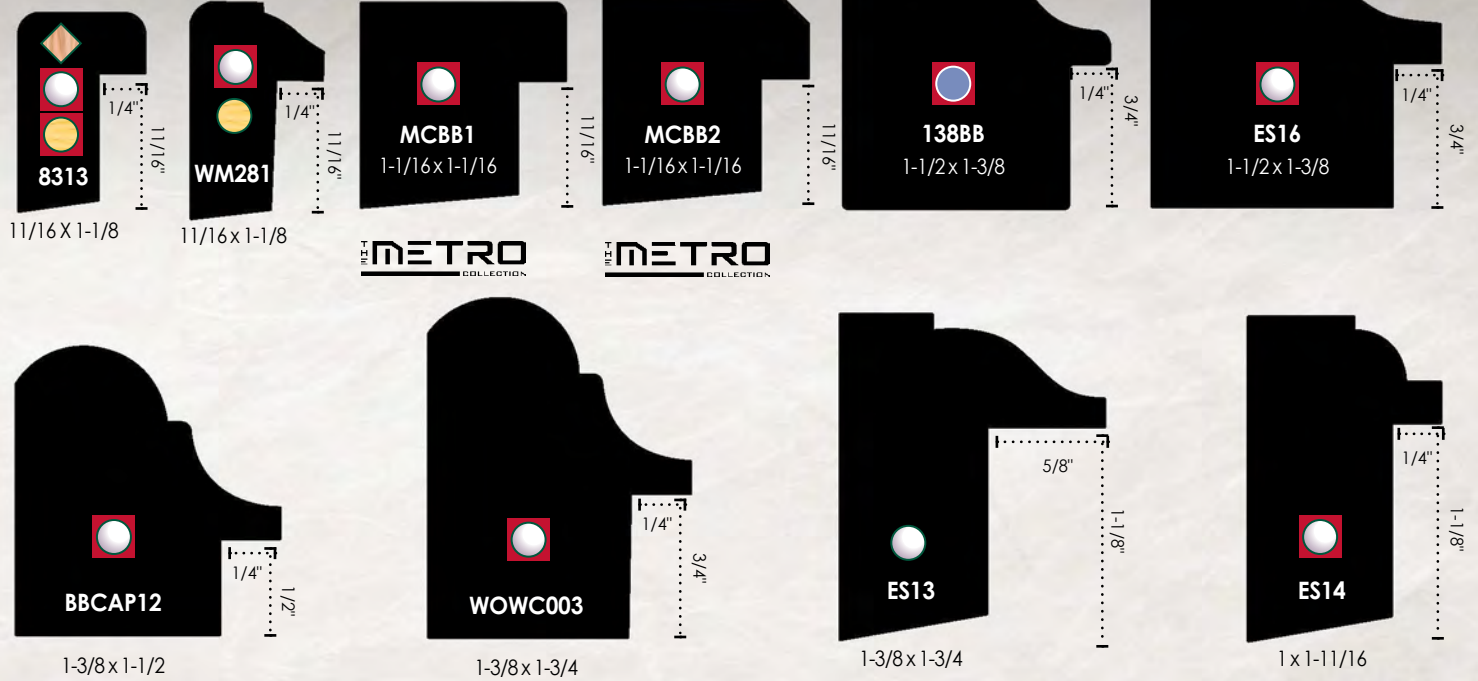

CASINGS – FLUTED/REEDED

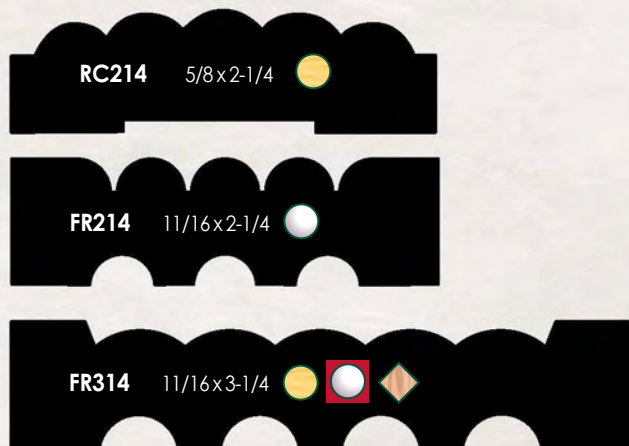

FR314 in Oak has 4 Reeds and 3 Flutes



SC234 Crown, 8577 Nose & Cove, 5/4" x 6" & FR314 Fluted/Reeded Casing

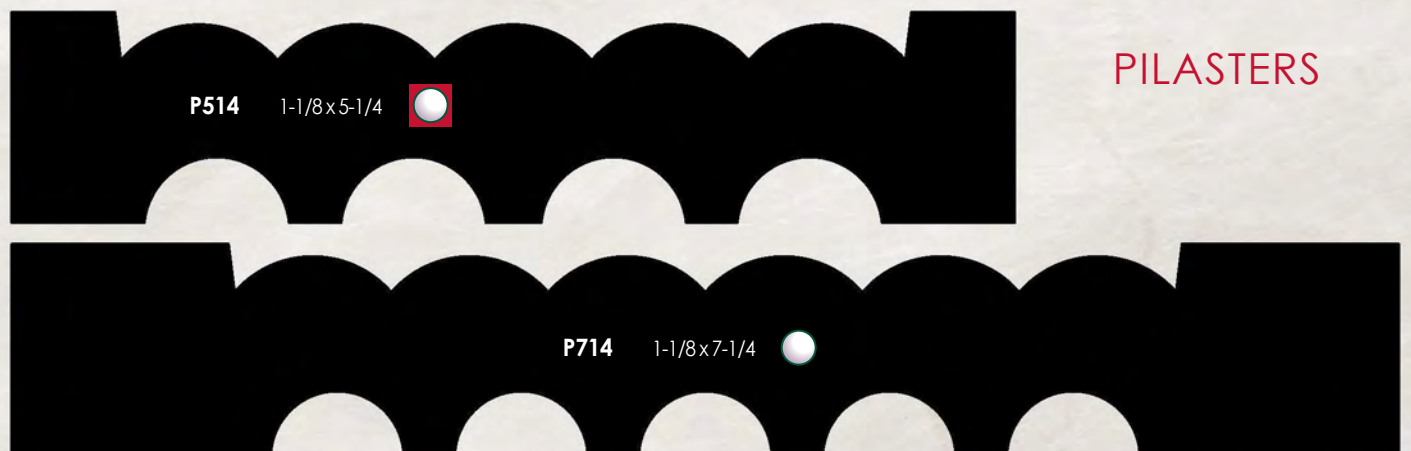

PILASTERS

CASINGS – COLONIAL



CASINGS – SPECIAL

CASINGS – COLONIAL

CASING – STAFFORD

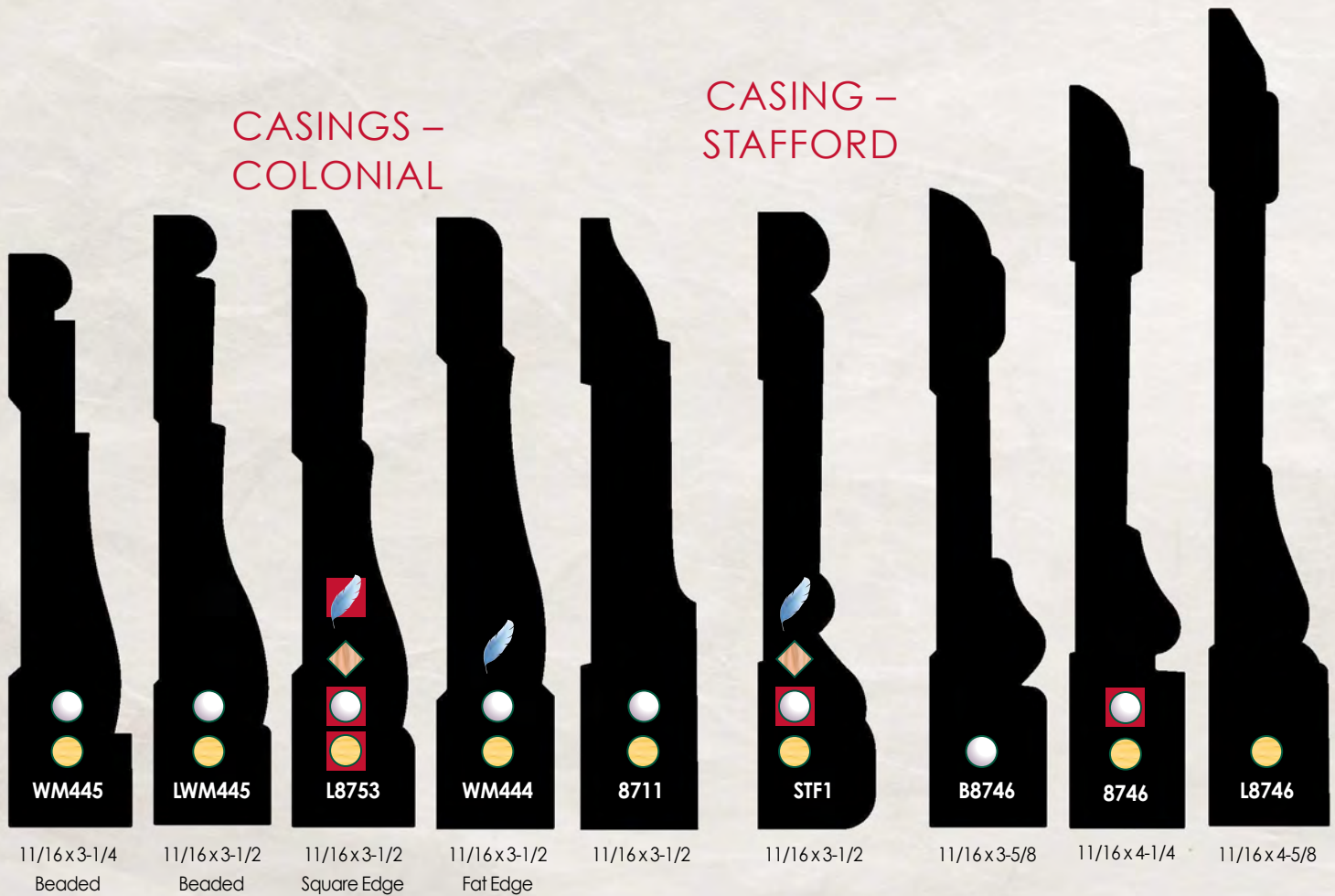

All profiles are available in select hardwood species on a special order basis. Actual profiles may vary slightly from what is shown.

CASINGS – CLAM

CASING – UNIQUE



C103
9/16x2-1/4



C105
5/8x2-1/4



C106
11/16x2-1/4



WM327
11/16x2-1/4



WM315
11/16x2-1/2



LWM321
11/16x2-1/2
Reverse Clam

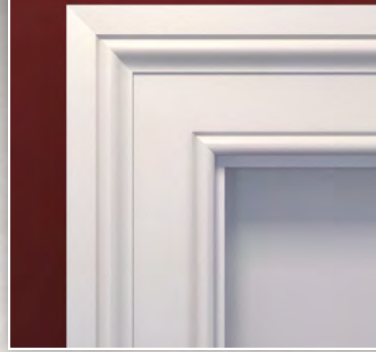

WM97

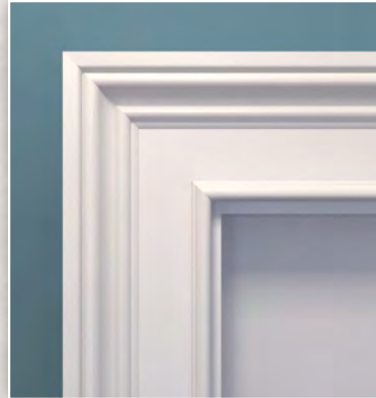

WC1

CASING – EXTERIOR

BRICK MOULDING

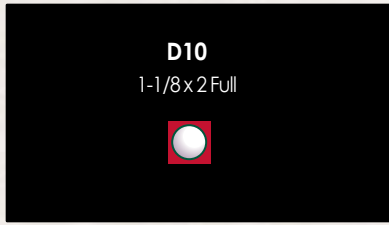

D10
1-1/8x2 Full

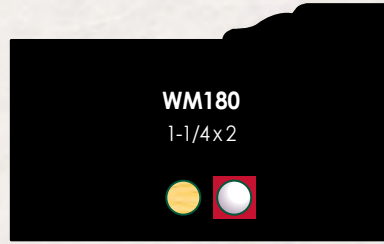

WM180
1-1/4x2



WC1CT

CASINGS – WINDSOR

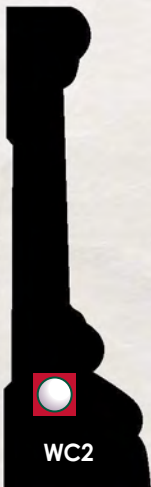

WC2
3/4x2-1/2



WM97
1-1/16x3-1/2



WC1
1-1/16x3-1/2



WC1CT
1-1/16x3-1/2



CGM31
1-1/16x3-1/2



CGM31

CASINGS



WM442



LK3



ES2



ES1

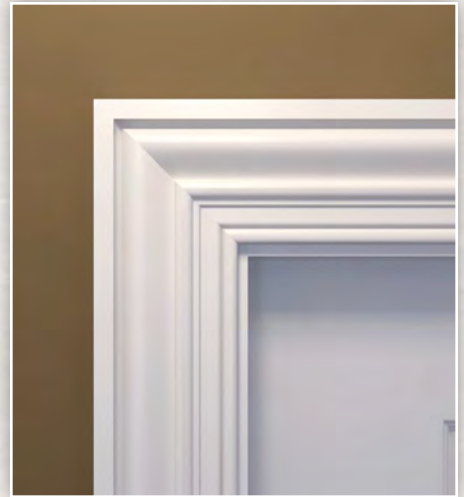

GS119

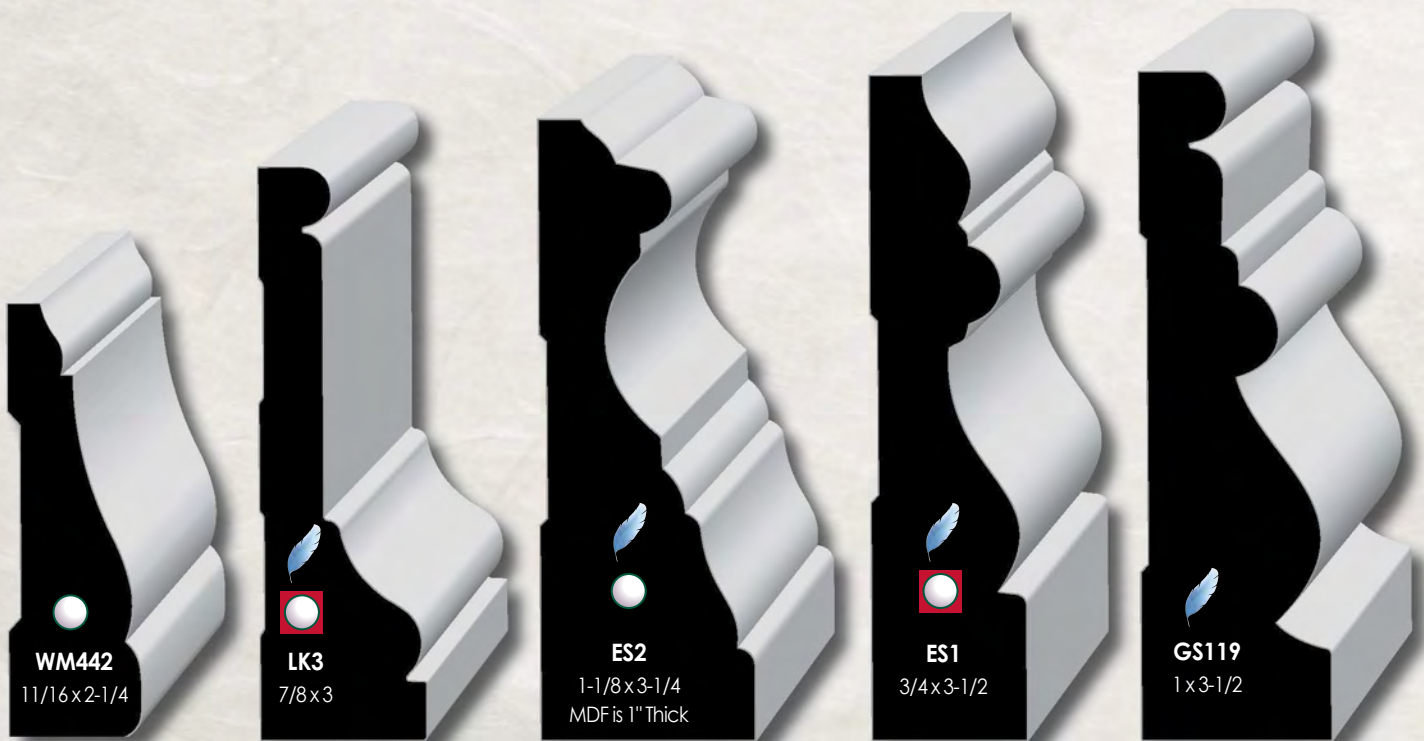

WM442
11/16 x 2-1/4

LK3
7/8 x 3

ES2
1-1/8 x 3-1/4
MDF is 1" Thick

ES1
3/4 x 3-1/2

GS119
1 x 3-1/2

All profiles are available in select hardwood species on a special order basis. Actual profiles may vary slightly from what is shown.



CASINGS



GS694

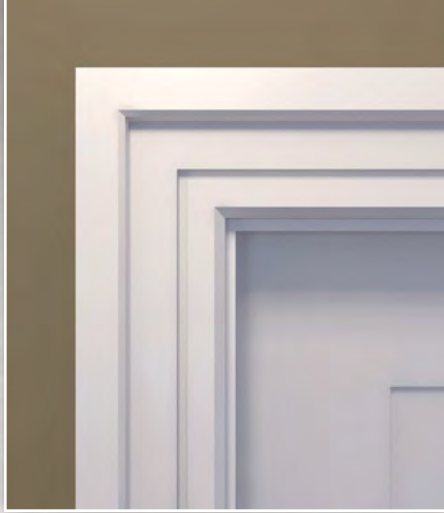

MCC212 with MCBB2



PM2200



PL378

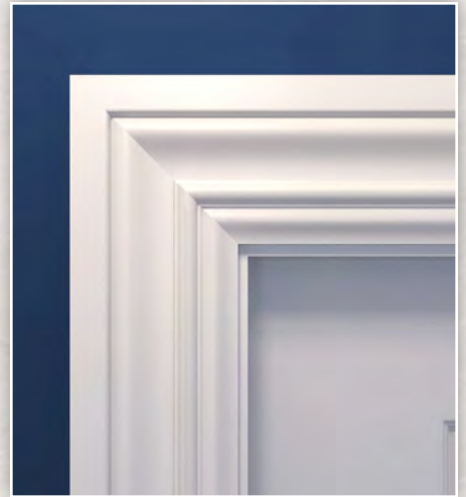

GS400



GS694
 1x3-1/2



PM2200
 1-1/8x3-3/4

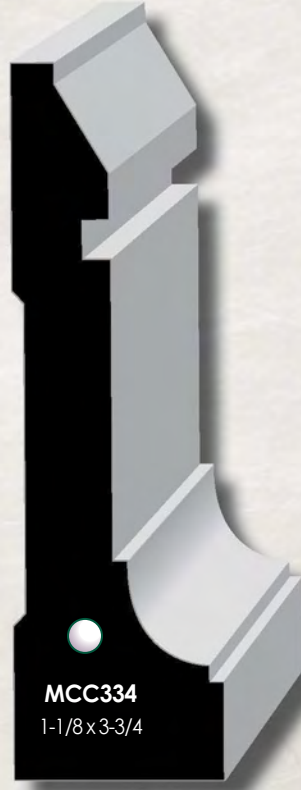

MCC334
 1-1/8x3-3/4



MCC375
 1-1/8x3-3/4

CASINGS

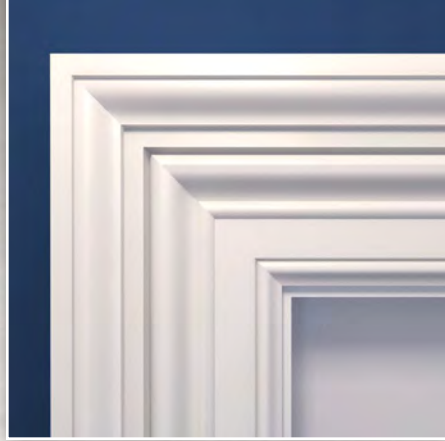

ES3 & ES13



ES4 & ES14

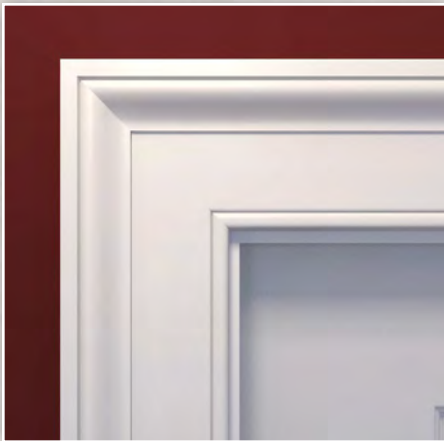

LK4



DC400



ES4



PL378
1 x 3-7/8



GS400
1 x 4



LK4
1-1/8 x 4

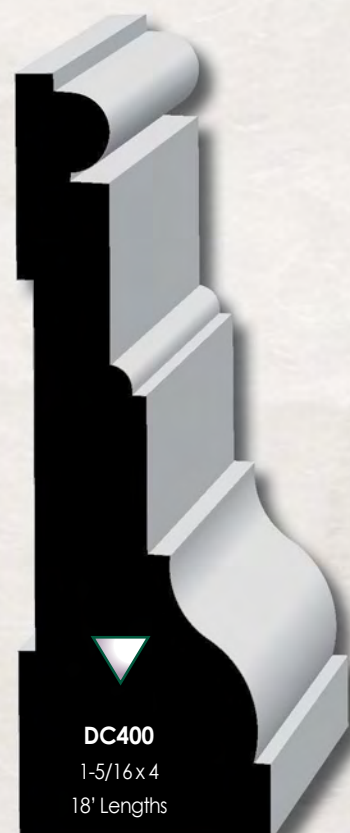

DC400
1-5/16 x 4
18' Lengths

The
DESIGNER
COLLECTION

All profiles are available in select hardwood species on a special order basis. Actual profiles may vary slightly from what is shown.



CASINGS

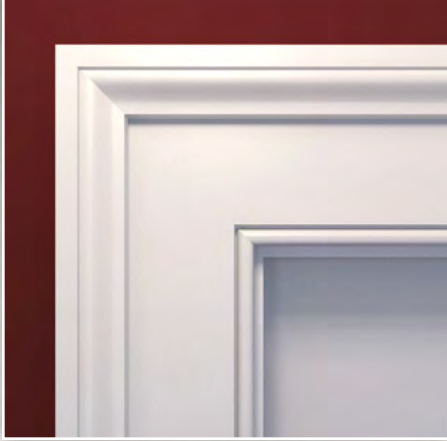

BDB35 & ES16

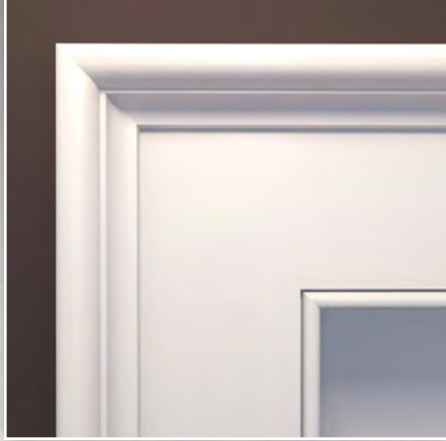

BDB45 & ECBCAP



GS425



GS441



ES12 Casing with Rosette



ES4
1x4-1/4



GS425
1-3/16x4-1/4



GS441
1-3/16x4-1/4



ES12
11/16x4-1/2

CASINGS



DC400 Casing and DCB525 Base



DC412 Casing and DCB775 Base



JC412



ES3



GS419



JC412
1-1/8 x 4-1/2



ES3
1-1/8 x 4-1/2



GS419
1-3/16 x 4-1/2

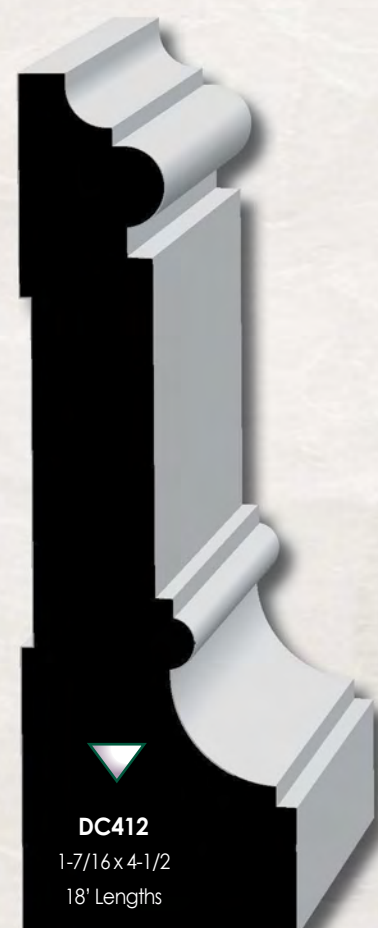

DC412
1-7/16 x 4-1/2
18' Lengths

The
DESIGNER
COLLECTION

All profiles are available in select hardwood species on a special order basis. Actual profiles may vary slightly from what is shown.



CASINGS



DC412 Casing and DCBB5 Base



DC450 Casing and DCB8 Base



DC412



DC450



PL458



DC450

1-5/8 x 4-1/2
18' Lengths



PL458

1-3/16 x 4-5/8



MCC434

1-3/8 x 4-3/4



MCC475

1-3/8 x 4-3/4

The
DESIGNER
COLLECTION

CASINGS



DCWC5 Casing and DCB534 Base



DCLK5 Casing and DCB775 Base



GS434



DCWC5



DCLK5



GS434
1 x 4-3/4

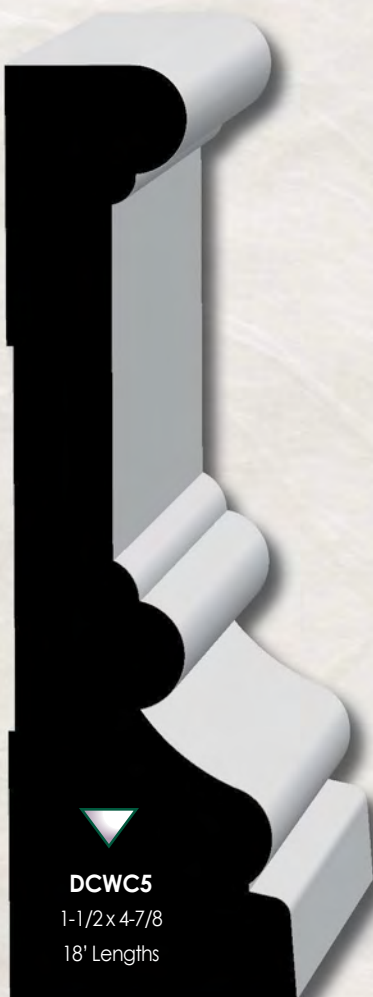

DCWC5
1-1/2 x 4-7/8
18' Lengths



DCLK5
1-1/2 x 5
18' Lengths

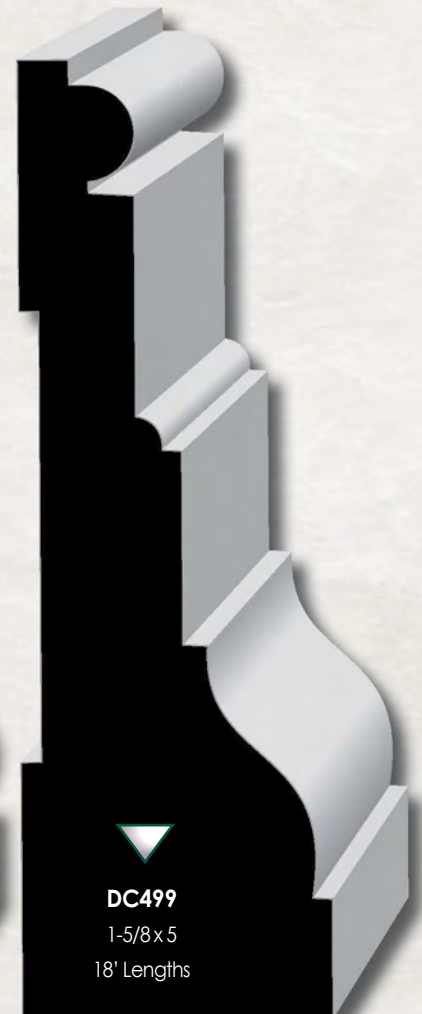

DC499
1-5/8 x 5
18' Lengths

The
DESIGNER
COLLECTION

The
DESIGNER
COLLECTION

The
DESIGNER
COLLECTION

All profiles are available in select hardwood species on a special order basis. Actual profiles may vary slightly from what is shown.



CASINGS



DC499 Casing and DCB714 Base



DCAS5 Casing and DCB8 Base



DC499



PL514



DCAS5



PL514

1-3/16 x 5-1/4



DCAS5

1-3/4 x 5-1/2

18' Lengths

* Also used as Chair Rail



MCC575

1-3/8 x 5-3/4



MCC534

1-3/8 x 5-3/4

The
DESIGNER
COLLECTION

CASINGS



DC512

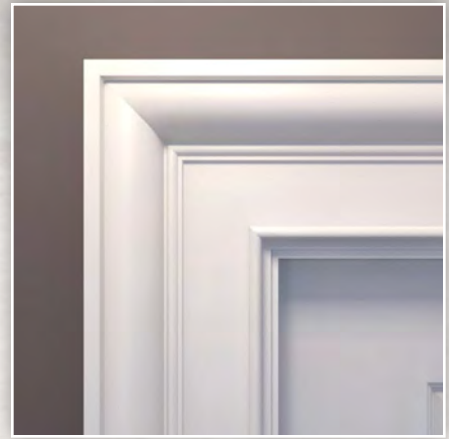

DC550



DC512 Casing and DCB925 Base



DC550 Casing and DCB825 Base

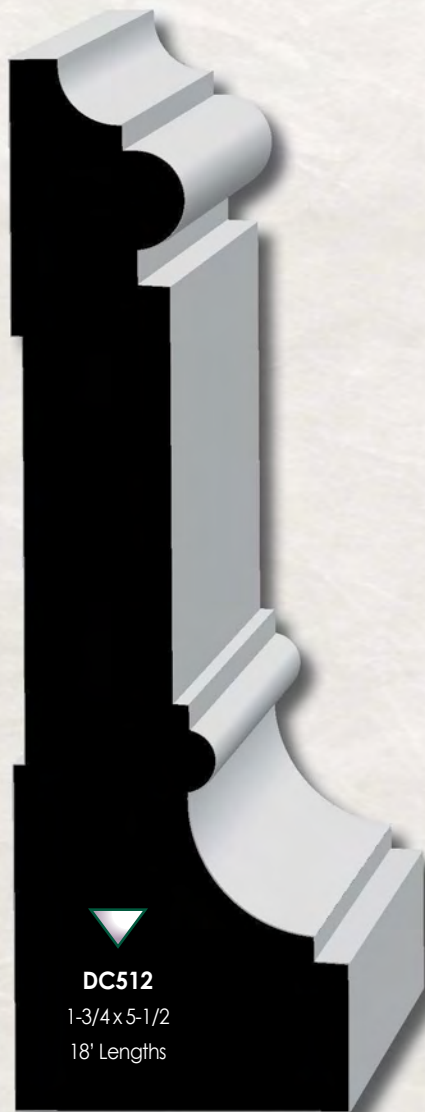

DC512
1-3/4x5-1/2
18' Lengths



DC550
2x5-1/2
18' Lengths

The
DESIGNER
COLLECTION

The
DESIGNER
COLLECTION

All profiles are available in select hardwood species on a special order basis. Actual profiles may vary slightly from what is shown.



PLINTH BLOCKS



PB550 2 x 5-1/2
Will accommodate all casings and most casing/backband combinations 4-7/8" to 5-1/4"

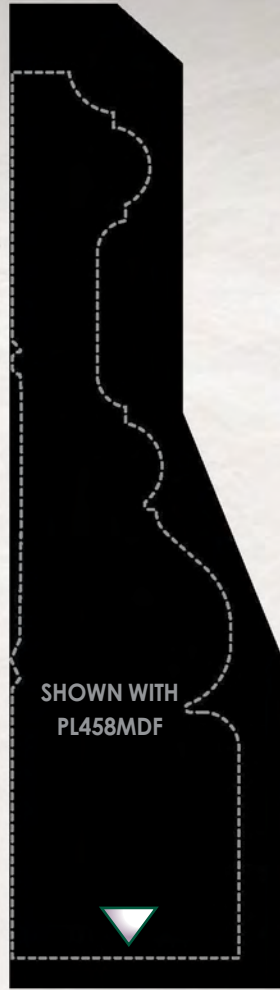

PB518 1-7/16 x 5-1/8
Will accommodate all casings and most casing/backband combinations 4" to 4-7/8" in width



PB418 1-1/4 x 4-1/8
Will accommodate all casings 3-1/4" to 3-7/8" in width



ARCHITECTURAL accents

ROSETTES

Wellington



- WEL212 (1" x 2-1/2") ●
- WEL234 (1" x 2-3/4") ●◆
- WEL312 (1" x 3-1/2") ●◆
- WEL334 (1" x 3-3/4") ●◆
- WEL412 (1" x 4-1/2") ●◆
- WEL500 (1-5/16" x 5") ▼
- WEL834 (1-1/4" x 3-3/4") ●
- WEL414 (1-1/4" x 4-1/4") ●
- WEL512 (1-1/4" x 5-1/2") ●

Cambridge



- CAM312 (1" x 3-1/2") ●◆
- CAM334 (1" x 3-3/4") ●◆
- CAM834 (1-1/4" x 3-3/4") ●
- CAM434 (1" x 4-3/4") ●
- CAM512 (1-1/4" x 5-1/2") ●
- CAM712 (1-1/4" x 7-1/2") ●

ARCH ROSETTES



- WA234 (1" x 2-3/4" x 4-1/2") ●
- WA334 (1" x 3-3/4" x 6") ●
- WA834 (1-5/16" x 3-3/4" x 7") ▼

Lexington
(daisy)



- LEX312 (7/8" x 3-1/2") ●◆
- LEX412 (7/8" x 4-1/2") ●

Pilaster



- PPB512 (1-1/8" x 5-1/2" x 8") ●
- PPB712 (1-1/8" x 7-1/2" x 8") ●

Bridgeford



- BRI234 (1" x 2-3/4" x 6") ●◆
- BRI312 (1" x 3-1/2" x 6") ●◆
- BRI334 (1" x 3-3/4" x 6") ●◆
- BRI833 (1-1/8" x 4-1/2" x 8") ●
- BRI434 (1" x 4-3/4" x 6") ●

KEYSTONES



- KEY312 (1" x 3-1/2") ●
- KEY412 (1" x 4-1/2") ●
- KEY512 (1" x 5-1/2") ●

Wellington



- WPB334 (1" x 3-3/4" x 6") ●

Rosettes and plinth blocks can be special ordered in any size, shape or species (minimum quantities apply)

All profiles are available in select hardwood species on a special order basis. Actual profiles may vary slightly from what is shown.



CROWNS

CROWNS/COVERS

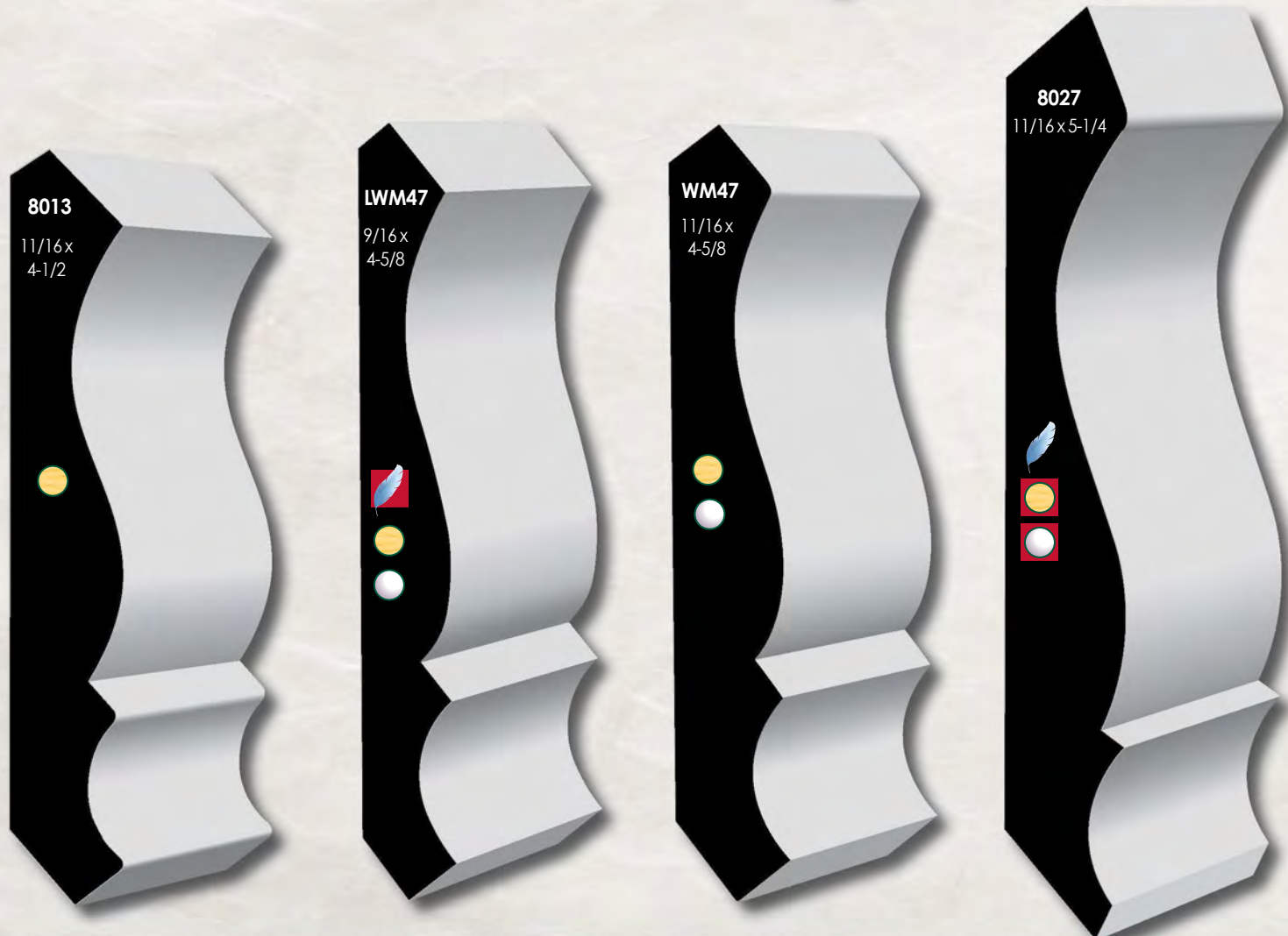
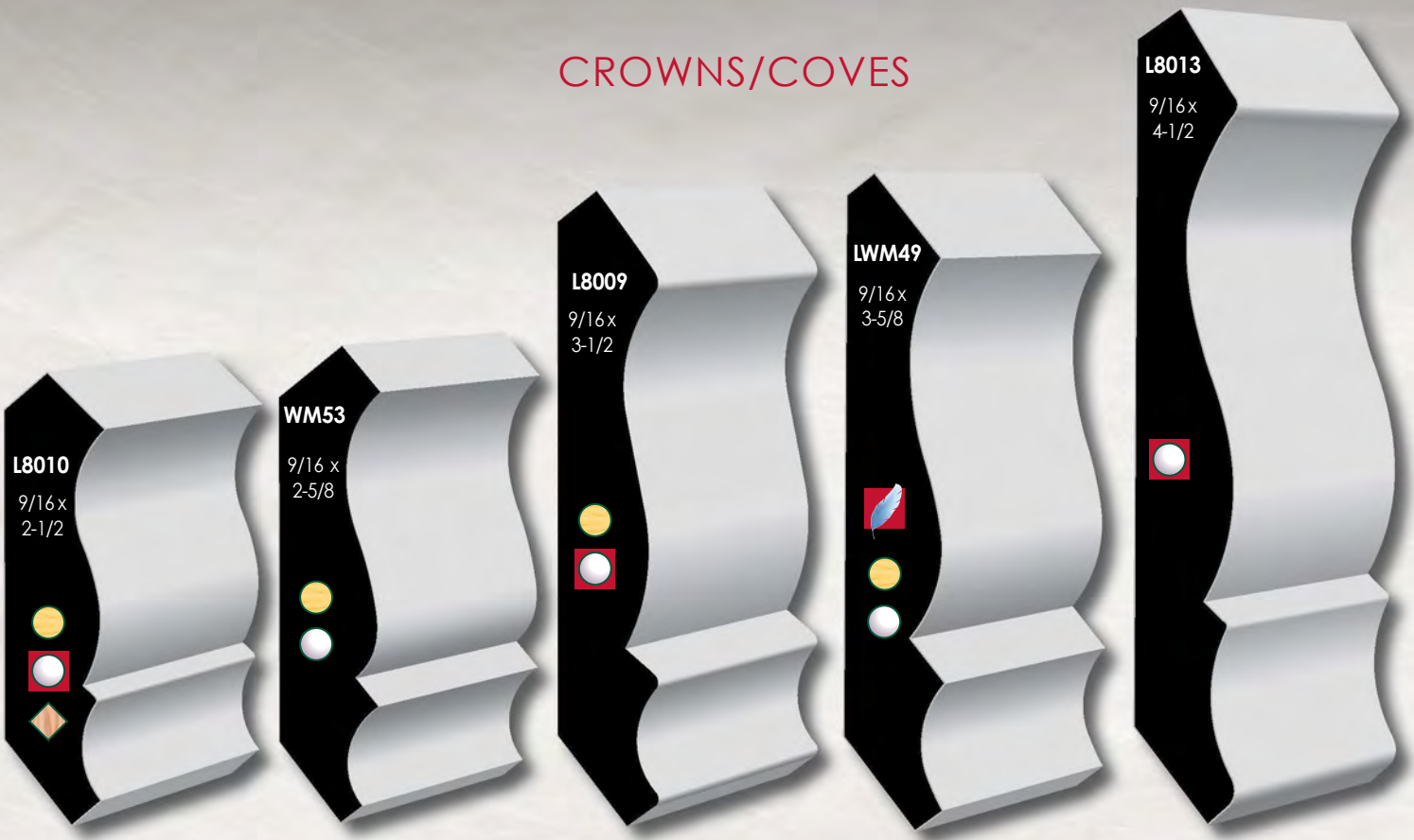

All profiles are available in select hardwood species on a special order basis. Actual profiles may vary slightly from what is shown.

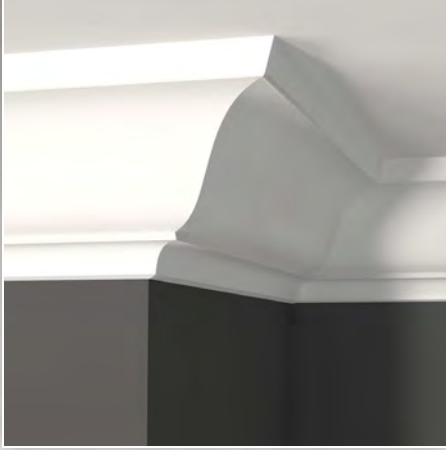

8027



CB312 and COV412



CB312 and UC51



COV312

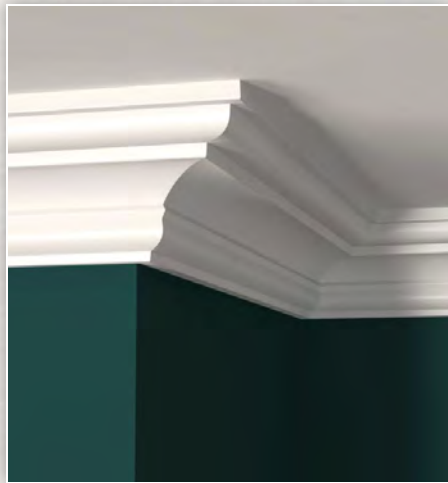

UC31

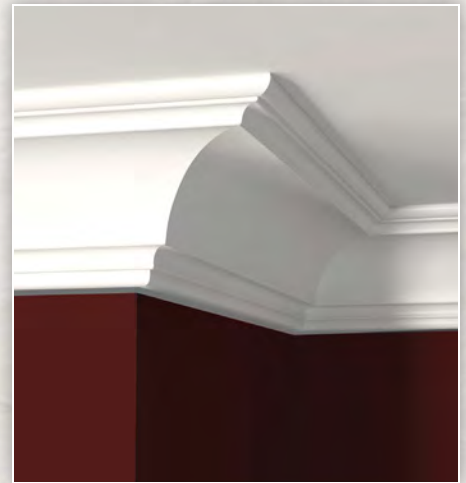

COV412

CROWN BACKER

CROWNS/COVES



CROWNS/COVES

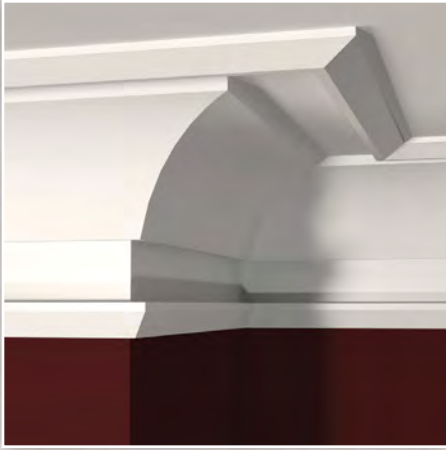

MCS1, MCOV5, MCS1

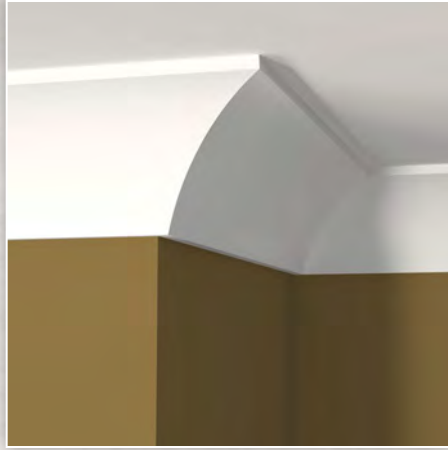

MCOV5



GSC412

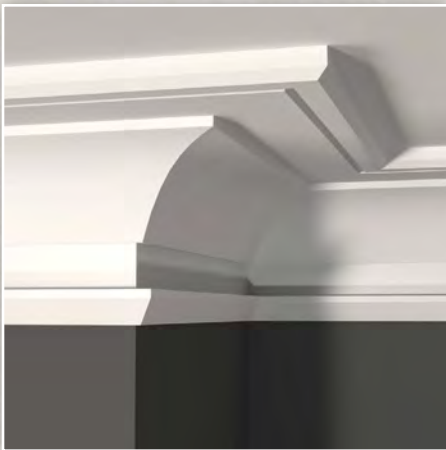
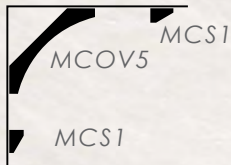

MCC412, MCOV5, MCS1

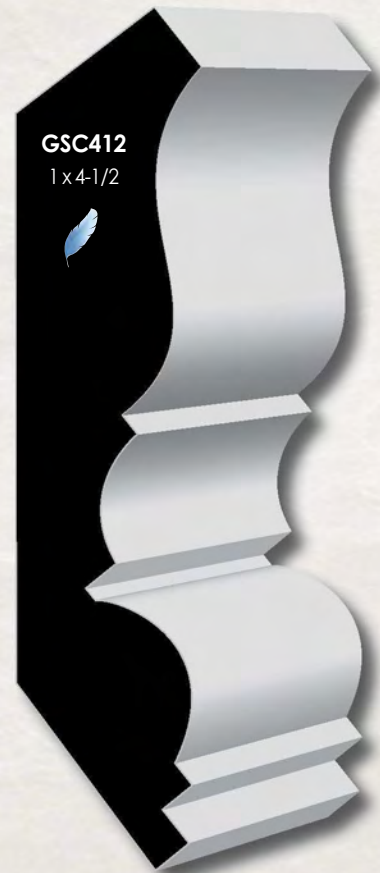
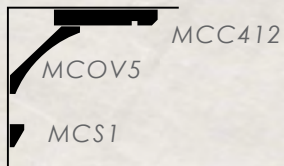

THE METRO COLLECTION

All profiles are available in select hardwood species on a special order basis. Actual profiles may vary slightly from what is shown.



CROWNS/COVES



UC41

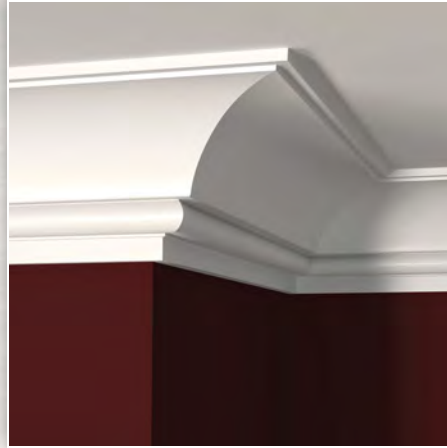

BC5



SBC514



CROWNS/COVERS

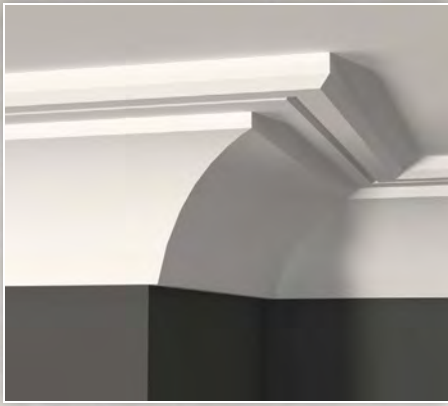

MCC312, MCOV6

Ceiling

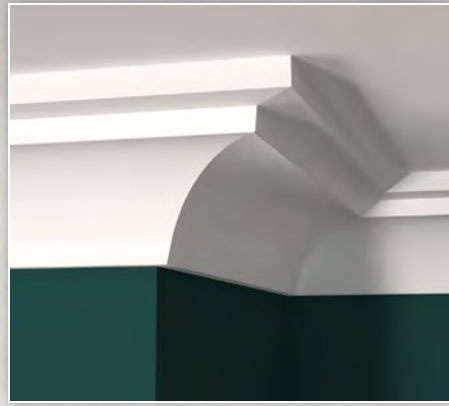

MCR514 Ceiling Step

Ceiling



Projection: 3-7/8" Height: 3-1/2"



MCR514 Wall Step

Ceiling



Projection: 3-1/2" Height: 3-7/8"



MCR514, MCC312

Ceiling

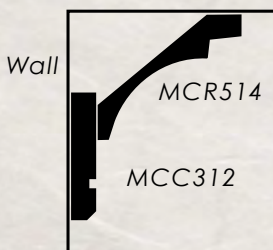

MCR514
1-1/16x5-1/4



MCOV6
1-1/8x5-1/4

METRO
COLLECTION

METRO
COLLECTION

All profiles are available in select hardwood species on a special order basis. Actual profiles may vary slightly from what is shown.



PINE



PRIMED



OAK



ULTRALITE MDF



PRIMED POPLAR



POPLAR



PVC



RED BOX = IN STOCK

CROWNS/COVES



DCR512



GSC512



UC51

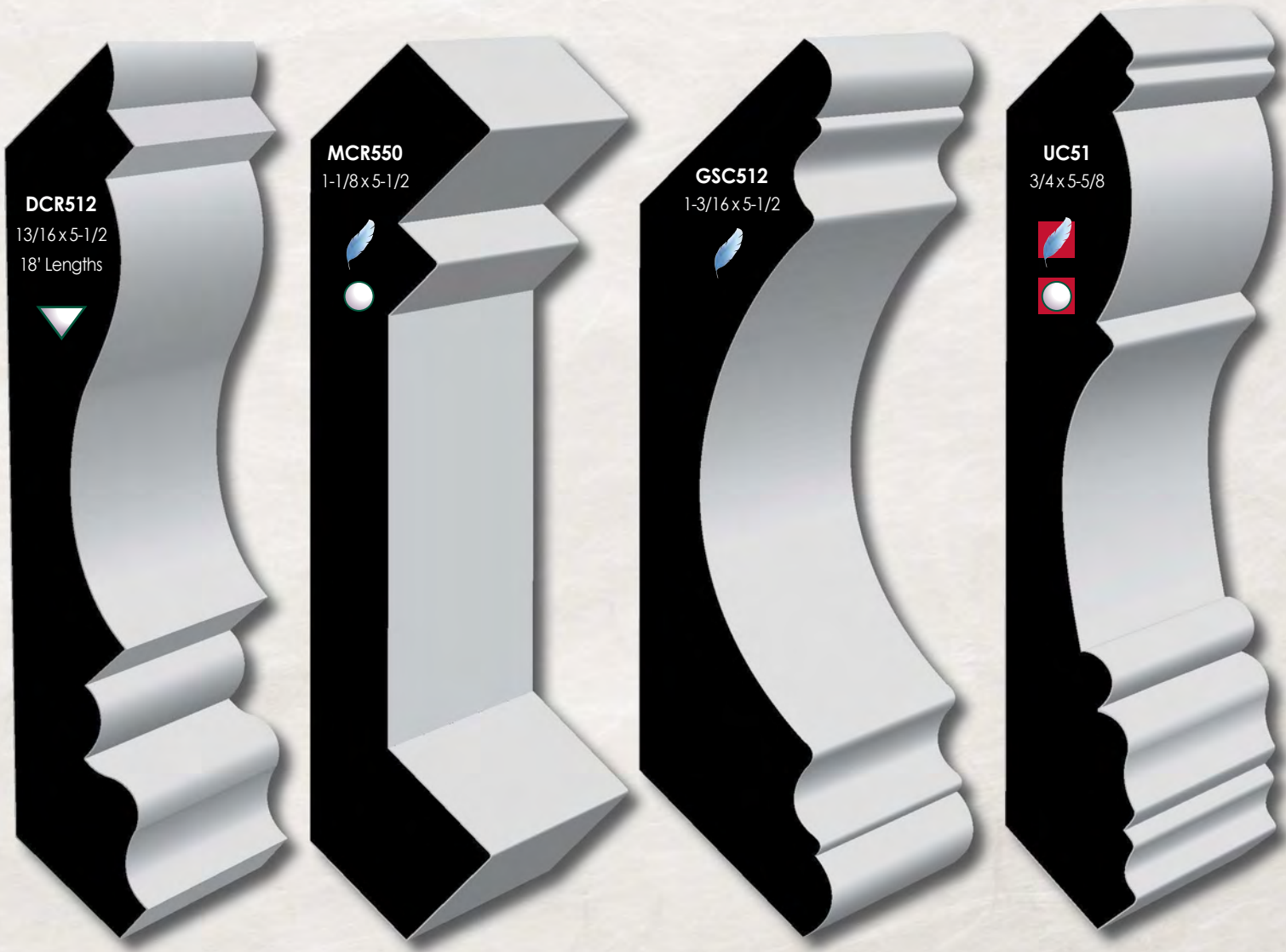

The
DESIGNER
COLLECTION

CROWNS/COVES



DCR558



PLC99



GSC614



DCR558

1-5/16 x 5-5/8

18' Lengths

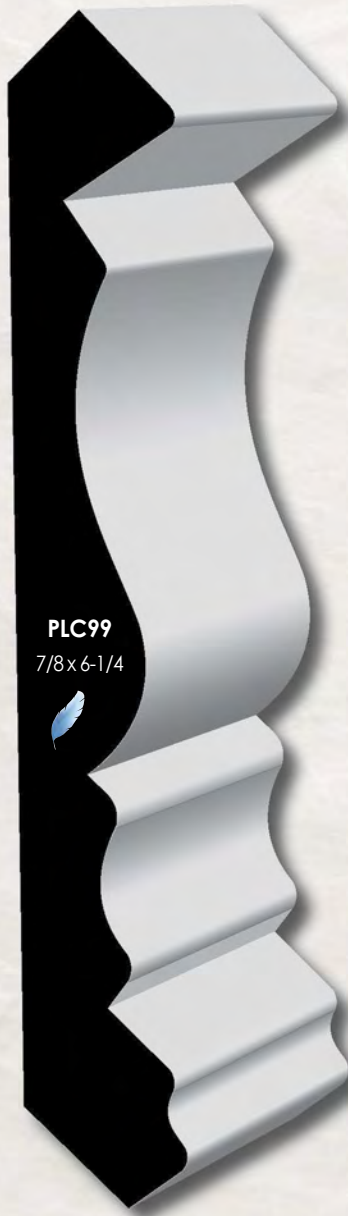

PLC99

7/8 x 6-1/4



GSC614

1-3/16 x 6-1/4



The
DESIGNER
COLLECTION

All profiles are available in select hardwood species on a special order basis. Actual profiles may vary slightly from what is shown.



PINE



PRIMED



OAK



ULTRALITE MDF



PRIMED POPLAR



POPLAR



PVC



RED BOX = IN STOCK

CROWNS/COVES



PLC612

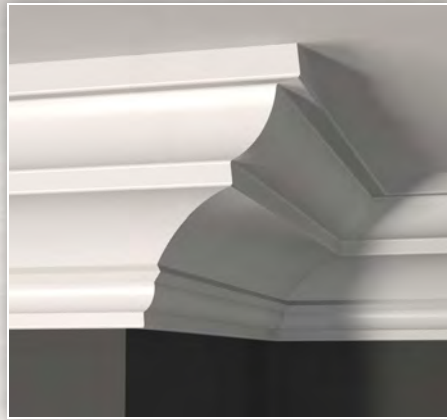

DCR612



PLC634



PLC612
3/4 x 6-1/2



DCR612
1 x 6-1/2
18' Lengths



MCR650
1-1/8 x 6-1/2



PLC634
1-3/16 x 6-3/4

The
DESIGNER
COLLECTION



DCR634



UC71



COV7

CROWNS/COVES



DCR634
1-3/4 x 6-3/4
18' Lengths



UC71
1-1/8 x 7-1/4



COV7
1-3/8 x 7-1/4



The
DESIGNER
COLLECTION

All profiles are available in select hardwood species on a special order basis. Actual profiles may vary slightly from what is shown.





MCOV8



MCR714 Ceiling Step



MCR714
1-1/16x7-1/4



MCOV8
1-1/8x7-1/4

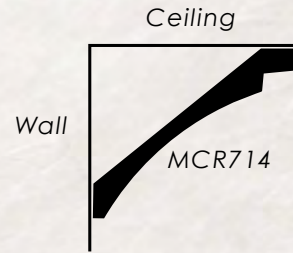

Projection: 5-1/2" Height: 4-5/8"



MCR714 Wall Step

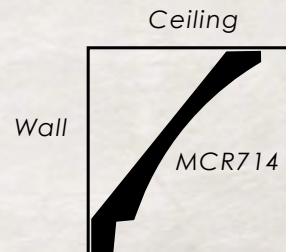

Projection: 4-5/8" Height: 5-1/2"



DCR725



GSC738



PLC712

CROWNS/COVES



DCR725
1-5/16x7-1/4
18' Lengths



GSC738
1-3/16x7-3/8



PLC712
1x7-1/2



The
DESIGNER
COLLECTION

All profiles are available in select hardwood species on a special order basis. Actual profiles may vary slightly from what is shown.





MCR750



DCR734

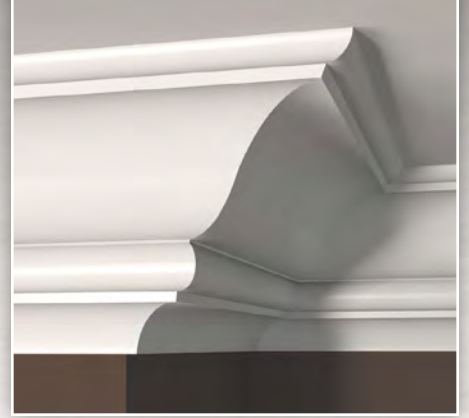

DCR814



MCR750
1-1/8 x 7-1/2



METRO
COLLECTION



DCR734
1-5/8 x 7-3/4
18' Lengths



The
DESIGNER
COLLECTION



DCR814
1-5/16 x 8-1/4
18' Lengths



The
DESIGNER
COLLECTION

CROWNS/COVES

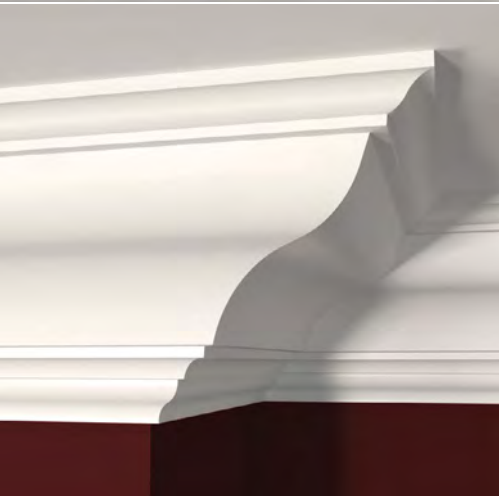

PLC1012



PLC812



PLC812
1-3/16x8-1/2



PLC1012
1-3/16x10-1/2

INSIDE CORNER

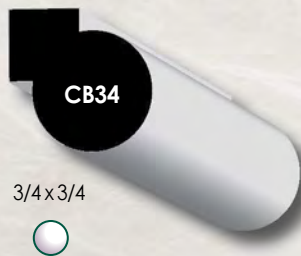

CB34

3/4x3/4



BED MOULDINGS

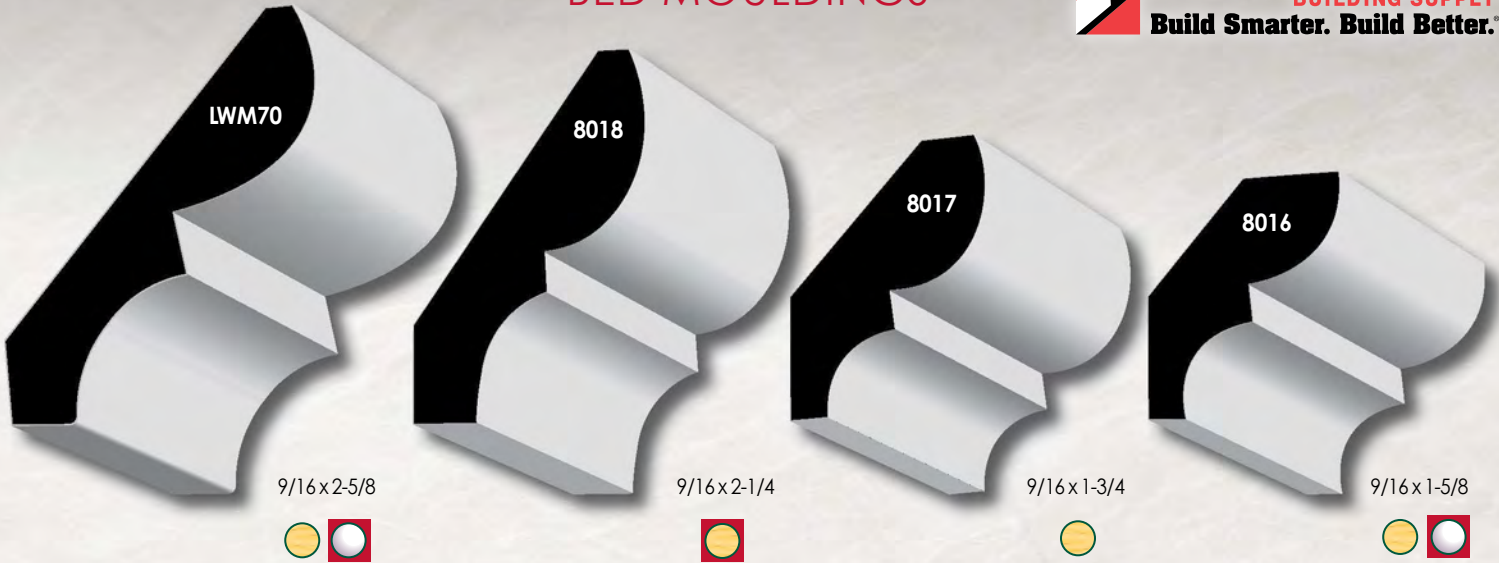

COVES – BEADED

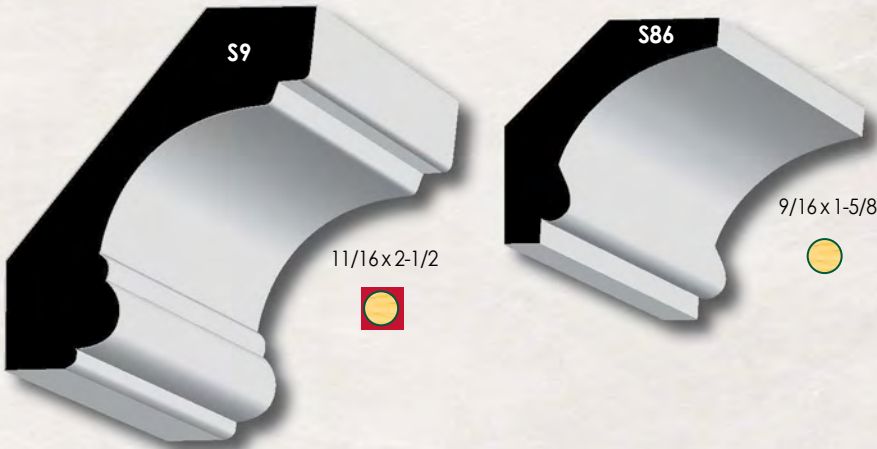

COVE MOULDINGS

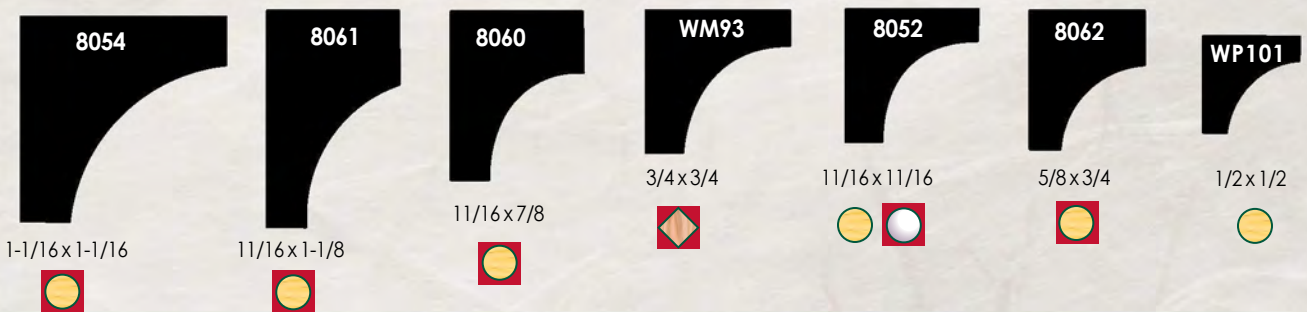
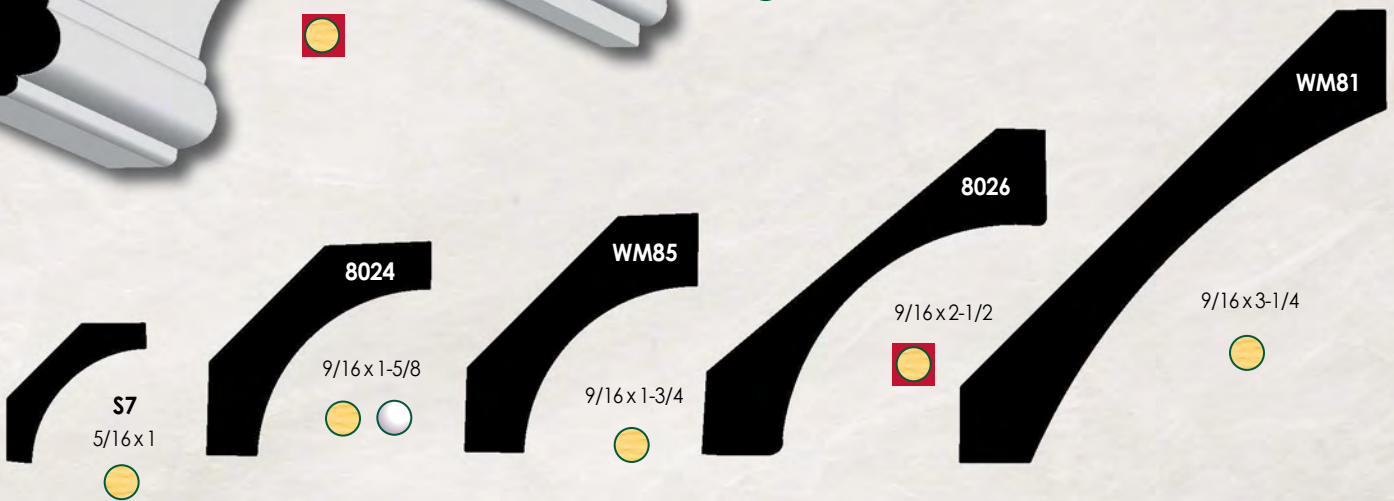

All profiles are available in select hardwood species on a special order basis. Actual profiles may vary slightly from what is shown

CROWNS – SOLID

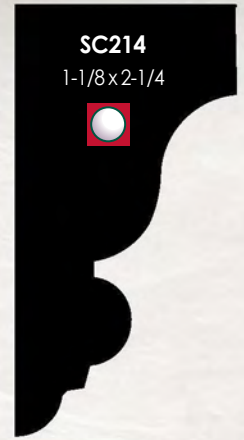
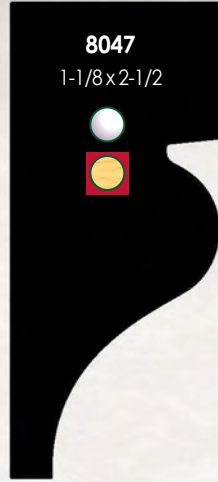
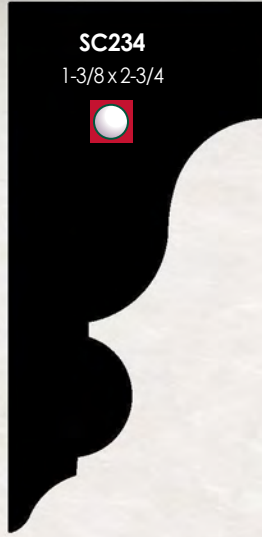

THE METRO
COLLECTION

THE METRO
COLLECTION

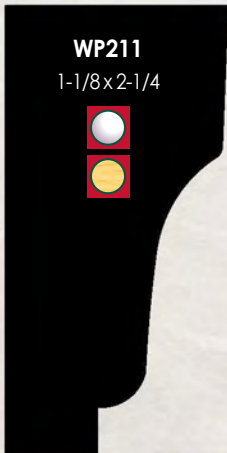

THE METRO
COLLECTION

NECK MOULDINGS

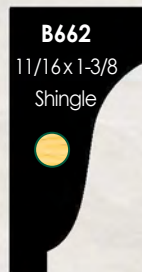
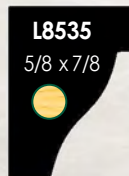
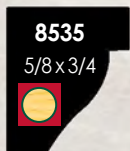

All profiles are available in select hardwood species on a special order basis. Actual profiles may vary slightly from what is shown.





DENTIL CROWNS

DENTIL MOULDINGS

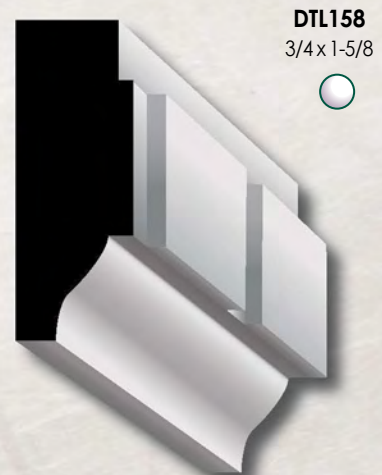
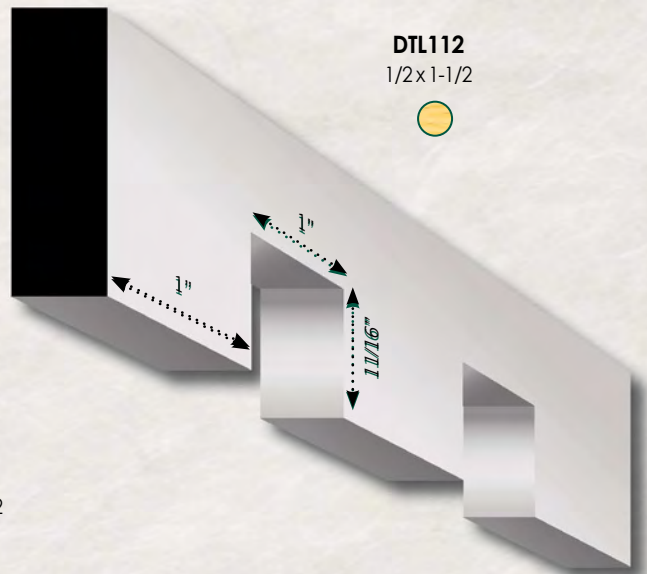
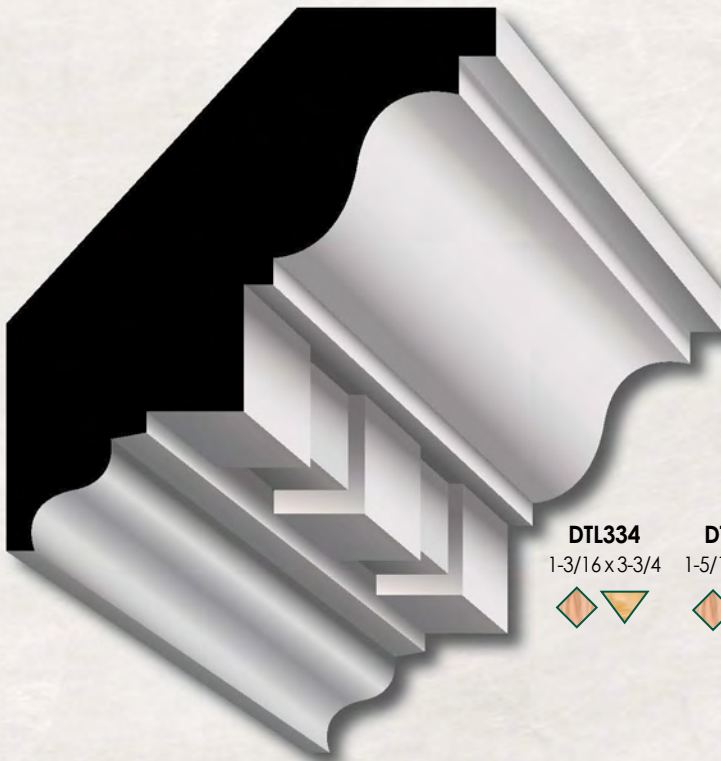

DTL512

CROWNS/COVES HEIGHTS & PROJECTIONS



UC71 Crown & PLB612

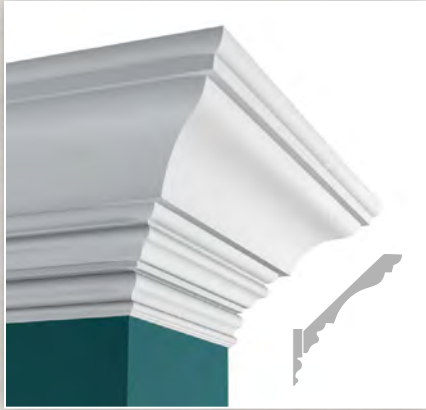

PLC812 & CB312



GSC614 & GSB412 (ceiling and wall)



GSC512 & GSB412 (ceiling and wall)

SKU#	HEIGHT	PROJECTION
Primed Pine Crowns/Coves		
L8010	2	1-3/8
WM53	2	1-3/16
L8009	2-1/2	2-5/16
COV312	2-1/2	2-1/2
LWM49	2-15/16	2-1/8
UC31	2-1/2	2-5/8
L8013	3-1/2	2-5/8
8013*	3-1/2	2-1/2
COV412	3-1/4	3-1/8
LWM47	3-5/8	2-3/4
WM47	3-5/8	2-5/8
UC41	3-1/4	3-1/8
8027	3-7/8	3-1/8
SBC514	3-7/8	3-7/8
BC5	3-1/2	3-3/4
UC51	3-7/8	3-3/4
UC71	5-1/4	5-1/8
COV7	5-1/4	5-1/4
Prestige Line – MDF		
LWM49	2-3/4	2-1/2
UC31	2-7/8	2-1/4
GSC412	3-5/8	2-3/4
LWM47	3-1/4	3-1/4
UC41	3-1/4	3-5/16
8027	3-3/4	3-5/8
GSC512	3-15/16	3-15/16
UC51	4	4
GSC614	4-7/16	4-7/16
PLC99MDF	4-3/4	4-1/4
PLC612	4-1/2	4-5/8
PLC634	4-3/4	4-13/16
UC71	5-1/4	5
GSC738	5-7/16	5-1/16
PLC712	5-1/4	5-1/4
PLC812	6-1/8	5-7/8
PLC1012	7-1/2	8
The Metro Collection		
MCOV5	3	3
MCR514	3-7/8**	3-1/2**
MCOV6	3-5/8	3-5/8
MCR714	5-1/2**	4-5/8**
MCOV8	5-1/16	5-1/16
The Designer Collection		
DCR512	3-7/8	4
DCR558	4	4
DCR612	4-3/4	4-1/2
DCR634	5-1/8	4-1/2
DCR725	5-1/8	5-1/4
DCR734	5-1/2	5-1/2
DCR814	5-1/2	6-1/8



UC71 Crown & BB6 Base



UC51 Crown & BB7 Base



UC41 Crown & ES3 Casing



UC31 Crown & BB458 Base

*available in clear pine only ** MCR514 and MCR714 reverse dimensions for wall step use

All profiles are available in select hardwood species on a special order basis. Actual profiles may vary slightly from what is shown.



A close-up photograph of white, decorative chair rail molding. The molding features a rounded top edge and a decorative flange. A white rectangular box with a thin red border is centered over the molding, containing the text "CHAIR RAILS" in red, uppercase letters.

CHAIR RAILS

CHAIR RAILS –
CAMELBACK

CHAIR RAIL –
NORMAN

CHAIR RAILS –
BEADED

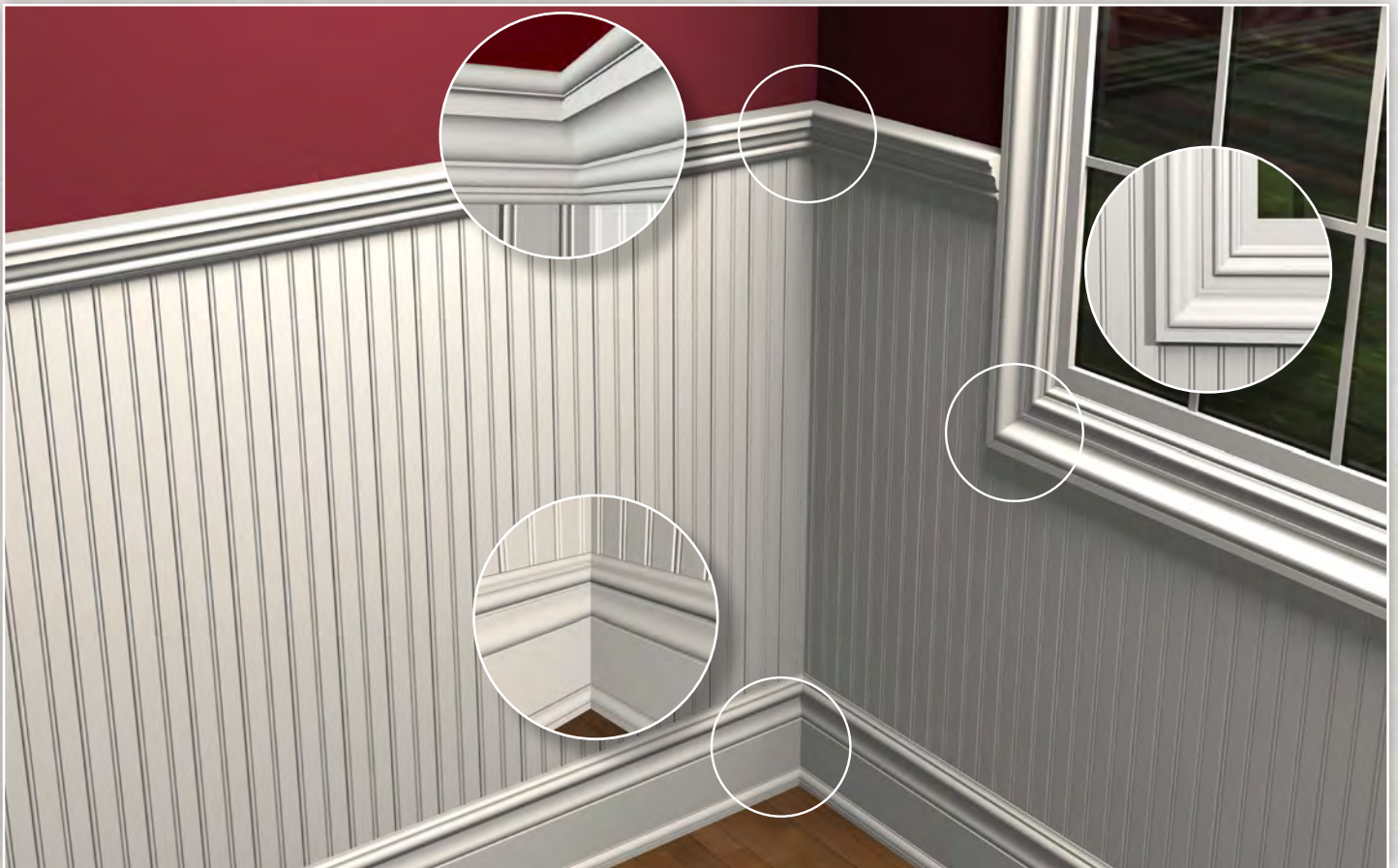

8121 Bull Nose w/SC214 Solid Crown, SB158VB Beadboard, GSB725 Base, SH1 Shoe, GS425 Casing

All profiles are available in select hardwood species on a special order basis. Actual profiles may vary slightly from what is shown.



CHAIR RAIL – PRESTIGE LINE, ESTATE SERIES,
& DESIGNER COLLECTION

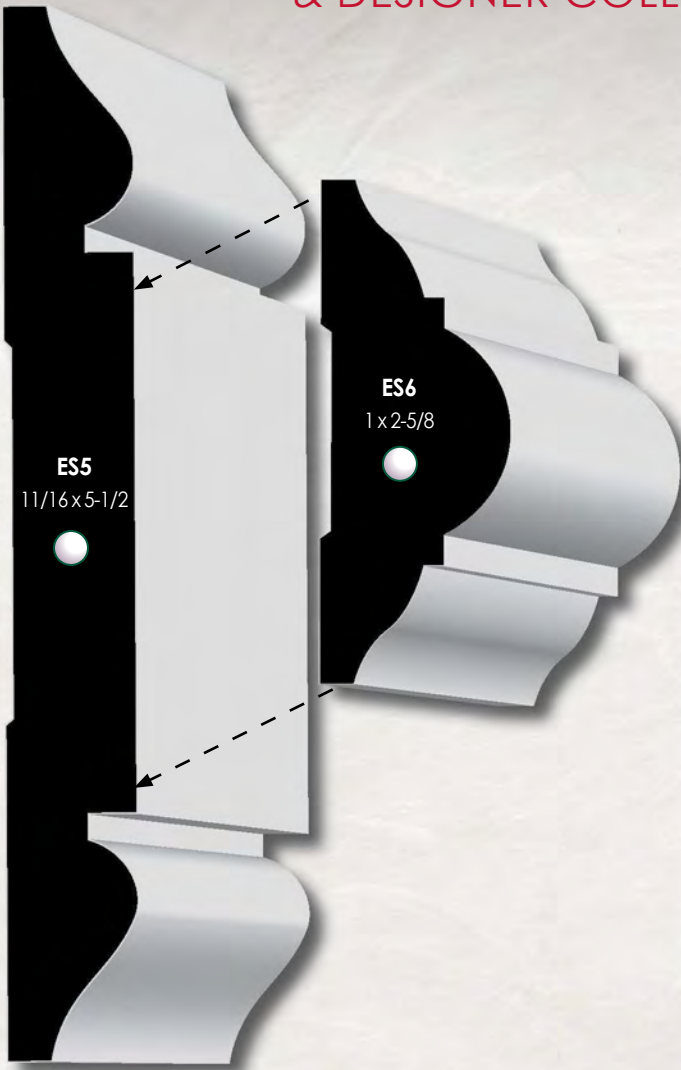

DCAS5 used as a Chair Rail



ES5 & ES6

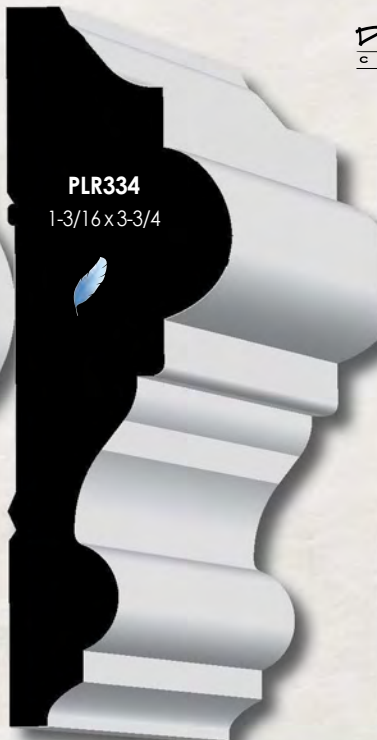

PLR334

The DESIGNER COLLECTION

BASE CAP/PANEL



ECB Cap

1x8

BC78

Drywall

BC78

1x12

BC78

1x6

ECB Cap, BC78 Panel, BC78 Base Cap, 1" x 4"-6"-12", and JC412 Casing



All profiles are available in select hardwood species on a special order basis. Actual profiles may vary slightly from what is shown.



PINE



PRIMED



OAK



ULTRALITE MDF



PRIMED POPLAR



POPLAR



PVC



RED BOX = IN STOCK



ES8 Chair Rail, PL2 Panel & BB6 Base – Radius corners of the 8416 (8416RCMDF), PL134 (PL134RCMDF) and PL 2 (PL2RCMDF) shown here are available in packs of 4 in MDF.

BASE CAP/PANEL

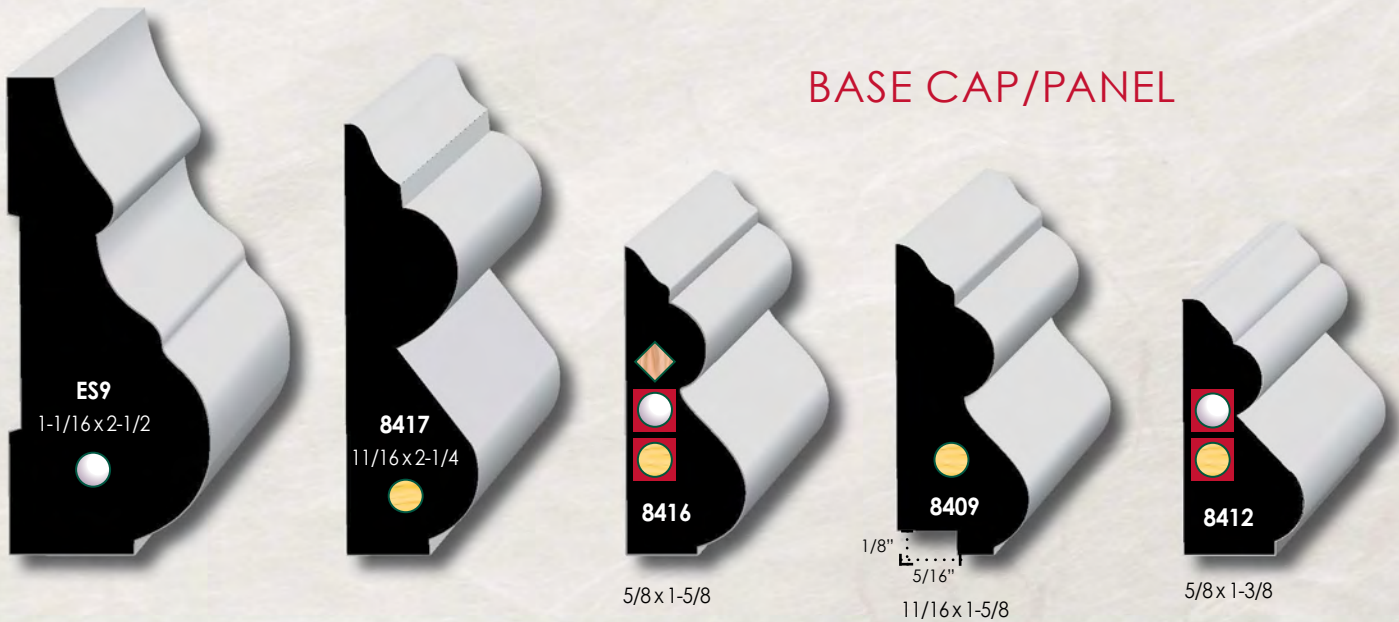

PANEL MOULDINGS

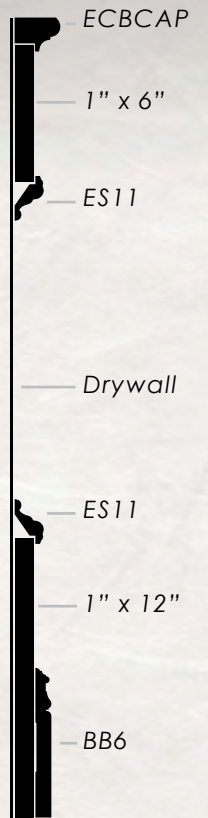

1" x 4", 1" x 6", 1" x 12", BB6 Base, ECBCAP & ES11 Panel Moulding

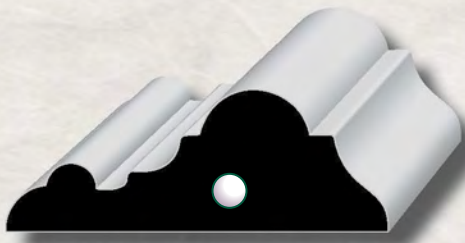

PL2 3/4x2

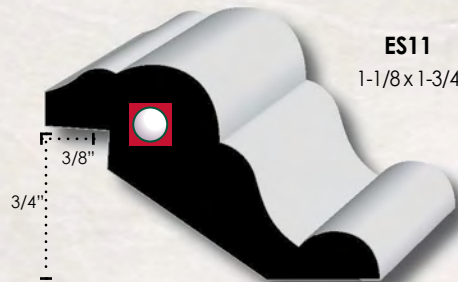

ES11
1-1/8x1-3/4

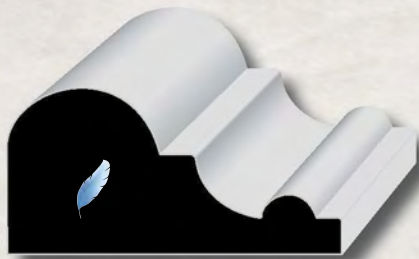

BS134 7/8x1-3/4



ES15
7/8x1-3/4



PL134 5/8x1-3/4

All profiles are available in select hardwood species on a special order basis. Actual profiles may vary slightly from what is shown.



NOSE & COVES

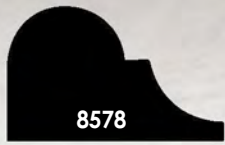

11/16x1-1/8

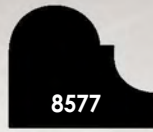

5/8x3/4

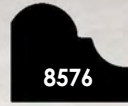

1/2x5/8



3/8x1/2



PANEL MOULDINGS

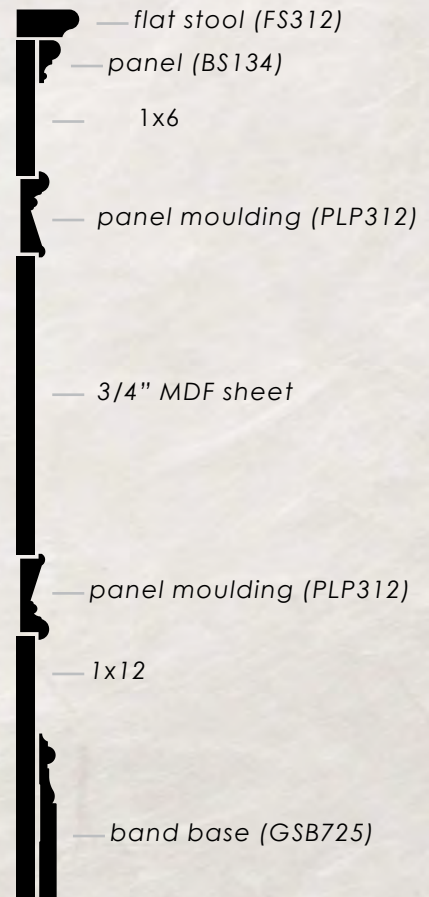

PLP312 Panel, BB7 Base, 1" x 12", 1" x 6" and 1" x 5" Precision Poplar S4S,
3/4" Ultra Lite MDF Panel

BASE CAP/PANEL

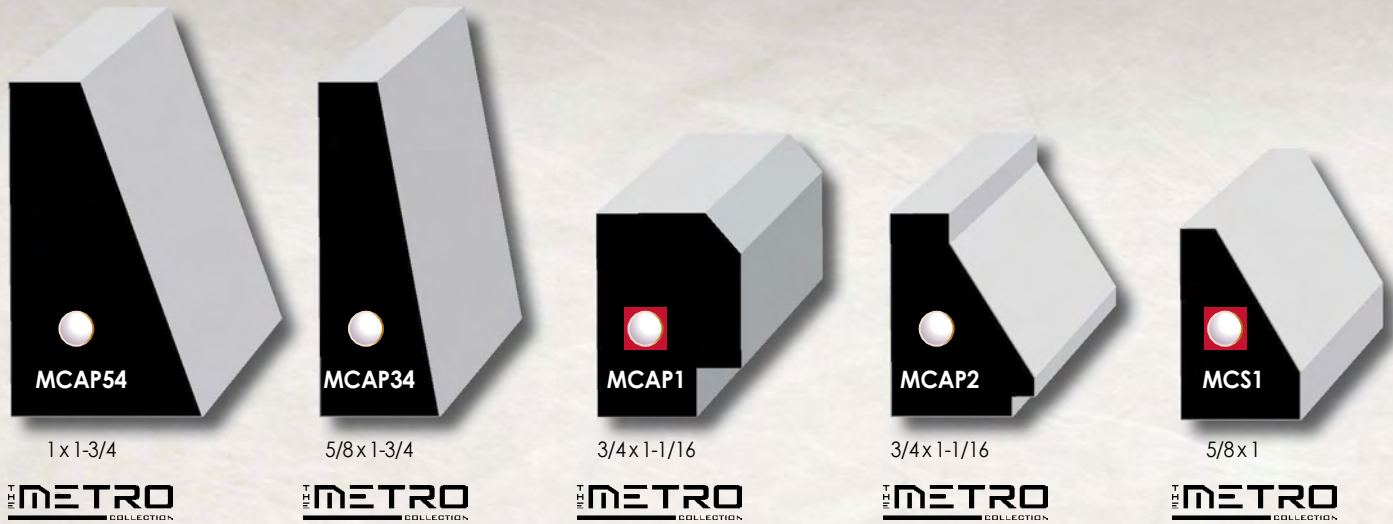

BASE CAP/PANEL USED IN BASE APPLICATIONS



MCS1 Shoe used as cap, 1" x 6", MCS1 Shoe Moulding



MCAP2 Cap, 1" x 6", MCS1 Shoe Moulding



MCAPI Cap, 1" x 8", MCS1 Shoe Moulding



MCAP34 Cap, 1" x 6", MCS1 Shoe Moulding

All profiles are available in select hardwood species on a special order basis. Actual profiles may vary slightly from what is shown.



METRO COLLECTION PANEL APPLICATION



MCP54, MCS1, 1" x 6", 1" x 12"

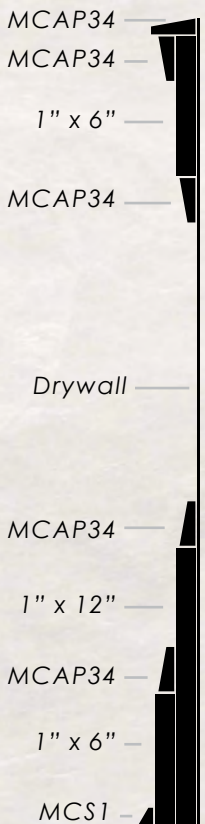

MCP34, 1" x 6", 1" x 12"

METRO COLLECTION PANEL APPLICATION

- 1" x 3" —
- MSC175 —
- 1" x 6" —
- MCAP2 —
- MCAP2 —
- 1" x 4" —
- MCAP2 —
- Drywall —
- MCAP2 —
- 1" x 10" —
- MCAP2 —
- 1" x 5" —
- MCS1 —



MSC175, MCAP2, MCS1, 1" x 3", 1" x 4", 1" x 5", 1" x 6", 1" x 10"

- 8121 —
- MSC225 —
- 1" x 6" —
- MCAP1 —
- Drywall —
- MCAP1 —
- 1" x 12" —
- MCB712 —
- MCS1 —



8121, MSC225, MCAP1, MCB712, MCS1, 1" x 6", 1" x 12"

All profiles are available in select hardwood species on a special order basis. Actual profiles may vary slightly from what is shown.



EDGE & CENTER BEAD CAP



WAINSCOT CAPS

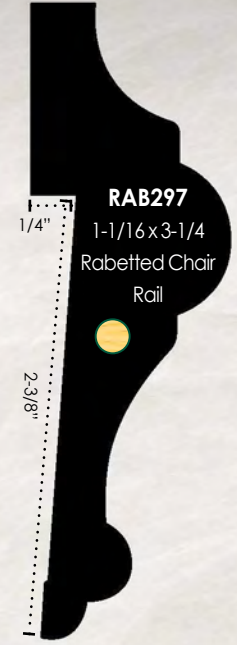
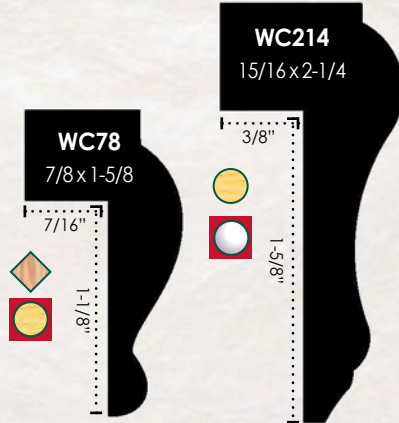

nomtucket®
beadboard

See pages 102-118 for our full offering of Beadboard Panels and Strip Products

Beadboard on the wall: 1218 CH Strip 4" Beadboard on the ceiling: 1218 CH Strip 8-1/4", Crown: COV312 Base: BB7, Casing: ES12

ASTRAGALS & MULLION CENTERS

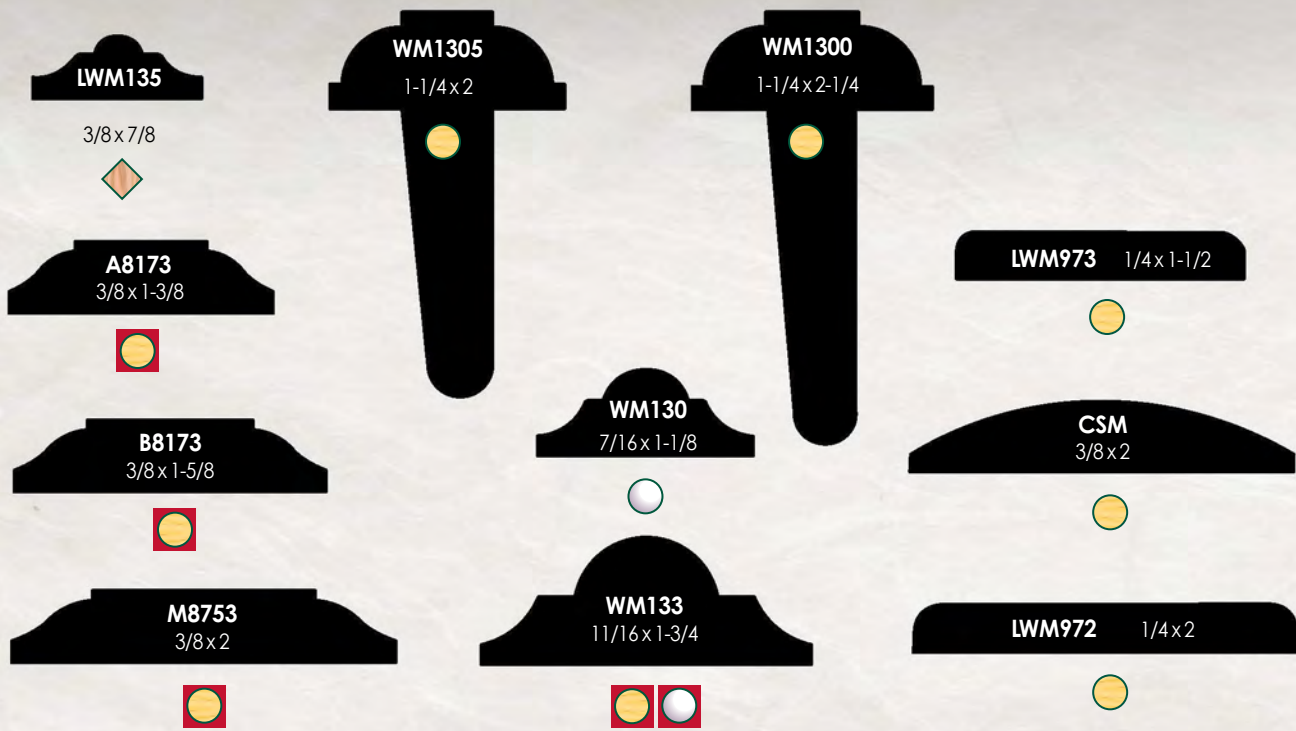

BALUSTERS

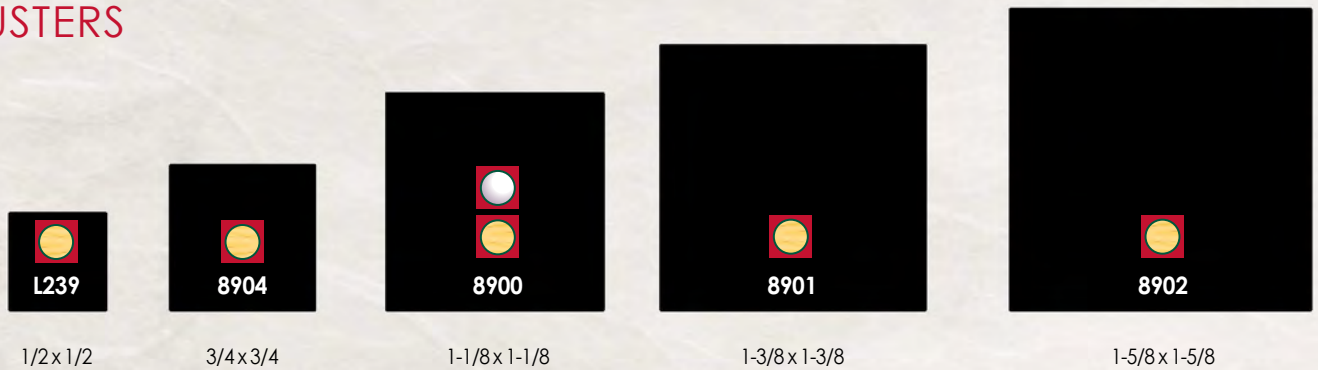

BAND / RAKE MOULDINGS

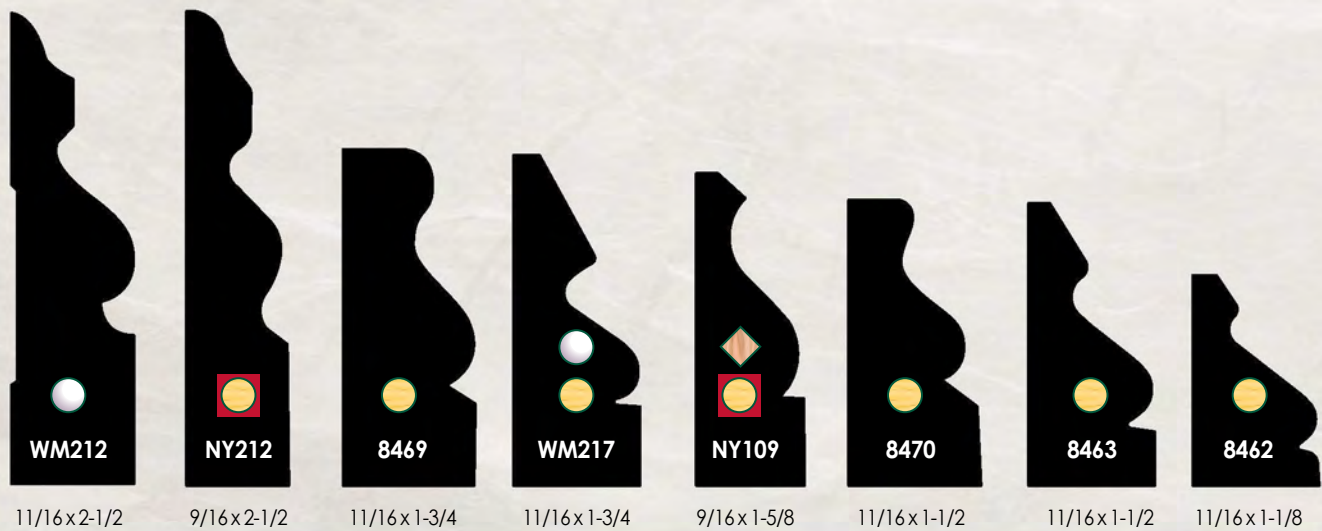

All profiles are available in select hardwood species on a special order basis. Actual profiles may vary slightly from what is shown.

PICTURE FRAME

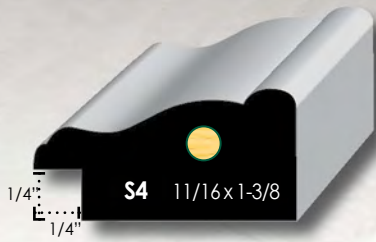

PICTURE MOULDINGS

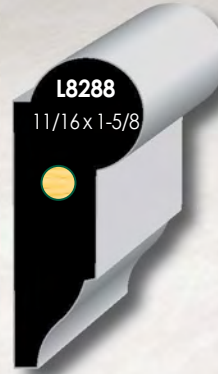
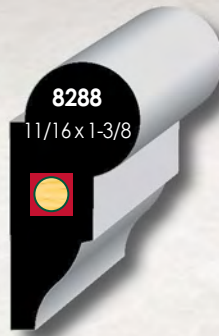

SKEW BACKS (CHAMFERS)

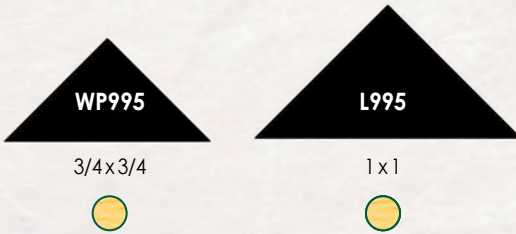

PARTING STRIP

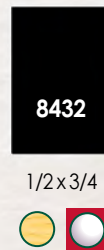

GLASS BEADS

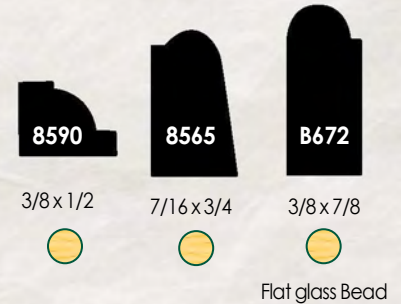

LATTICES

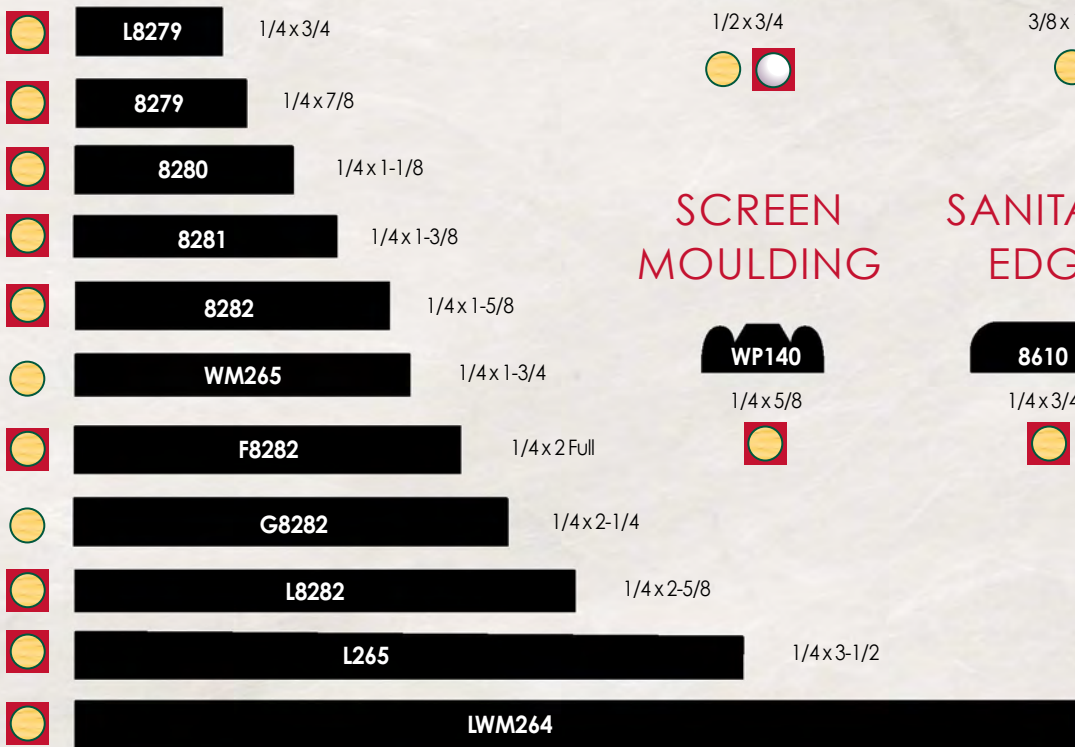

SCREEN MOULDING

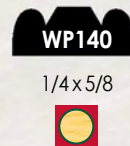

SANITARY EDGE



BEADED EDGE



1/2" X S4S

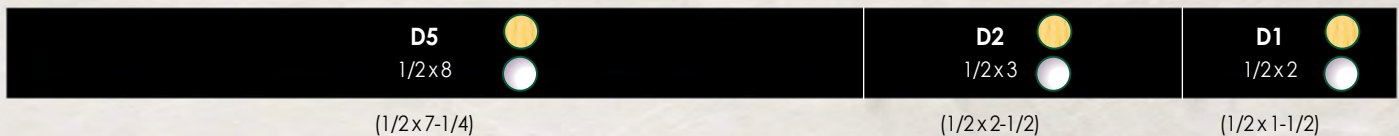

STOPS – CLAM SHELL



STOP – EXTERIOR



STOPS – COLONIAL



STOP – GARAGE DOOR

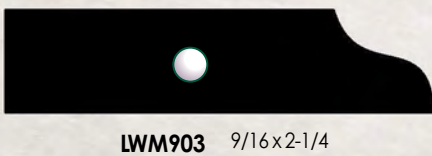

BULLNOSE

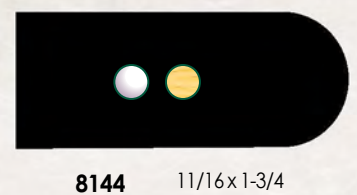

STOPS – SANITARY

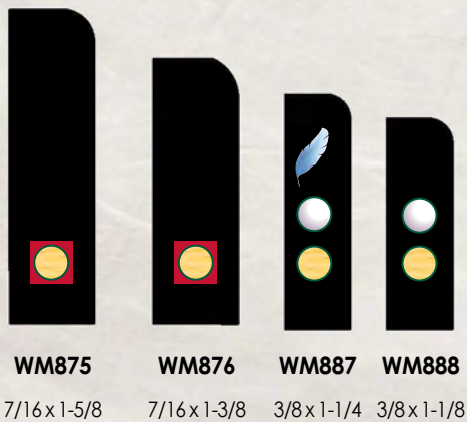

STOPS – BULLNOSE

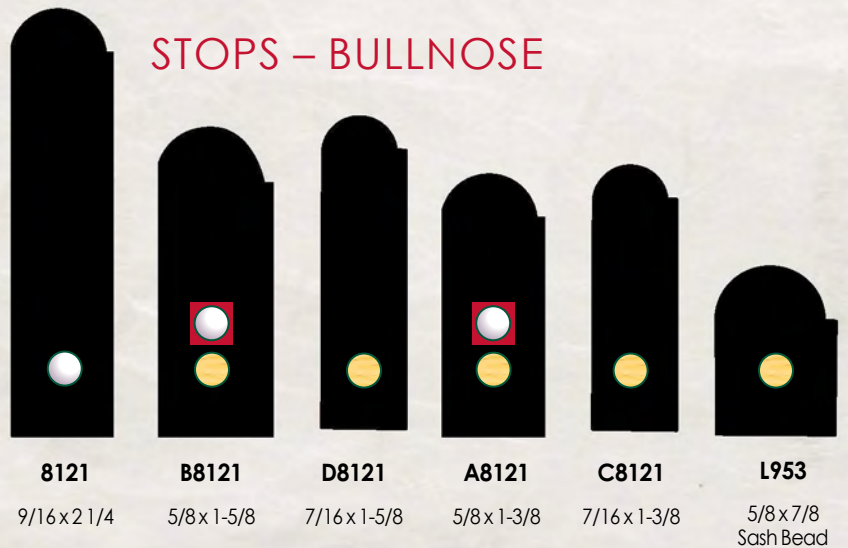

All profiles are available in select hardwood species on a special order basis. Actual profiles may vary slightly from what is shown.

POLES



P214 2-1/4	F8913 1-5/8	F233 1-5/16
F8912 1-3/8	F8911 1-1/8	8908 3/4

HALF ROUNDS

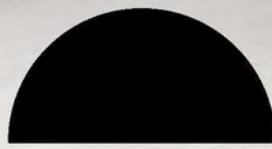

L8080 1-1/8x2-1/4	8080 11/16x1-5/8	8073 11/16x1-3/8	8072 9/16x1-1/8
8071 7/16x7/8	8077 3/8x3/4	8076 5/16x5/8	8070 1/4x1/2

QUARTER ROUNDS



8068 1-1/8x1-1/8	8066 7/8x7/8	8065 3/4x3/4	L8065 11/16x11/16
8064 5/8x5/8	8063 1/2x1/2	8058 3/8x3/8	8057 1/4x1/4

OVAL HAND RAIL



HAND RAIL



HAND RAIL

KEYHOLE

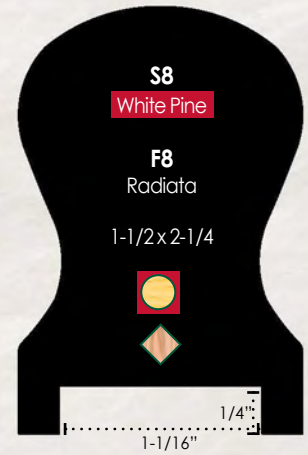

PORCH RAIL – TOP



PORCH RAIL – BOTTOM

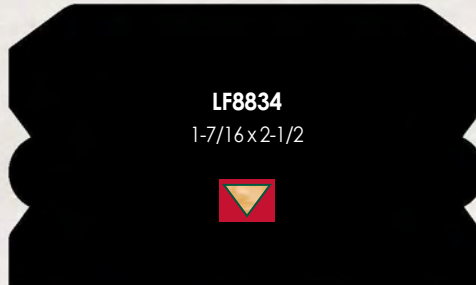

FLAT BOTTOM RAIL



CHICAGO BAR RAIL



SANITARY CORNER GUARDS

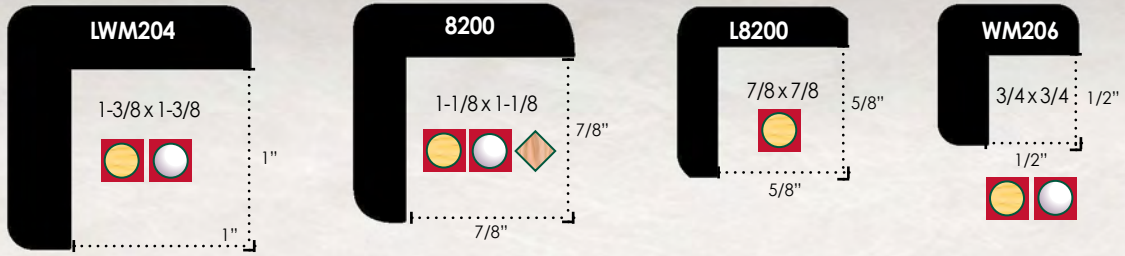

COLONIAL CORNER GUARDS

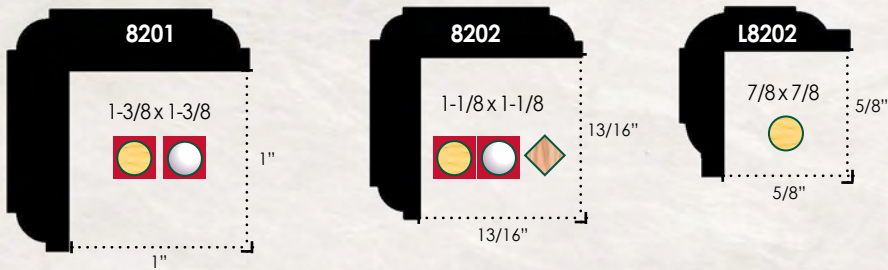

SANITARY CAPS



DRIP CAPS



STEPPING



All profiles are available in select hardwood species on a special order basis. Actual profiles may vary slightly from what is shown.



EXTENSION JAMBS

CASEMENT

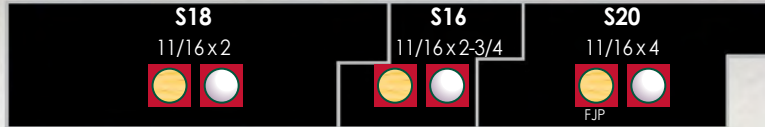

NARROWLINE



TILT WASH

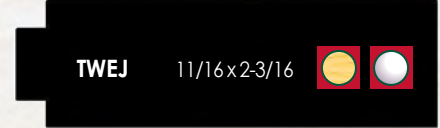

STOOL – NARROWLINE



STOOL – TILT WASH



STOOL – 200 SERIES

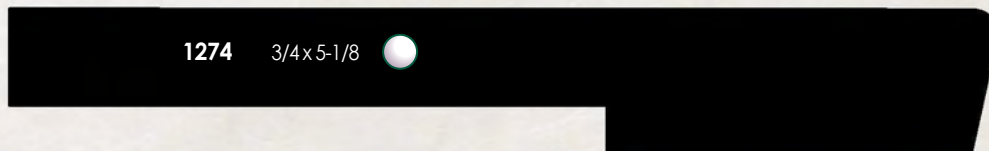

STOOL – RABETTED



STOOL – FLAT

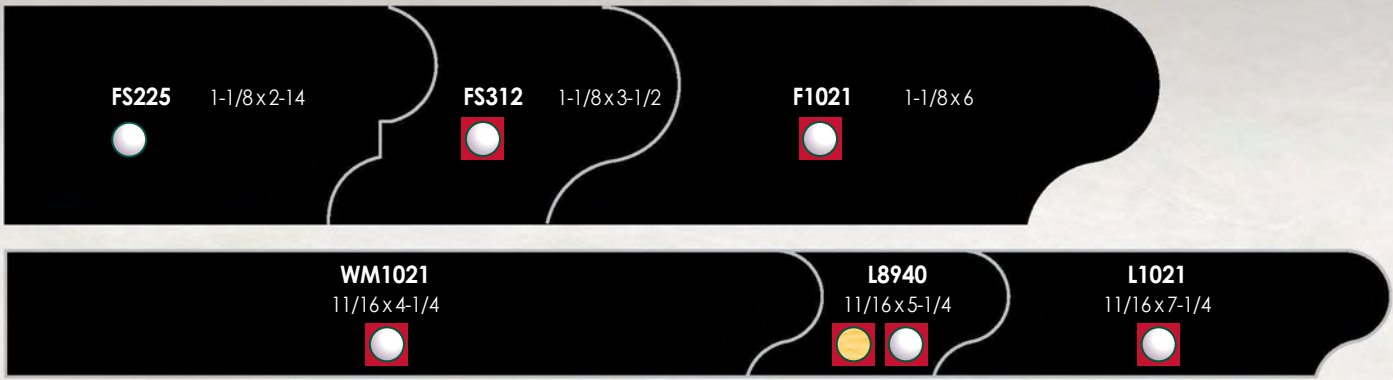

BULLNOSE



STOOL – CASEMENT



DOOR SILLS

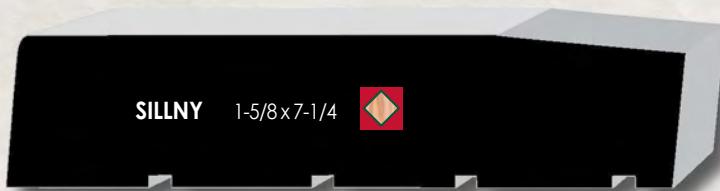

profile shown at 50%

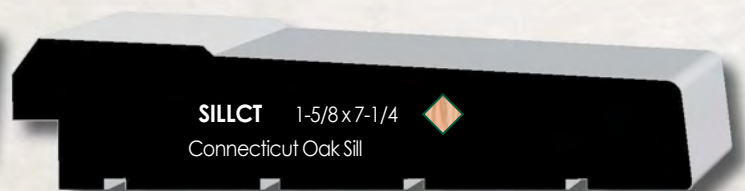

profile shown at 50%

WINDOW SILLS

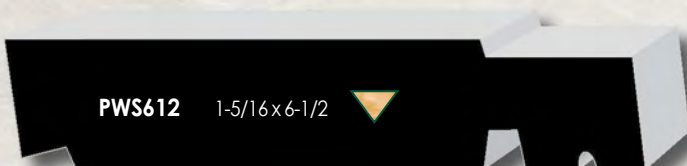

profile shown at 50%

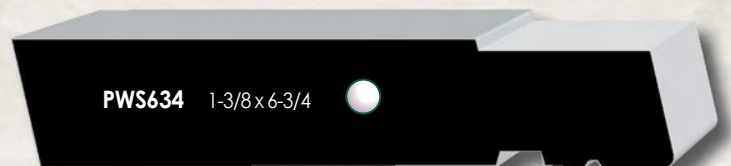

profile shown at 50%

All profiles are available in select hardwood species on a special order basis. Actual profiles may vary slightly from what is shown.



MANTEL



ES10
 1-5/8 x 5-5/8

OAK HEARTH BORDER

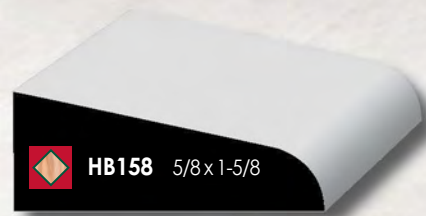

HB158 5/8 x 1-5/8

LANDING TREADS

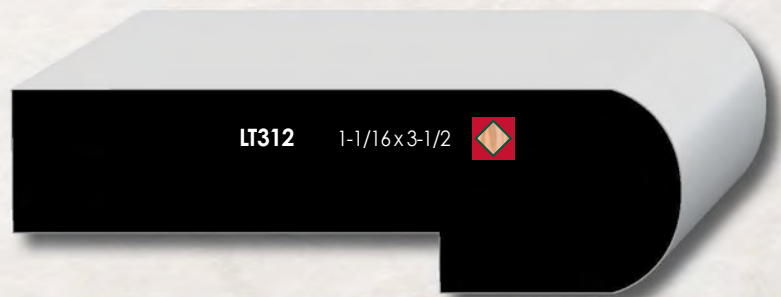

LT312 1-1/16 x 3-1/2

OAK SADDLES

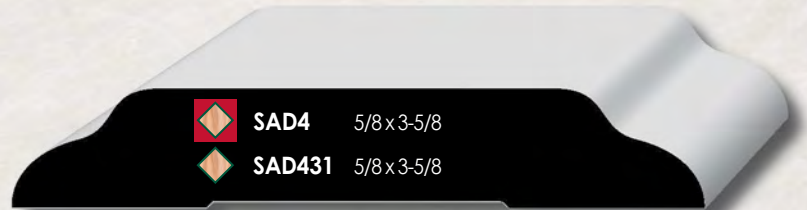

SAD4 5/8 x 3-5/8
SAD431 5/8 x 3-5/8

OAK NOSING



N138
 1-1/16 x 1-3/8

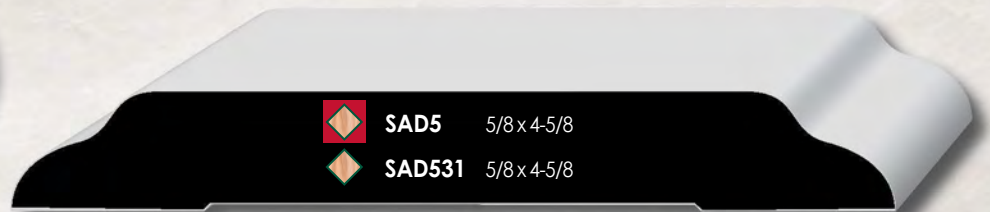

SAD5 5/8 x 4-5/8
SAD531 5/8 x 4-5/8

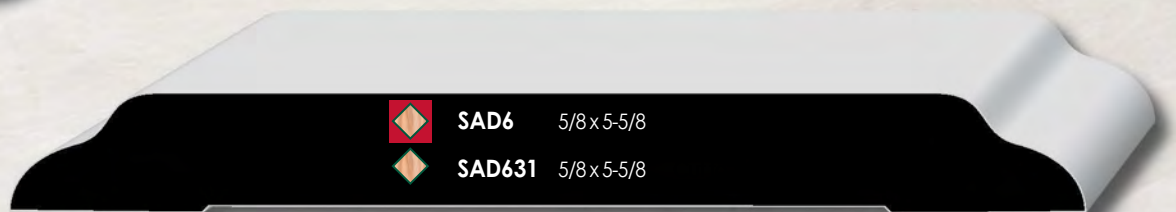

SAD6 5/8 x 5-5/8
SAD631 5/8 x 5-5/8



Heritage[®] WIDE PLANK FLOORING & Millwork

Featured: American Black Walnut

All profiles are available in select hardwood species on a special order basis. Actual profiles may vary slightly from what is shown.



HERITAGE WIDE PLANK FLOORING & MILLWORK - SEMI-CUSTOM

The profiles on the next several pages are industry standards run from 5/4" material of your choice. These mouldings are thicker than our stock profiles, with styling that complements the architecture of fine homebuilding. These profiles can be run to order in any species of wood, as well as PVC or MDF. For paint grade mouldings, we recommend poplar.

Bridging the gap between our stock profiles and full custom profiles that require the creation of new knives, the knives for these mouldings are on hand and ready to be used on your next order. You get the custom look you want, in the material of your choice, with a quick turnaround and no added expense for custom knives.



available exclusively at

RIVERHEAD
BUILDING SUPPLY

SEMI-CUSTOM MOULDINGS

All mouldings run in our custom millwork shop. Available within a short lead time.

BASES



BASE CAPS



All profiles are available in select hardwood species on a special order basis. Actual profiles may vary slightly from what is shown.



CASINGS



BASE CAPS

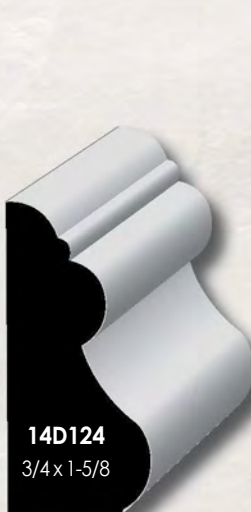

BACK BAND



SEMI-CUSTOM MOULDINGS

All mouldings run in our custom millwork shop. Available within a short lead time.

CROWNS



All profiles are available in select hardwood species on a special order basis. Actual profiles may vary slightly from what is shown.



CROWNS

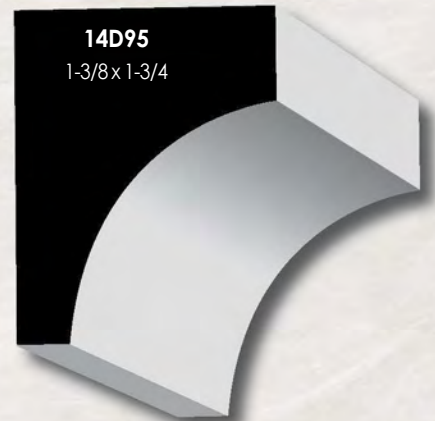

COVES

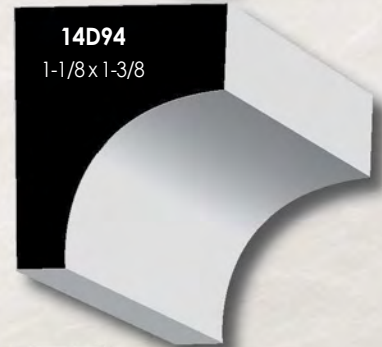
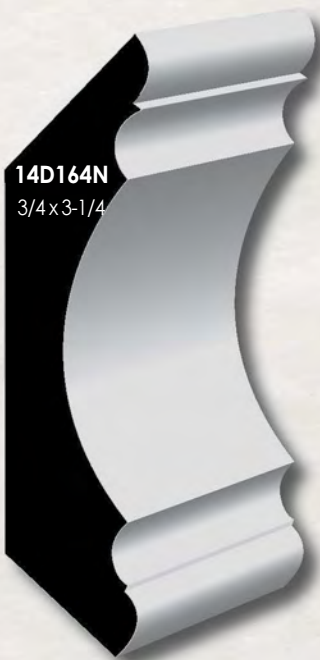

SEMI-CUSTOM MOULDINGS

All mouldings run in our custom millwork shop. Available within a short lead time.

SOLID CROWNS

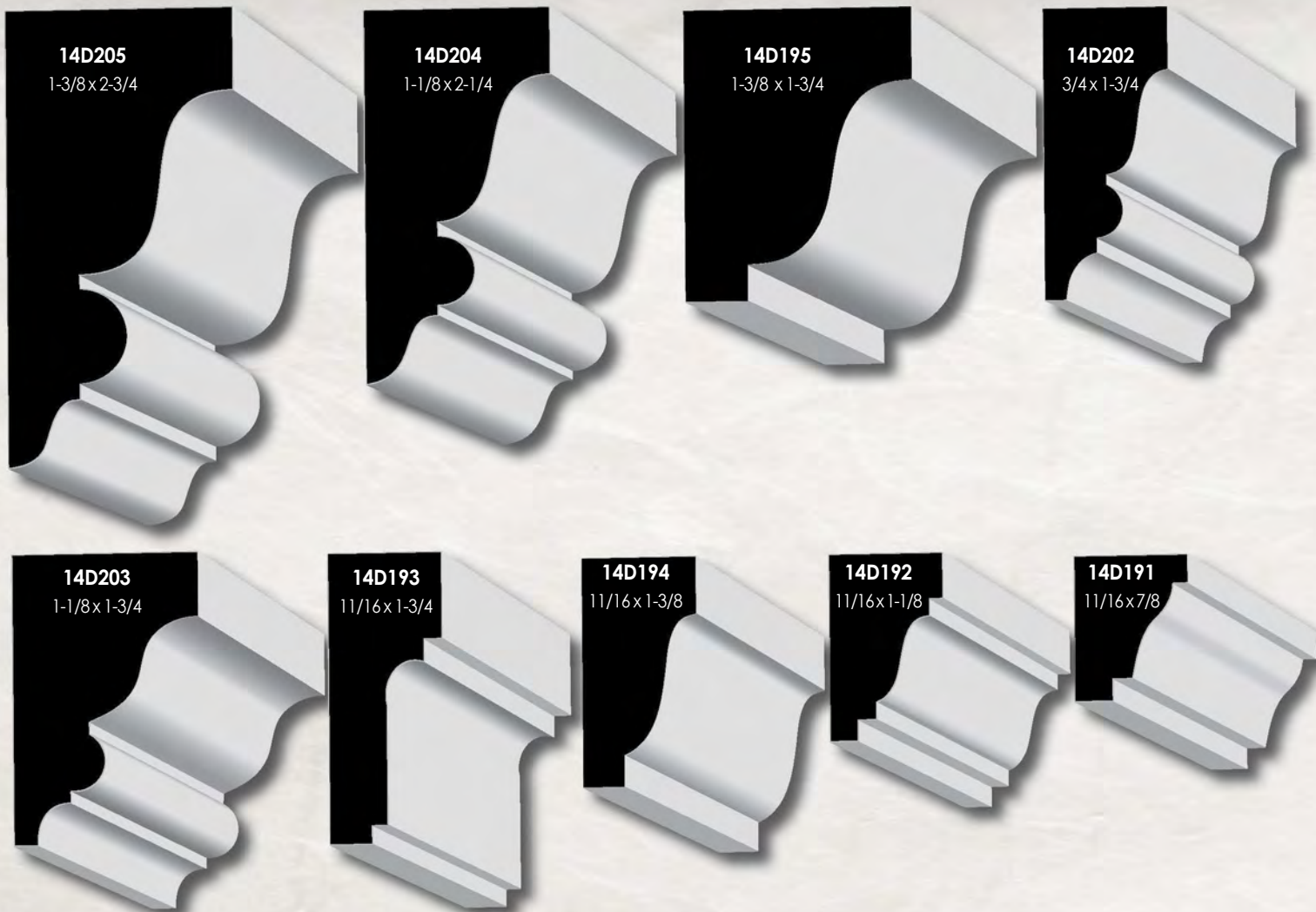

NOSE & COVE

PICTURE MOULDING

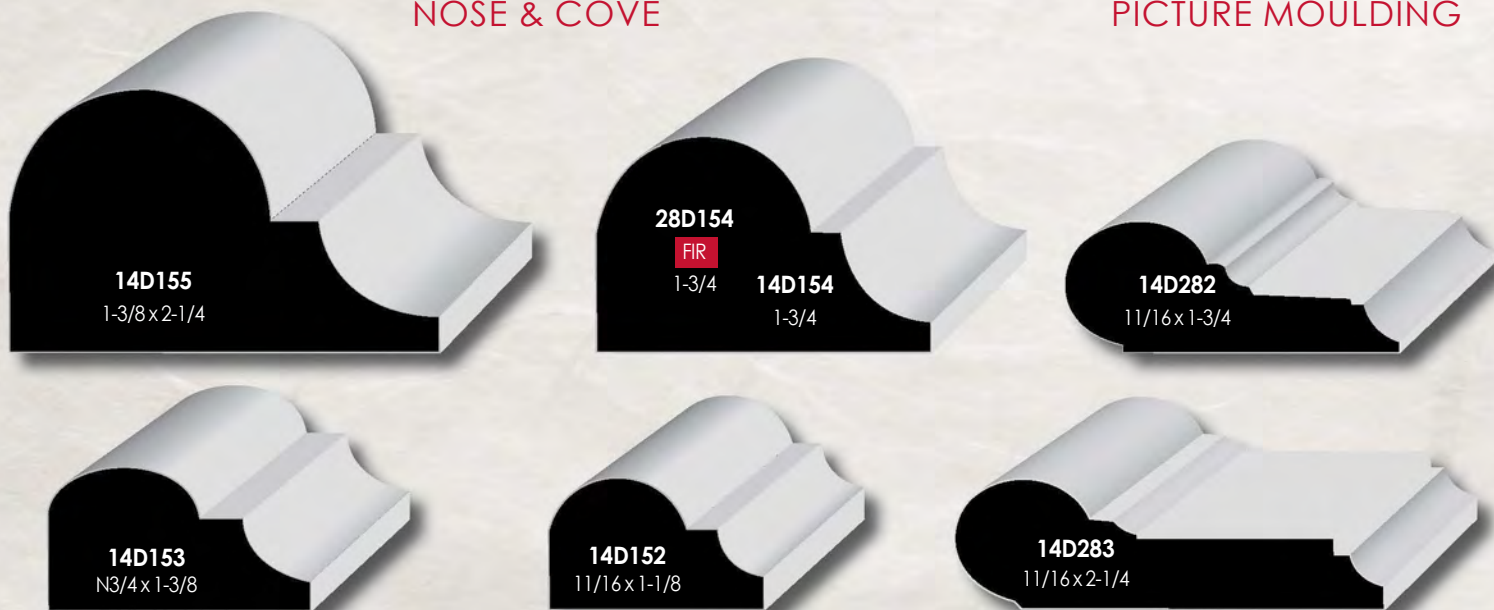

All profiles are available in select hardwood species on a special order basis. Actual profiles may vary slightly from what is shown.



CHAIR RAIL

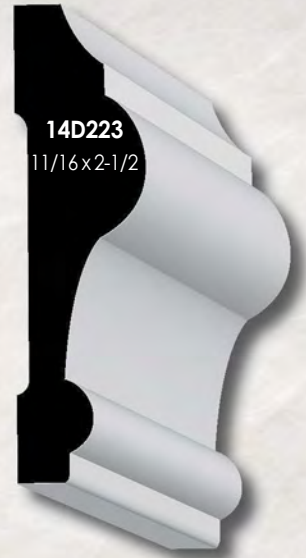

PANEL



ASTRAGAL



SHOE



GLASS BEAD



VERSATEX®

TRIM BOARD PVC MOULDINGS



CROWNS



All profiles are available in select hardwood species on a special order basis. Actual profiles may vary slightly from what is shown.



SOLID CROWN

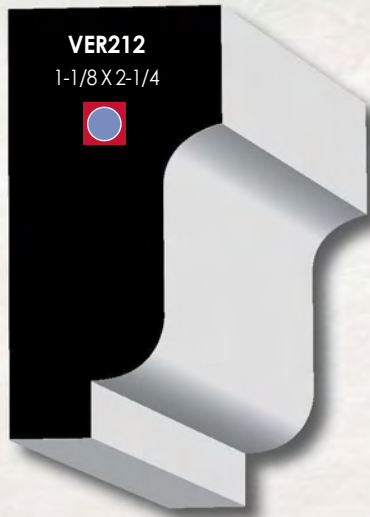

RAM'S CROWN



BED MOULD



SCOTIA COVE



PANEL

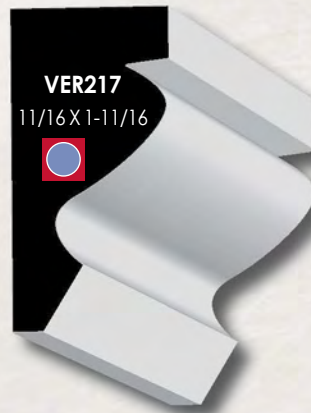

RAKE MOULD



NOSE & COVE



SHINGLE MOULD



DRIP CAP



CASING



QUARTER ROUND



T-MOULD

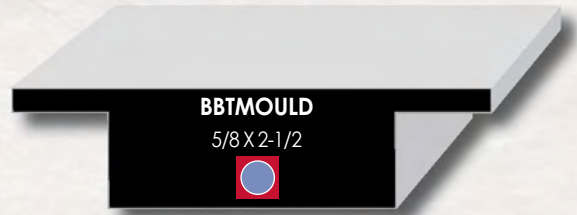

BACK BAND



BALUSTER



BASE CAP



BRICK MOULD



HISTORIC SILL



SUB SEAL NOSE

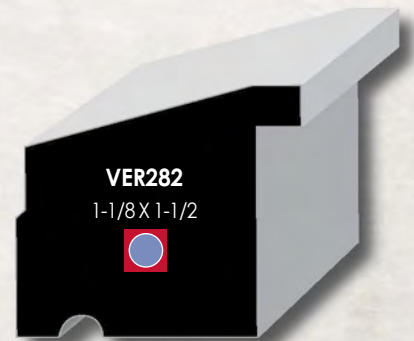

All profiles are available in select hardwood species on a special order basis. Actual profiles may vary slightly from what is shown.



BEADBOARD

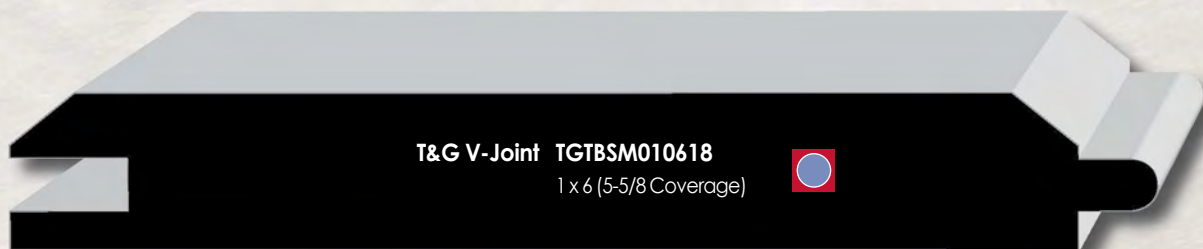
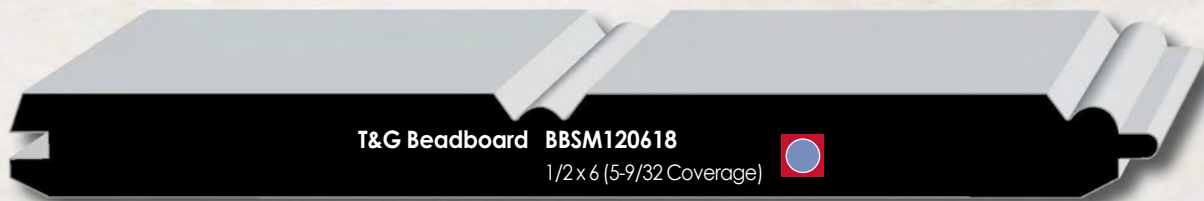



PRIMED PINE MOULDINGS

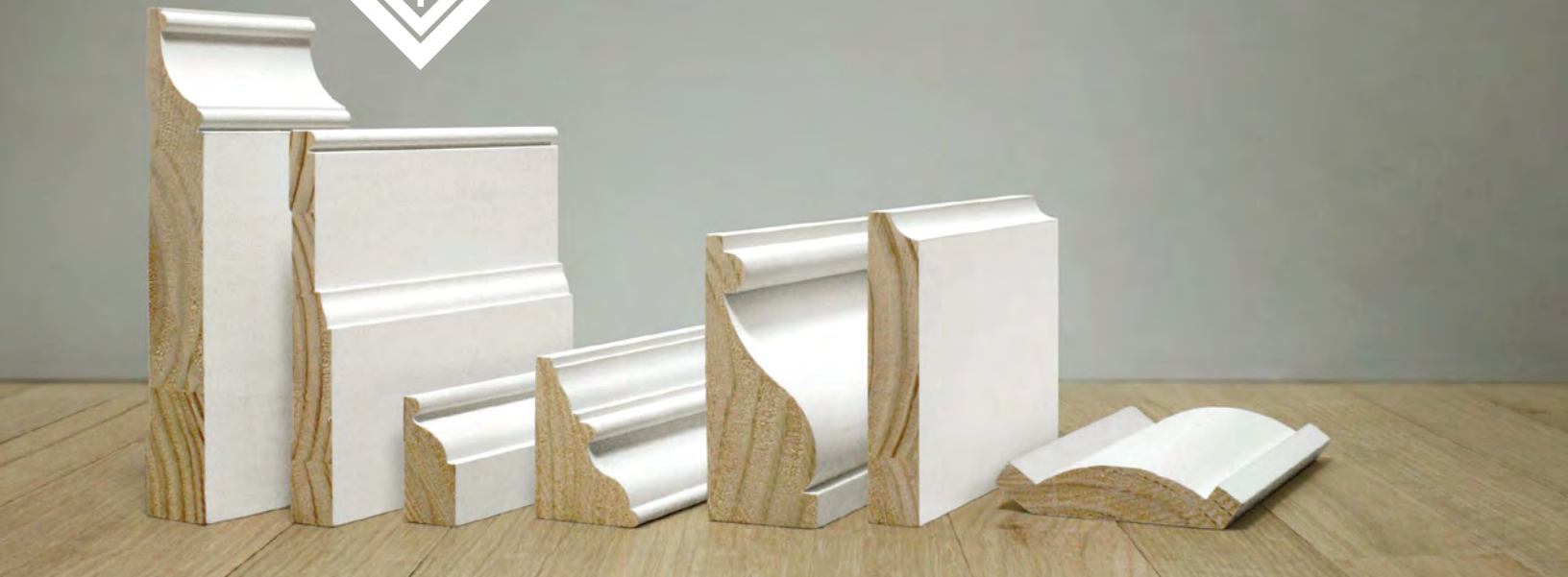

COLONIAL REVIVAL

WindsorONE profiles are sold in 16' lengths, except for casings which are 17'

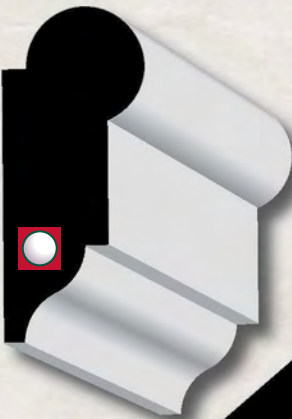

PICTURE
WOPM004
3/4 X 1-3/4



**SPRUNG CROWN/
COPE**
WOCM006
3/4 X 4-9/16



STOP
WOST004
1/2 X 1-7/8



**APRON/
CASING**
WOC S006
3/4 X 3-9/16



CASING
WOC S005
1-3/16 X 4-3/8

All profiles are available in select hardwood species on a special order basis. Actual profiles may vary slightly from what is shown.





CLASSICAL COLONIAL

WindsorONE profiles are sold in 16' lengths, except for casings which are 17'



BACK BAND
WOBB001
7/8 X 1-3/4



CHAIR RAIL
WOCH001
1-1/2 X 1-1/2



CROWN
WOCM001
3/4 X 3-19/32

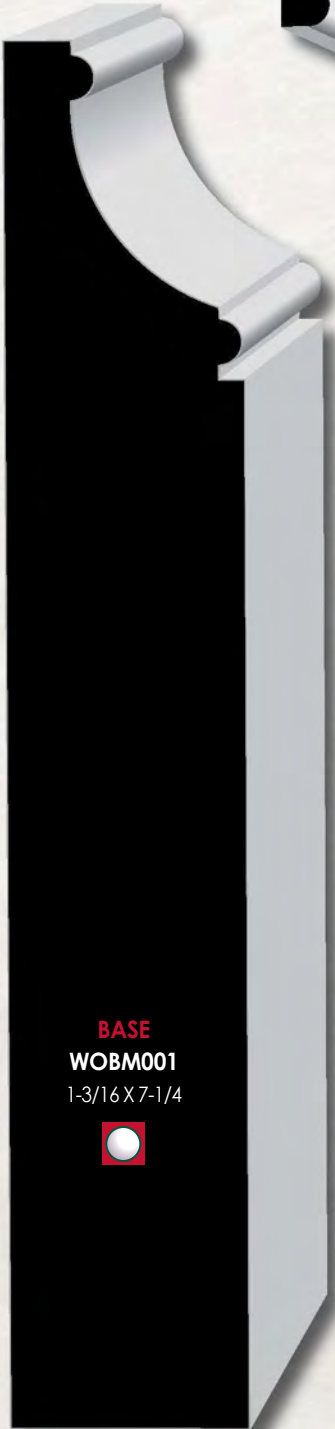

BASE
WOBM001
1-3/16 X 7-1/4



CASING
WOCM001
3/4 X 5-1/2



CROWN
WOCM003
1-5/8 X 4



CROWN
WOCM002
3/4 X 4-5/16





CLASSICAL CRAFTSMAN

WindsorONE profiles are sold in 16' lengths, except for casings which are 17'

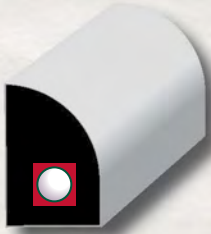

SHOE
WOBS001
1/2 X 3/4



STOP
WOST001
7/16 X 1-1/16



HEADER CAP
WOHC001
1-5/16 X 2-1/4

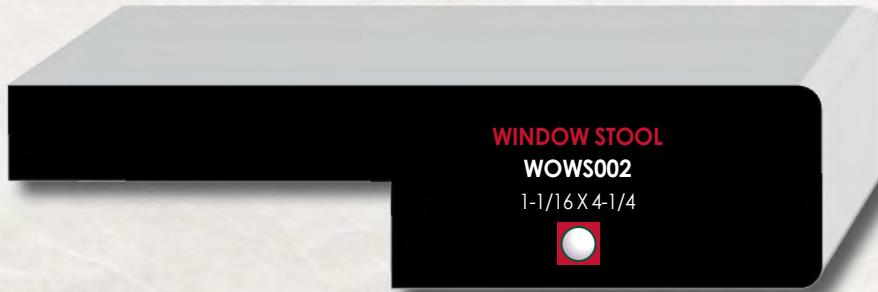

WINDOW STOOL
WOWS002
1-1/16 X 4-1/4

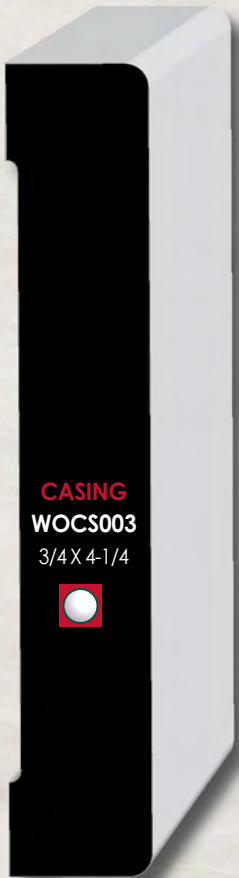

CASING
WOCs003
3/4 X 4-1/4



CASING
WOCs004
3/4 X 3-9/16

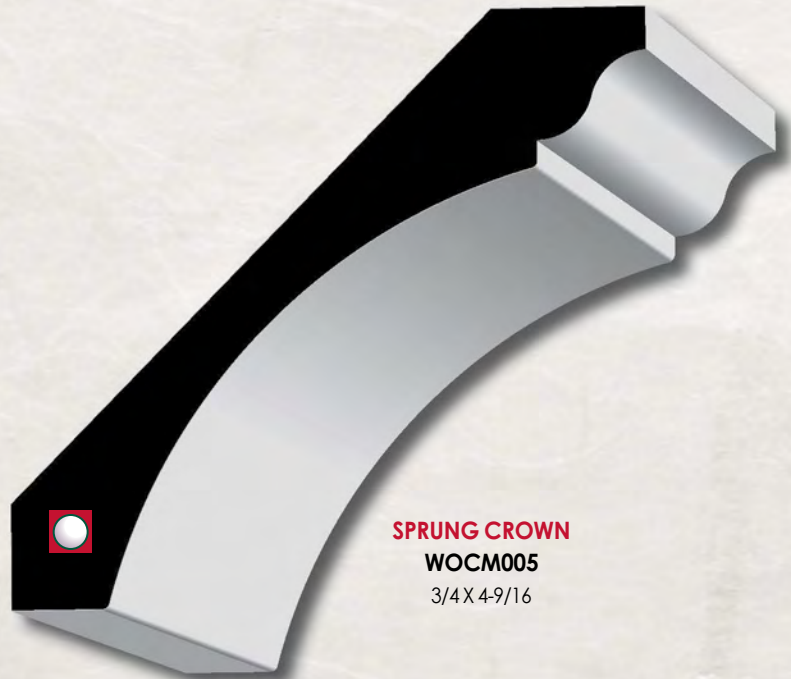

SPRUNG CROWN
WOCM005
3/4 X 4-9/16

All profiles are available in select hardwood species on a special order basis. Actual profiles may vary slightly from what is shown.





CLASSICAL CRAFTSMAN

WindsorONE profiles are sold in 16' lengths, except for casings which are 17'

Plinth block sold by the piece.



CASING
WOBM004
3/4 X 7-1/4



CASING
WOBM003
3/4 X 7-1/4



PLINTH BLOCK
WOPB001
1-3/8 X 8 X 4-1/2





GREEK REVIVAL

WindsorONE profiles are sold in 16' lengths, except for casings which are 17'

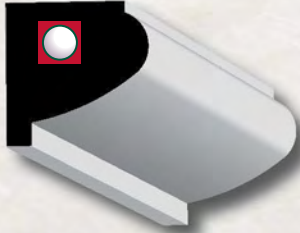

BACK BAND
WOBB002
3/4 X 3/4

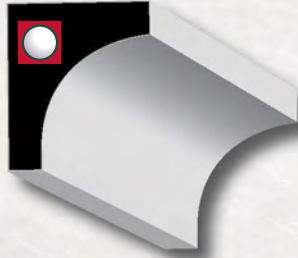

COVE
WOCV001
3/4 X 7/8



SPRUNG CROWN
WOCM004
1-1/16 X 4



BASE
WOBM002
3/4 X 5-1/2



BEADED CASING
WOCSS007
3/4 X 3-1/2



WINDOW STOOL
WOWS001
1-1/16 X 4-1/2

All profiles are available in select hardwood species on a special order basis. Actual profiles may vary slightly from what is shown.





STANDARD PROFILES

WindsorONE profiles are sold in 16' lengths, except for casings which are 17'

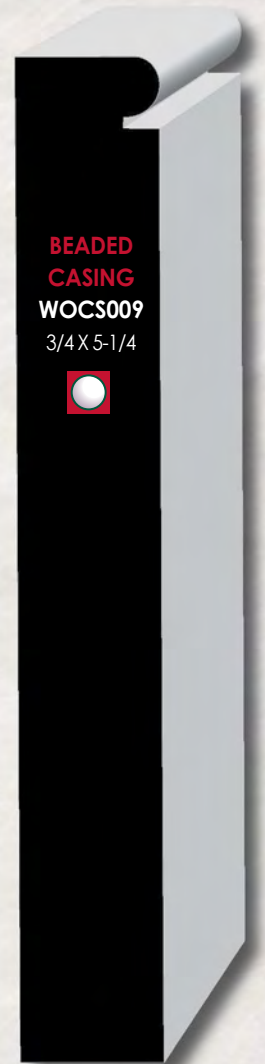
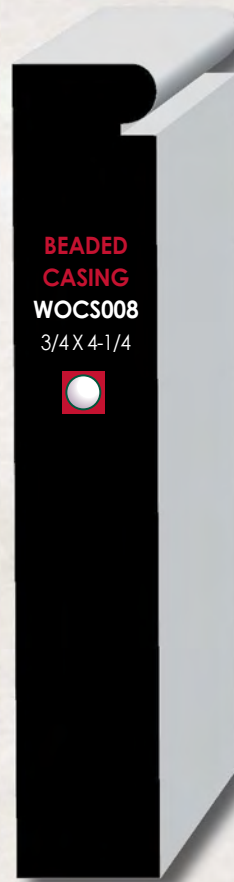



STANDARD PROFILES

WindsorONE profiles are sold in 16' lengths, except for casings which are 17'



DETAIL
WOSP001
7/8 X 1-1/4

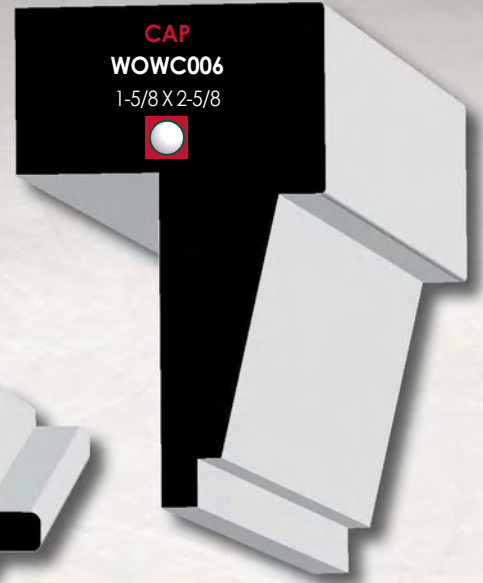

CAP
WOWC006
1-5/8 X 2-5/8



TONGUE & GROOVE
WOTG6
23/32 X 5-1/2

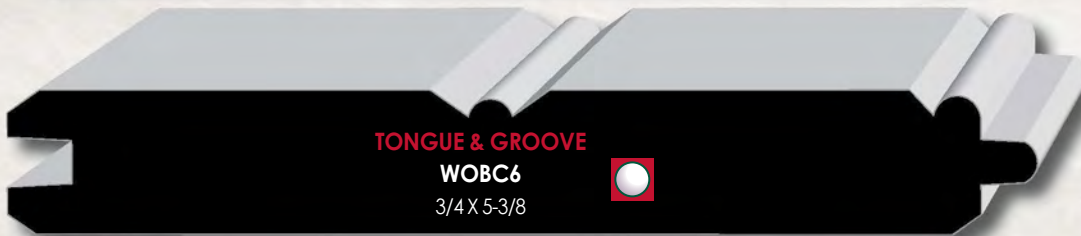

TONGUE & GROOVE
WOBG6
3/4 X 5-3/8



TONGUE & GROOVE
SPBC8
23/32 X 7-1/4



SPECIALTY SHIPLAP
WORS6
3/4 X 5-1/2

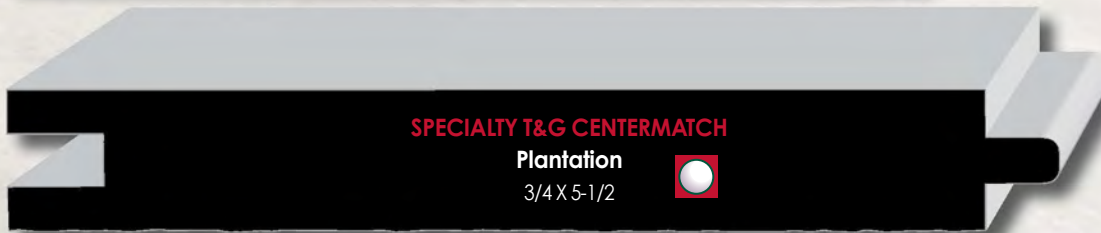

SPECIALTY T&G CENTERMATCH
Plantation
3/4 X 5-1/2

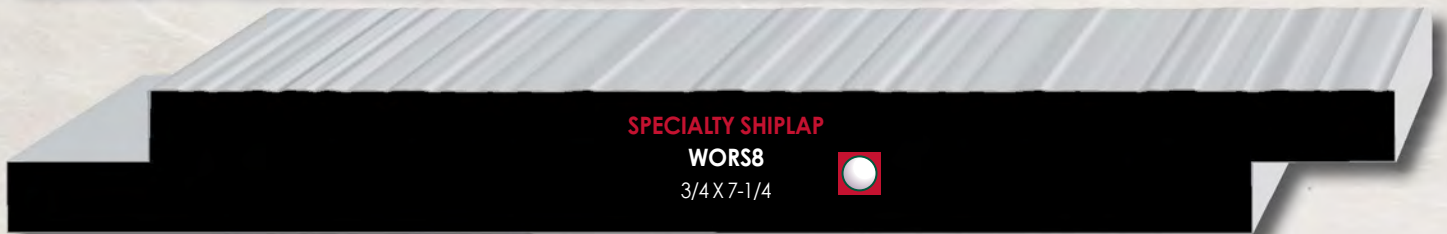

SPECIALTY SHIPLAP
WORS8
3/4 X 7-1/4



SHIPLAP

— & TONGUE & GROOVE BOARDS —

CRAFTSMANSHIP PAYS

available at



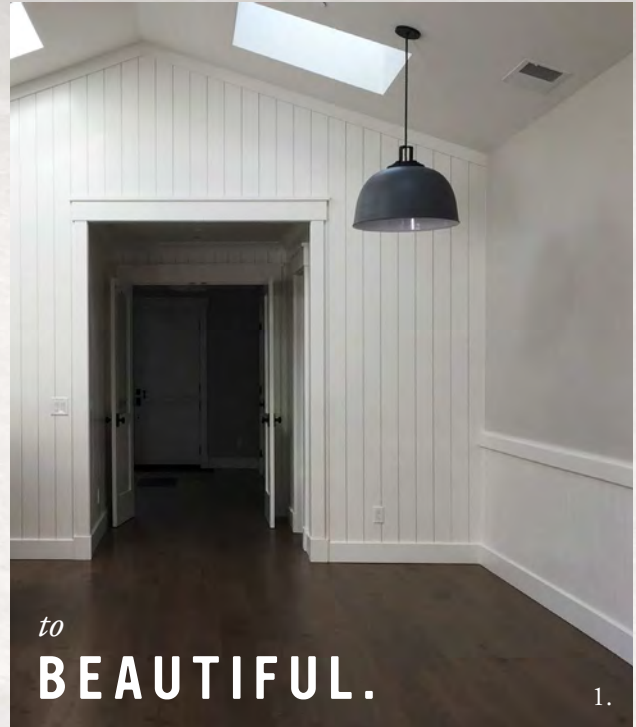

30 YEAR 30 YR LIMITED* WARRANTY
Protects against rot, insects & mold
Durable for the exterior, safe for the interior
Gold Indoor Air Quality Rating
& Weather Resistant System

1. KITCHEN by Streamline Builders in CA 2. PORCH LID by Woodsmith Construction LLC in NJ

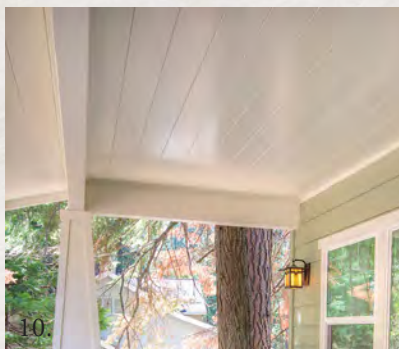
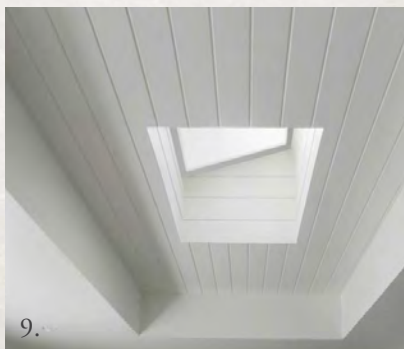
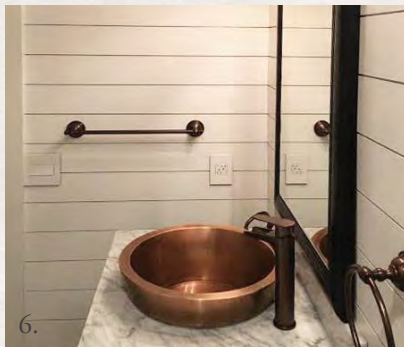

3. WAINSCOTING & DOOR COVER featuring WindsorONE Classical Craftsman Mouldings by Streamline Builders in CA
4. PORCH LID WITH BEAMS by Joe Denman Carpentry for Baker Barn & Restoration in PA **5. SHIPLAP CEILING WITH BEAMS**
 by Greg Bender Custom in TX **6. BATHROOM WALLS** by Woodsmith Construction LLC in NJ **7. ALONG AN ARCH** by Curry
 Construction in MD **8. VAULTED CEILING** by JL Madison General Contractors and Donahue Construction in CA **9. CEILING
 LID WITH SKYLIGHT DETAIL** by TS Inc. in CA **10. PORCH LID** by homeowner/builder Robert Gamen in CA **11. EXTERIOR
 SOFFIT DETAIL** by Holland Construction in CA

*Warranty based on proper installation, call 888.229.7900 or see WindsorONE.com/install for details

2 VERSATILE SHIPLAP PROFILES

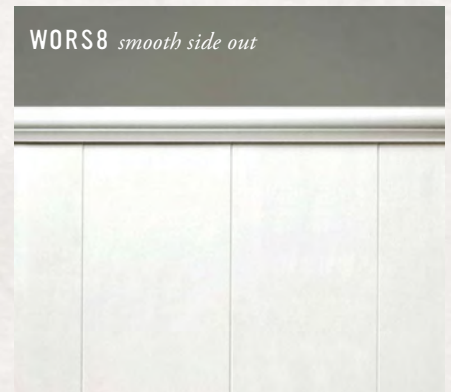

— VARIOUS TONGUE & GROOVE OPTIONS —

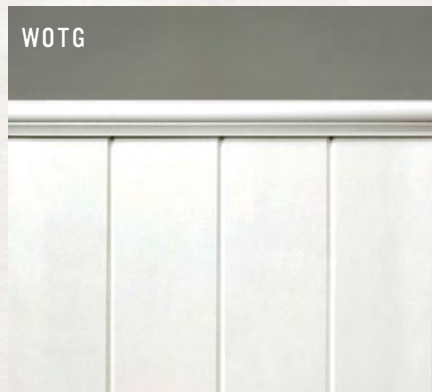

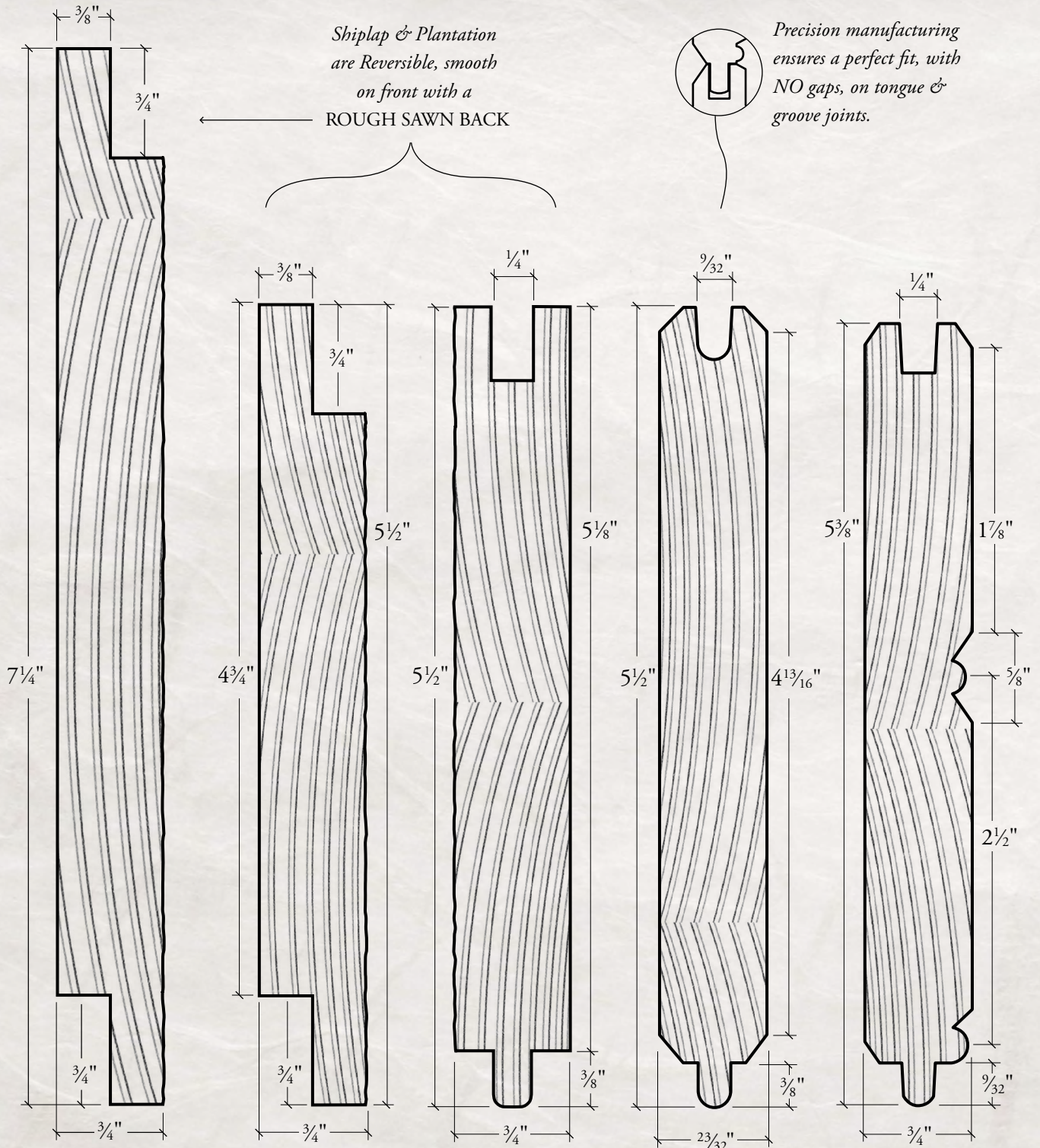

SPECIALTY BOARDS (AVAILABLE WITH WindsorONE+ PROTECTED 30yr WARRANTY)

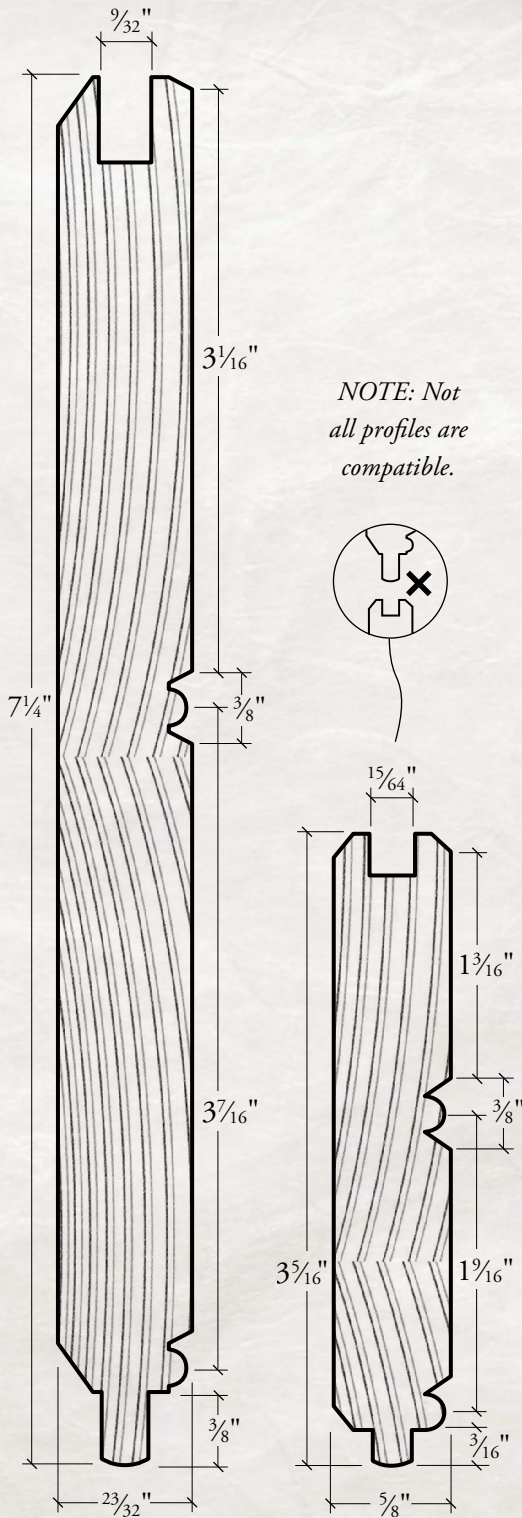

NOTE: Not all profiles are compatible.

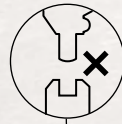

SPBC8
standard T&G
beadboard 16'

SPBC4
standard T&G
beadboard 16'

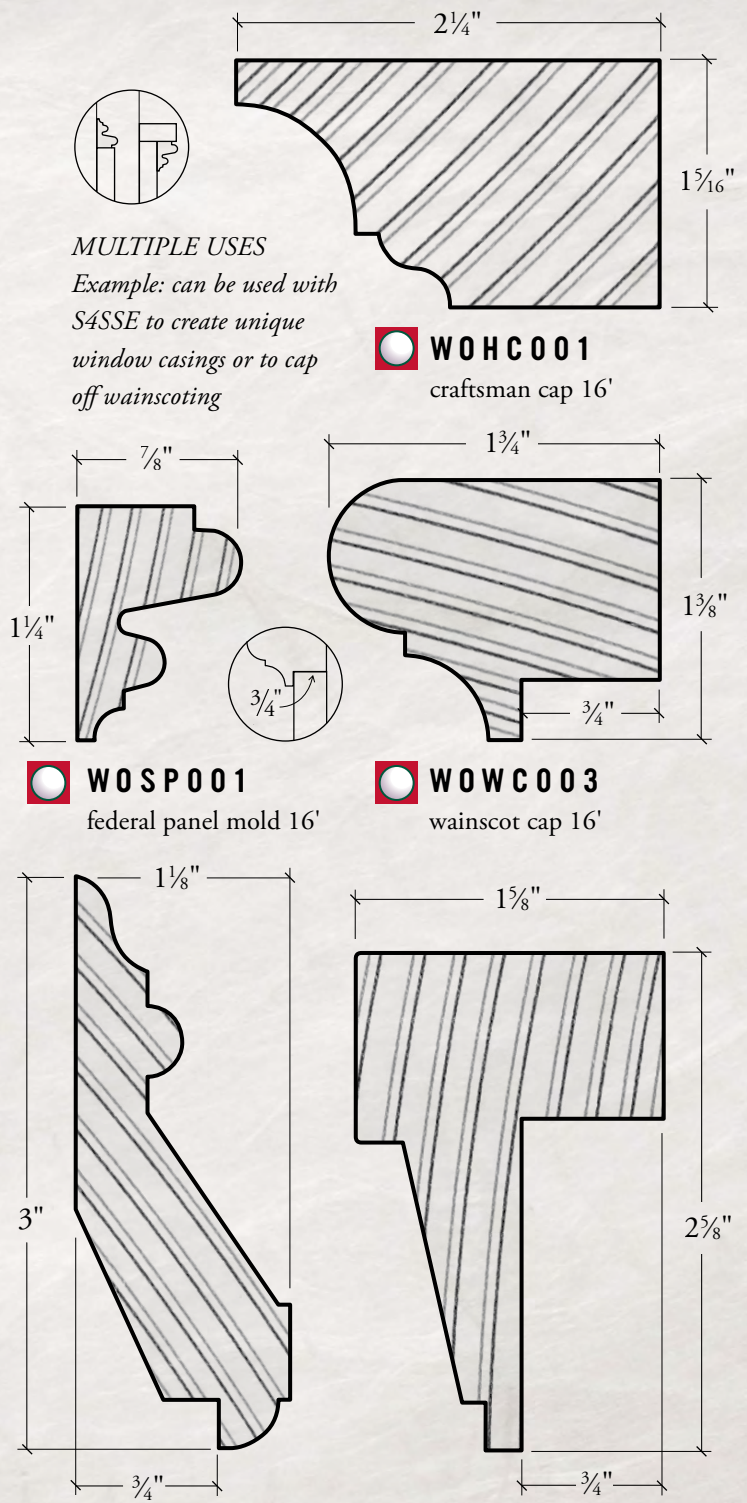

WOSPO01
federal panel mold 16'

WOWCO03
wainscot cap 16'

WOWCO02
wainscot cap 16'

WOWCO06
wainscot cap 16'

SPECIALTY BOARDS

CUSTOM ARCHES

& Architectural Accents

ARCH CASINGS

- Available in Primed MDF, PVC, most hardwood species
- 3/16" Reveal will be added to all supplied measurements & templates
- Reveal can be adjusted upon specification
- Most casings for Andersen units can be manufactured by Andersen unit number

ELLIPTICALS

SHOWN: ES1 EASTERN WHITE PINE



TEMPLATE REQUIRED

Measurement Required: A Measurement Only – Inside Width Jamb to Jamb

Elliptical units require a template of the jamb supplied on Red Rosin paper, Tyvek, or any flat surface durable paper (cardboard templates tend to lose the measurement accuracy required once folded). A measurement must be supplied with template to ensure accuracy of finished product.

EYEBROWS / ARCHES

SHOWN: GS419 IN AMERICAN CHERRY

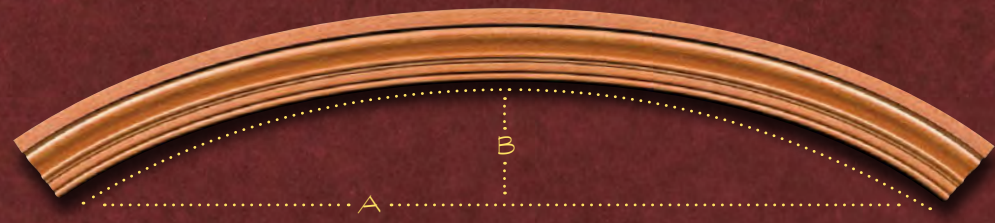

Measurements Required:

- A Measurement - Unit Width/Inside Jamb to Jamb
- B Measurement - Chord Height to Inside of Jamb

SCALE 1/2" = 1 FT.
DRAWN BY:
TRACED BY:
CHECKED BY:

HALF ROUNDS

SHOWN: PL458 PRIMED MDF

Measurements Required:

- A Measurement Only -
Inside Jamb To Jamb

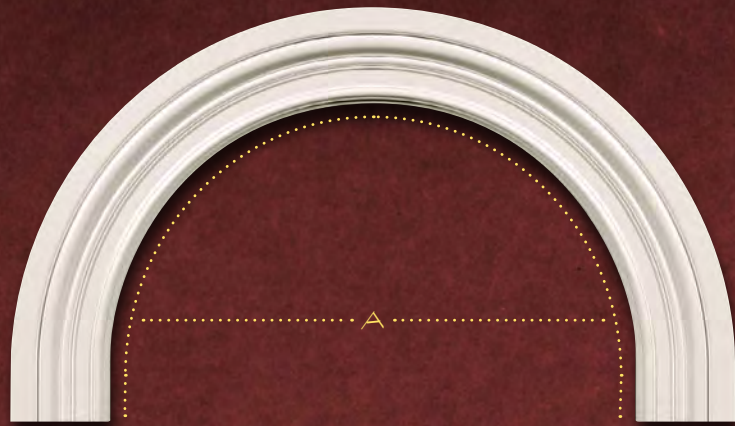

OVALS

SHOWN: ES1 IN PVC

Measurements Required:

- A Measurement - Unit Width
Inside Jamb to Jamb
- B Measurement - Unit Height
Inside Jamb to Jamb

TEMPLATE
REQUIRED

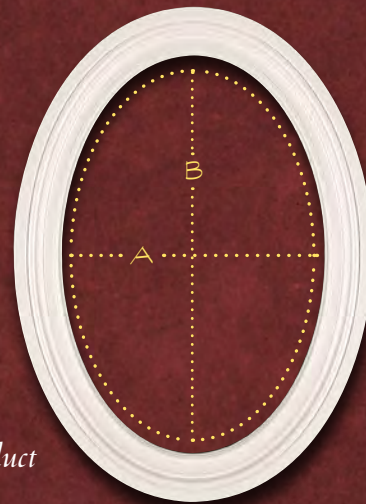

** All our milled PVC Arches will have a factory applied bonding primer to obtain a smooth finished product*

Oval units require a template of the jamb supplied on Red Rosin paper, Tyvek, or any flat surface durable paper (cardboard templates tend to lose the measurement accuracy required once folded). A and B measurements must be supplied with template to ensure accuracy of finished product.

FULL ROUNDS

SHOWN: 5/4 X 4 (1" X 3-1/2") PVC

Measurements Required:

- A Measurement Only -
Unit Width/Inside Jamb to Jamb (diameter)

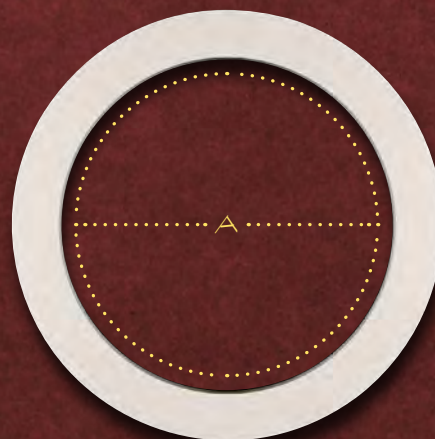

CUSTOM ARCHES

& Architectural Accents



HALF ROUND



ARCH/EYEBROW



ARCH/EYEBROW
WITH VERTICAL RETURN



ARCH/EYEBROW
WITH VERTICAL RETURNS
AND CAPITAL BANDS



ELLIPTICAL



ELLIPTICAL
WITH CAPITAL BANDS



PRE-FABRICATED ARCHED OPENINGS

- 1 CHOOSE ANY GARDEN STATE LUMBER CASING OR CUSTOM CASING
- 2 PICK YOUR ARCH STYLE
- 3 SELECT YOUR SPECIES (MDF, PVC, ANY HARDWOOD SPECIES)
- 4 SUPPLY US WITH YOUR OPENING DIMENSIONS AND JAMB WIDTH
- 5 FOLLOW INSTALLATION INSTRUCTIONS

OPTIONAL KEYS

Can Be Ordered Loose Or Applied

FLAT



FLAT W/CAP



ROUTED



ROUTED W/CAP



CUSTOM



- Available In MDF, PVC, Most Hardwood Species
- Made To Any Jamb Width
- Easy Installation

THE Hardwoods COLLECTION

INTRODUCING

Riverhead Building Supply's Quick Ship & Custom Run Hardwood Moulding Programs

QUICK SHIP PROGRAM:

- ✦ The profiles depicted on the following pages are available within 7 business days in the following hardwood species:
- ✦ Poplar ■ Red Oak ■ Maple
Cherry ■ Sapele (Mahogany)
- ✦ No minimum quantities required

CUSTOM RUN PROGRAM:

- ✦ **ALL Riverhead Building Supply Moulding Profiles** can be custom run in most hardwood and softwood species
- ✦ 10-14 Business day lead time
- ✦ No minimum quantities required
- ✦ Custom arches, half rounds, ellipticals, full rounds, and ovals are available

THE Hardwoods

COLLECTION

QUICK SHIP

Profiles are available within 7 business days

CROWNS



UC31H
3/4x3-3/4



UC41H
3/4x4-5/8



COV412H
1-1/16x4-1/2



CRW2H
11/16x2

L8010H
3/4x2-1/2

L8009H
11/16x3-1/2

8013H
11/16x4-1/2

8027H
11/16x5-1/4

ALL PROFILES
AVAILABLE IN



POPLAR



OAK



MAPLE



CHERRY



MAHOGANY



UC51H
13/16x5-5/8

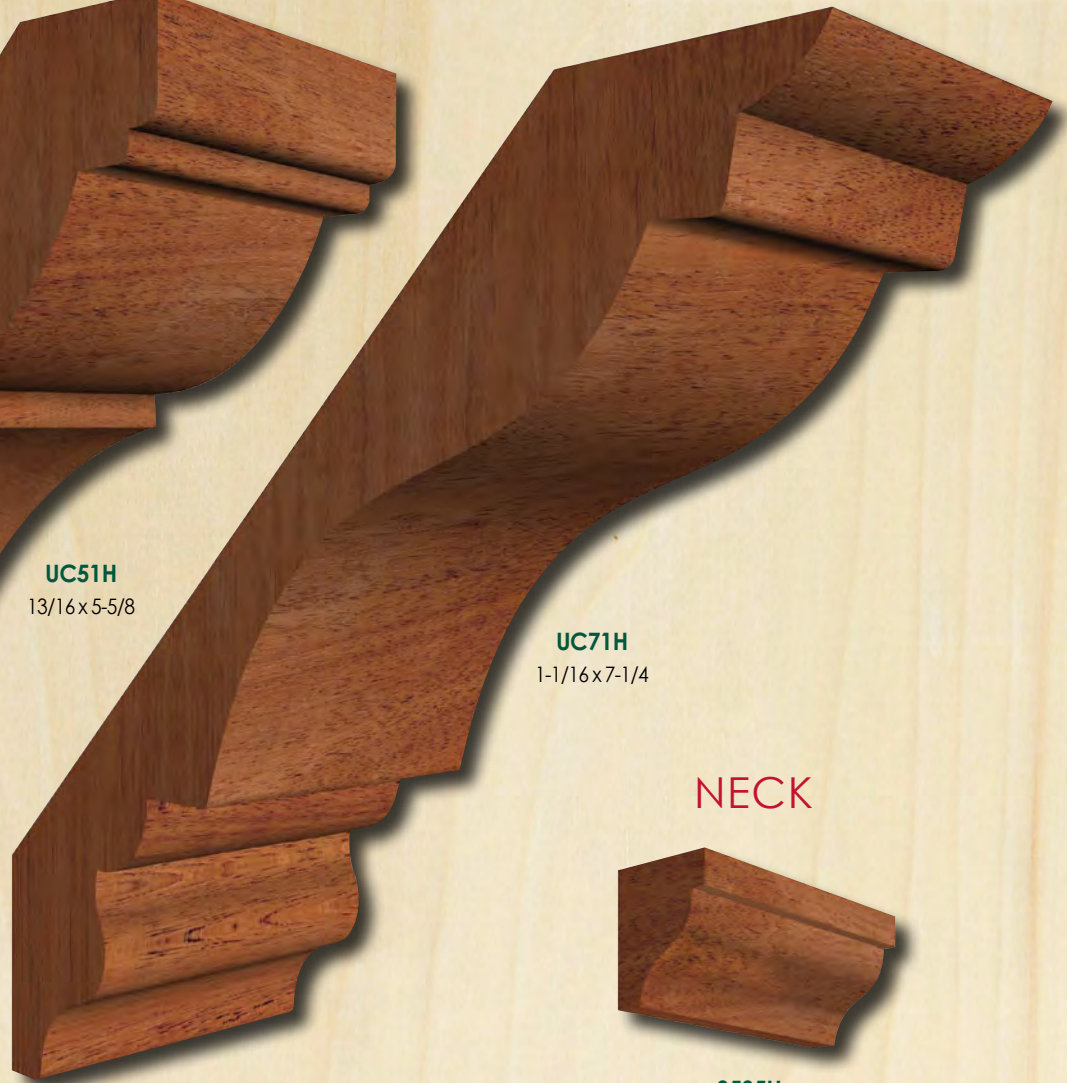

UC71H
1-1/16x7-1/4

NECK

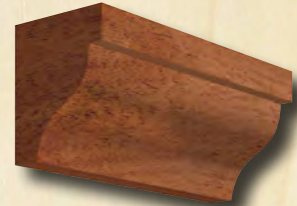

8535H
5/8x3/4

SOLID CROWNS



SC134H
3/4x1-3/4



SC214H
1-1/8x2-1/4



SC234H
1-3/8x2-3/4

All profiles are available in select hardwood species on a special order basis. Actual profiles may vary slightly from what is shown

THE Hardwoods

COLLECTION

QUICK SHIP

Profiles are available within 7 business days



BB5H
3/4x5

BB7H
3/4x7

BASES

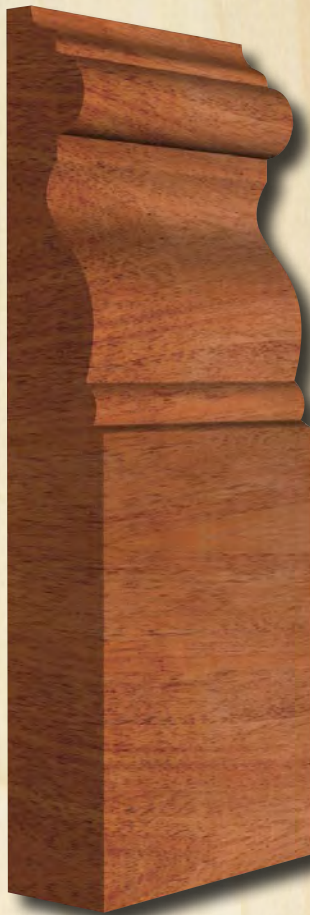

BB458H
11/16x4-5/8

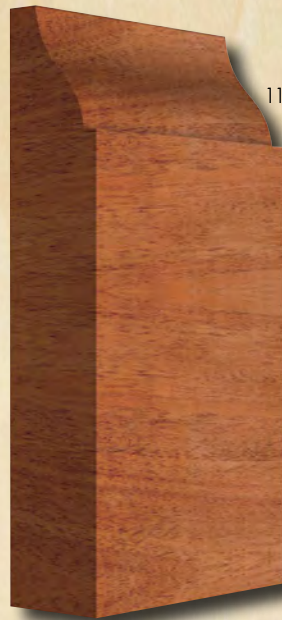

8712H
11/16x3-1/2

BASE CAPS

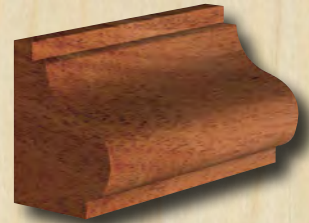

BC78H
11/16x7/8



WM164H
11/16x1-1/8

LWM163H
11/16x1-5/8



8412H
11/16x1-3/8



8416H
11/16x1-5/8

SHOE/FLOOR MOULDINGS



SH1H
1/2x1



SH78H
1/2x7/8



8423H
1/2x3/4



8422H
1/2x3/4

ALL PROFILES AVAILABLE IN



POPLAR



OAK



MAPLE



CHERRY



MAHOGANY

CASINGS



GS419H
 1-1/16x4-1/2



WC1H
 1-1/16x3-5/8



B8746H
 11/16x3-5/8



GS119H
 7/8x3-1/2



L8753H
 11/16x3-1/2



LWM445H
 13/16x3-3/8



8753H
 11/16x2-1/2



WM376H
 13/16x2-3/8

All profiles are available in select hardwood species on a special order basis. Actual profiles may vary slightly from what is shown

THE Hardwoods

COLLECTION

QUICK SHIP

Profiles are available within 7 business days

CHAIR RAILS



CR314H
3/4x3-1/4



ES7H
1-1/8x3-1/8



LWM297H
3/4x2-3/4

NOSE AND COVES

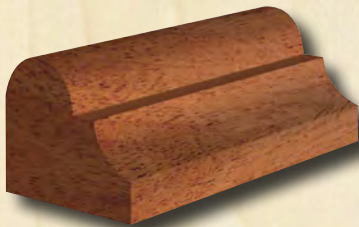

8575H **8577H** **8578H**
3/8x1/2 5/8x3/4 11/16x1-1/8

QUARTER ROUNDS

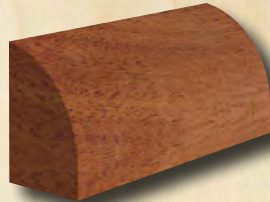

8063H **8065H**
1/2x1/2 3/4x3/4

COVES



WP101H **WM93H** **8024H** **CV278H**
1/2x1/2 3/4x3/4 9/16x1-5/8 13/16x2-7/8

HALF ROUNDS

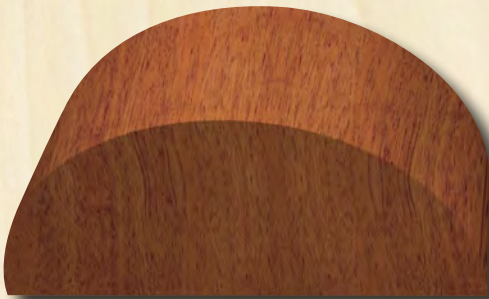

HR12H **HR34H** **HR1H** **HR15H** **HR2H** **HR3H**
1/4x1/2 3/8x3/4 1/2x1 3/4x1-1/2 1x2 1-1/2x3

FLAT STOOLS



FS312H **F1021H**
1x3-1/2 1x5-1/2

ALL PROFILES
AVAILABLE IN



POPLAR



OAK



MAPLE



CHERRY



MAHOGANY

PANEL MOULDINGS



LWM135H
 3/8x7/8



WM130H
 7/16x1-1/8

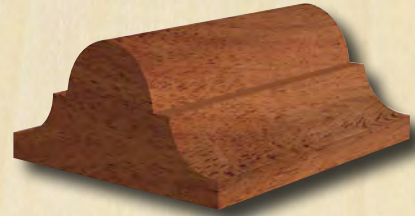

LWM133H
 3/4x1-1/2



PL2H
 11/16x2

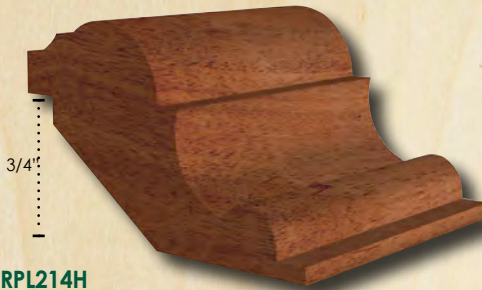

RPL214H
 13/16x2-1/4



RPL34H
 3/4x1-13/16



PLP312H
 1-3/16x3-1/2

STOP MOULDINGS



G8090H
 3/8x2-1/2



D8090H
 3/8" x 1-3/8

All profiles are available in select hardwood species on a special order basis. Actual profiles may vary slightly from what is shown

BEADED PANEL

& STRIP PRODUCTS

nantucket®
beadboard

Introducing our newest line of beaded panels and strip products. We have now expanded our line of primed MDF beadboard to include all of Nantucket Beadboard's product offerings and manufacturing capabilities.

- Broadened mix of on ground inventory
- Quick ship program for all non stock products
- Custom profile & pattern availability
- No minimum quantities

Stock items = 1-3 day lead time

Quick Ship items = 3 week lead time

Special Order items = 4 week lead time

GARDEN STATE LUMBER STOCK

IN STOCK FOR IMMEDIATE SHIPMENT

Standard Bead – 2" & 3" On Center

4' x 8' Sheet Shown at 15%



THICKNESS	MDF			MRI/NAF*	PVC
	4' x 8'	4' x 10'	4' x 12'	4' x 8'	4' x 8'
1/4"	14-SB2SB 14-SB3SB				
1/2"	SB2SB SB3SB	SB2SB-10 SB3SB-10	SB2SB-12 SB3SB-12	SB2SB-MRI SB3SB-MRI	SB2SB-PVC SB3SB-PVC

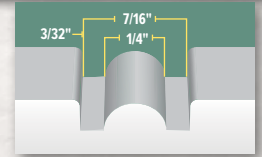

V-Bead – 1 5/8" & 2 1/2" On Center

4' x 8' Sheet Shown at 15%



THICKNESS	MDF			MRI/NAF*	PVC
	4' x 8'	4' x 10'	4' x 12'	4' x 8'	4' x 8'
1/4"	14-SB158VB 14-SB212VB				
1/2"	SB158VB SB212VB	SB158VB-10 SB212VB-10	SB158VB-12 SB212VB-12	SB158VB-MRI SB212VB-MRI	SB158VB-PVC SB212VB-PVC

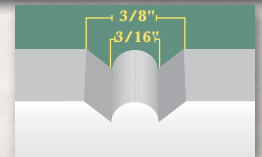

Modern Groove (1/4" x 1/4") – 6" On Center

4' x 8' Sheet Shown at 15%



THICKNESS	MDF			MRI/NAF*	PVC
	4' x 8'	4' x 10'	4' x 12'	4' x 8'	4' x 8'
1/2"	SB6MG	SB6MG-10	SB6MG-12		

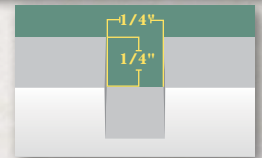

Nickel Gap (1/8" x 1/4") – 6" & 8" On Center

4' x 8' Sheet Shown at 15%

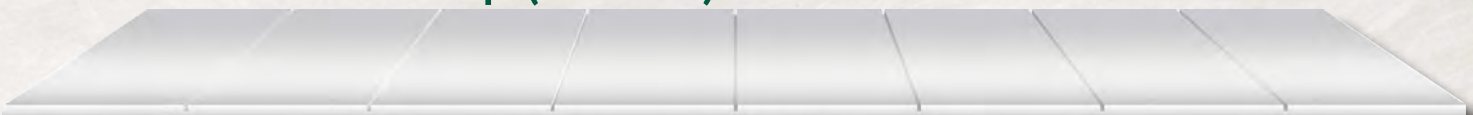

THICKNESS	MDF			MRI/NAF*	PVC
	4' x 8'	4' x 10'	4' x 12'	4' x 8'	4' x 8'
1/2"	SB6NK SB8NK	SB6NK-10 SB8NK-10	SB6NK-12 SB8NK-12		

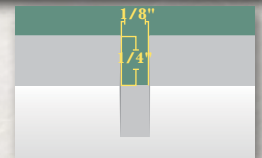

V-Groove – 6" On Center

4' x 8' Sheet Shown at 15%

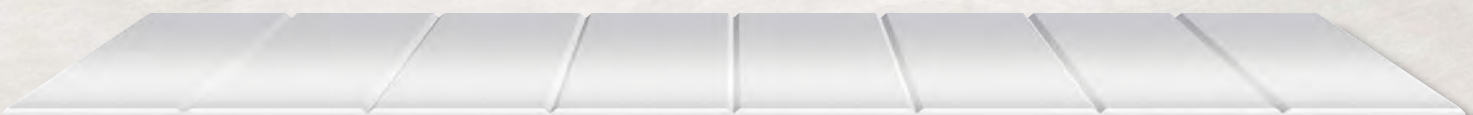

THICKNESS	MDF			MRI/NAF*	PVC
	4' x 8'	4' x 10'	4' x 12'	4' x 8'	4' x 8'
1/2"	SB6VG	SB6VG-10	SB6VG-12	SB6VG-MRI	SB6VG-PVC

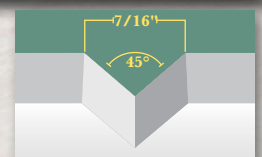

*MRI/NAF = Moisture Resistant & No Added Formaldehyde – Primed On Both Sides

All bead patterns can be **Special Ordered** to run the 4' length (up to 12' long).



- 1 MCOV8, MCC312, 1x8 S4S
- 2 MCC312, MCBB2
- 3 WC214
- 4 2-1/2 ON CENTER V-BEAD (1/4" THICK)
- 5 MCB7

All bead patterns can be **Special Ordered** to your desired distance on center.

QUICK SHIP+ SHEET PRODUCTS

3 WEEK LEAD TIME NO MINIMUM QUANTITIES

Standard Bead Quick Ship Items

AVAILABLE 2" AND 3" ON CENTER

4' x 8' Sheet Shown at 15%



THICKNESS	MDF	MRI/NAF	MRX	FR MDF	PVC
3/8"	4' x 8' 4' x 10' 4' x 12'				
1/2"	4' x 16'	4' x 10' 4' x 16'	4' x 8'	4' x 8'	4' x 8'

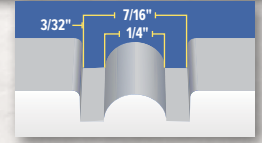

V-Bead Quick Ship Items

AVAILABLE 1 5/8" AND 2 1/2" ON CENTER

4' x 8' Sheet Shown at 15%



THICKNESS	MDF	MRI/NAF	MRX	FR MDF	PVC
3/8"	4' x 8' 4' x 10' 4' x 12'				
1/2"	4' x 16'	4' x 10' 4' x 16'	4' x 8'	4' x 8'	4' x 8'

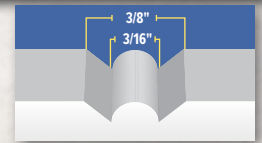

V-Groove Quick Ship Items

AVAILABLE 4", 6" AND 8" ON CENTER

4' x 8' Sheet Shown at 15%



THICKNESS	MDF	MRI/NAF	MRX	FR MDF	PVC
1/2"	4' x 8' 4' x 10' 4' x 12' 4' x 16'	4' x 8' 4' x 10' 4' x 16'	4' x 8'	4' x 8'	4' x 8'

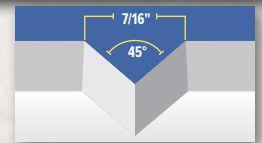

MRI = MOISTURE RESISTANT / NO ADDED FORMALDEHYDE ■ MRX = EXTERIOR MDF ■ FR= FIRE RATED (CLASS A)



1

2

3

- 1 **8" ON CENTER V-GROOVE**
- 2 **LK4**
- 3 **FS312 STOOL, LK3 APRON**

All bead patterns can be **Special Ordered** to run the 4' length (up to 12' long).

QUICK SHIP+ SHEET PRODUCTS

3 WEEK LEAD TIME

Modern Grooves & Nickel Gap

AVAILABLE 4", 6" AND 8" ON CENTER

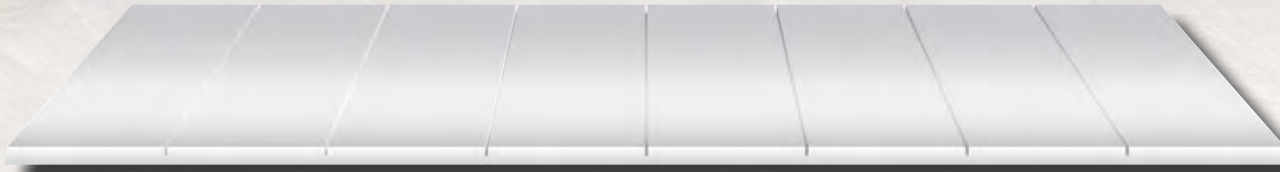

1/8" x 1/8" Nickel Gap

4' x 8' Sheet Shown at 15%

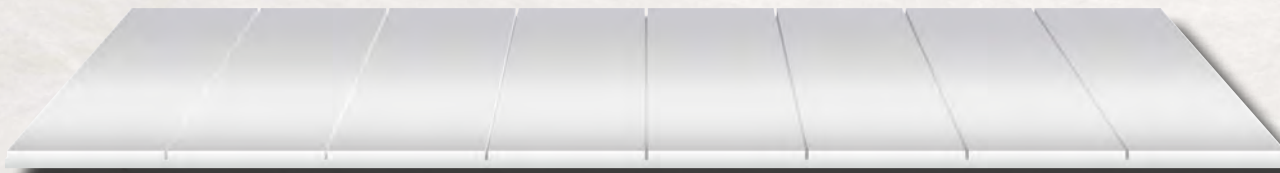
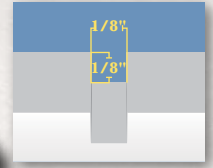

1/8" x 1/4" Nickel Gap

4' x 8' Sheet Shown at 15%

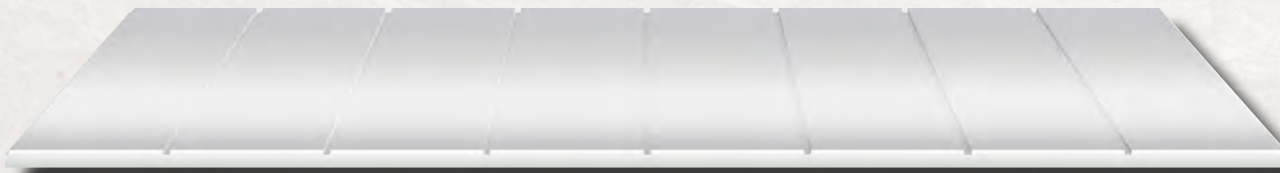
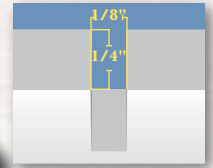

1/4" x 1/8" Modern Groove

4' x 8' Sheet Shown at 15%

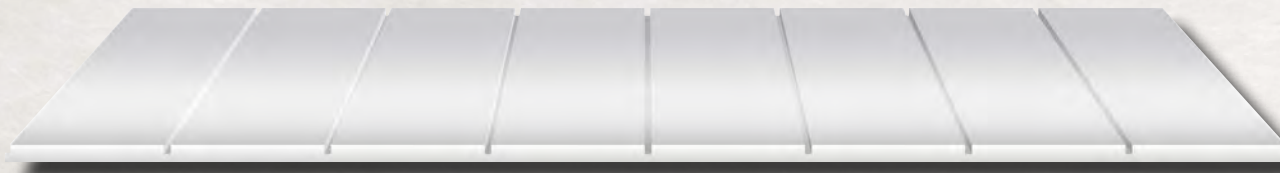
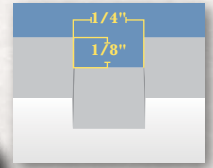

1/4" x 1/4" Modern Groove

4' x 8' Sheet Shown at 15%

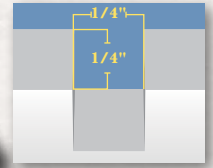

THICKNESS	MDF	MRI/NAF	MRX	FR MDF	PVC
1/4"	8'*				
3/8"	4' x 8' 4' x 10' 4' x 12'*				
1/2"	4' x 8' 4' x 10' 4' x 12' 4' x 16'	4' x 8' 4' x 10' 4' x 16'	4' x 8'	4' x 8'	4' x 8'

*Only Available In 1/4" x 1/8" & 1/8" x 1/8"

MRI = MOISTURE RESISTANT / NO ADDED FORMALDEHYDE ■ MRX = EXTERIOR MDF ■ FR = FIRE RATED (CLASS A)



1

- 1 1/4" x 1/4" MODERN GROOVE (4" ON CENTER)
- 2 GSB725
- 3 LK4

- 1 1/8" x 1/4" MODERN GROOVE (4" ON CENTER)
- 2 1x4, SC214, FS312

1

2

All bead patterns can be **Special Ordered** to your desired distance on center.



1

2

3

4

5

- 1 **1/4" x 1/4" MODERN GROOVE (4" ON CENTER)**
- 2 **1x6, 1x3, MSC275**
- 3 **MCR750**
- 4 **MCB512**
- 5 **1/4" x 1/4" MODERN GROOVE (8" ON CENTER)**

All bead patterns can be **Special Ordered** to run the 4' length (up to 12' long).



- 1 **1/4" x 1/4" MODERN GROOVE (8" ON CENTER)**
- 2 **COV312**
- 3 **ES12**
- 4 **1/4" x 1/4" MODERN GROOVE (4" ON CENTER)**
- 5 **1/4" x 1/4" MODERN GROOVE (4" ON CENTER)**
- 6 **BB7**

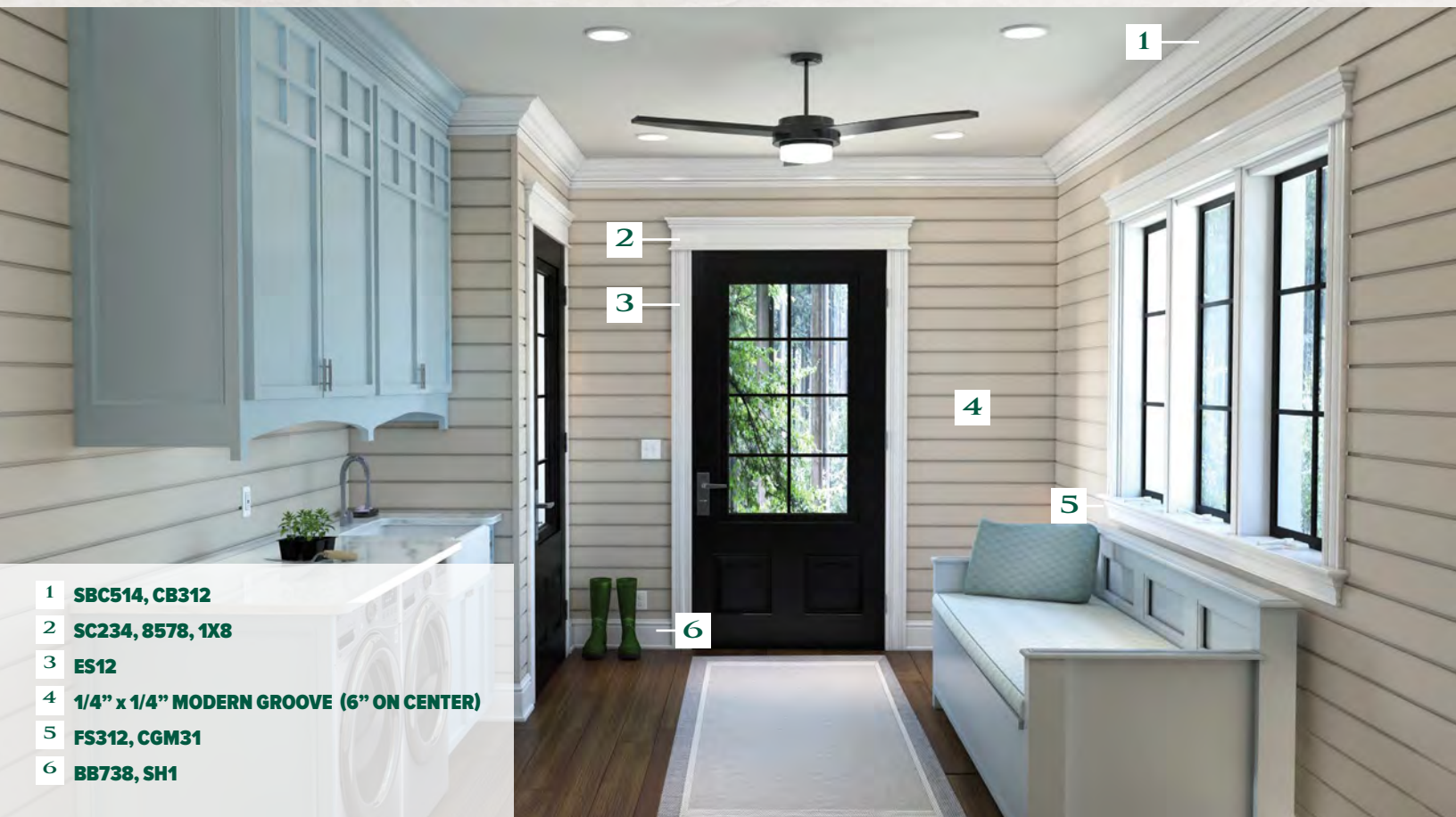

- 1 **SBC514, CB312**
- 2 **SC234, 8578, 1X8**
- 3 **ES12**
- 4 **1/4" x 1/4" MODERN GROOVE (6" ON CENTER)**
- 5 **FS312, CGM31**
- 6 **BB738, SH1**

All bead patterns can be **Special Ordered** to your desired distance on center.

QUICK SHIP+ SHEET PRODUCTS

3 WEEK LEAD TIME

Random VG-1 & Random VG-2



Random VG-1

4' x 8' Sheet Shown at 15%



Random VG-2

4' x 8' Sheet Shown at 15%

THICKNESS	MDF	MRI/NAF	MRX	FR MDF	PVC
1/2"	4' x 8' 4' x 10' 4' x 12' 4' x 16'	4' x 8' 4' x 10' 4' x 16'	4' x 8'	4' x 8'	4' x 8'

Most patterns depicted in this catalogue can be special ordered to the Random 1 and Random 2 configurations.

Random 1: 3½", 5½", 5½", 7½", 5½", 3½", 7½", 4½", 5 = 48"

Random 2: 4", 6", 8", 4", 6", 8", 4", 8" = 48"

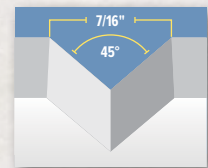

Mini V-Groove & Mini Mini V-Groove

AVAILABLE 4", 6" AND 8" ON CENTER

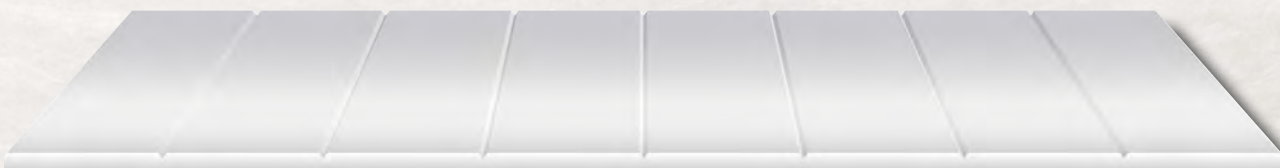

Mini V-Groove

4' x 8' Sheet Shown at 15%

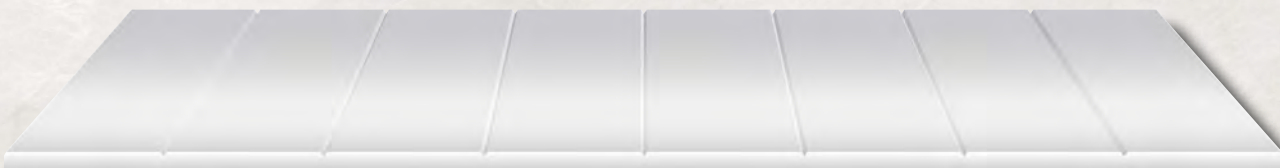
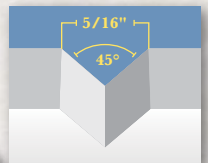

Mini Mini V-Groove

4' x 8' Sheet Shown at 15%

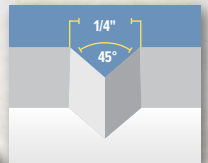

THICKNESS	MDF	MRI/NAF	MRX	FR MDF	PVC
1/4"	8' (Mini Mini V-Groove Only)				
3/8"	4' x 8' 4' x 10' 4' x 12'				
1/2"	4' x 8' 4' x 10' 4' x 12' 4' x 16'	4' x 8' 4' x 10' 4' x 16'	4' x 8'	4' x 8'	4' x 8'

MRI = MOISTURE RESISTANT / NO ADDED FORMALDEHYDE ■ MRX = EXTERIOR MDF ■ FR = FIRE RATED (CLASS A)

All bead patterns can be **Special Ordered** to run the 4' length (up to 12' long).

SHIPLAP STRIP PRODUCTS

3 WEEK LEAD TIME

Outstanding for Ceiling Applications

Another elegant solution we offer from Nantucket BeadBoard is their shiplap strip products. These easy to install strips dramatically increase your building options by giving you another dimension in beadboard.

- **Ideal For Ceiling Applications**
- **Easy To Handle**
- **Dramatically Decreases Your Install Time**
- **Short Lead Time Of 3 Weeks**

Standard Bead

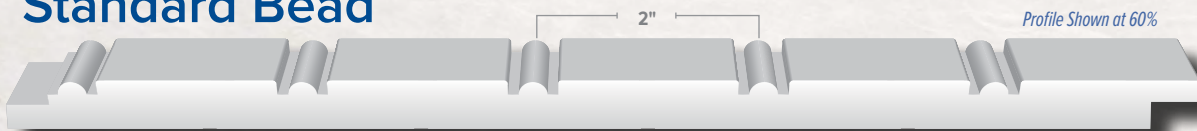

2" STANDARD BEAD (10" FACE) 1 LINEAL FT = .83 SQ FT – ORDER IN 4 PIECE INCREMENTS

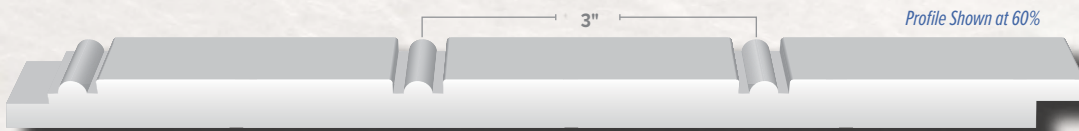

3" STANDARD BEAD (9" FACE) 1 LINEAL FT = .75 SQ FT – ORDER IN 5 PIECE INCREMENTS

V-Bead

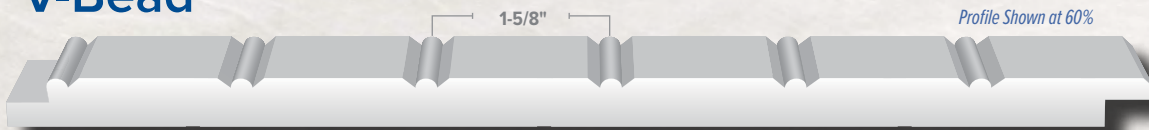

1-5/8" V-BEAD (9.6" FACE) 1 LINEAL FT = .80 SQ FT – ORDER IN 4 PIECE INCREMENTS

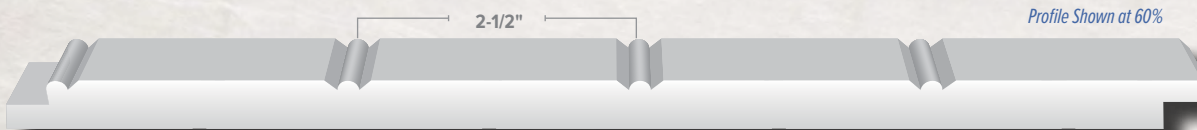

2-1/2" V-BEAD (10.104" FACE) 1 LINEAL FT = .842 SQ FT – ORDER IN 4 PIECE INCREMENTS

V-Groove



5-1/2" V-GROOVE (11" FACE) 1 LINEAL FT = .917 SQ FT – ORDER IN 4 PIECE INCREMENTS

All Shiplap Products are Quick Ship

THICKNESS	MDF	MRI/NAF	MRX	FR MDF
1/2"	8' 10' 12' 16'	8' 10' 16'	8'	8'

MRI = MOISTURE RESISTANT / NO ADDED FORMALDEHYDE ■ MRX = EXTERIOR MDF ■ FR= FIRE RATED (CLASS A)

All bead patterns can be **Special Ordered** to your desired distance on center.



- 1 1/4" x 1/4" MODERN GROOVE (10" ON CENTER)
- 2 UC51, BB6
- 3 ECBCAP, BDB45
- 4 ECBCAP, 1x6
- 5 STANDARD BEAD 3" ON CENTER
- 6 LS6
- 7 BB7, 1X8, SH1



- 1 MCOV6, MCC312, MCS1
- 2 MC312, MCBB1
- 3 5/4" x 6" S4S, MSC275, MCS1
- 4 MCAP2, 1" x 4" S4S, 2-1/2"
- 5 V-BEAD PANELING

All bead patterns can be **Special Ordered** to run the 4' length (up to 12' long).



- 1 **8" MODERN SHIPLAP STRIP**
- 2 **PLC634**
- 3 **ECBCAP**
- 4 **4" MODERN SHIPLAP STRIP**
- 5 **5/4 x 6**

All bead patterns can be **Special Ordered** to your desired distance on center.

SHIPLAP STRIP PRODUCTS

3 WEEK LEAD TIME

Modern Shiplap Strip

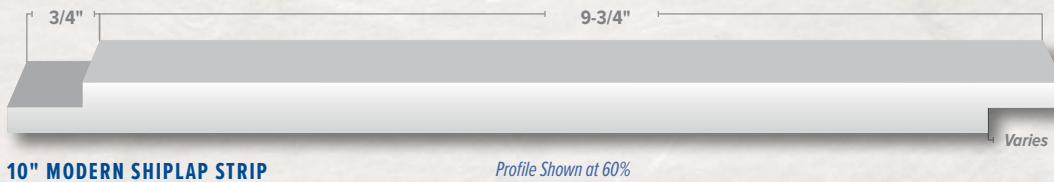
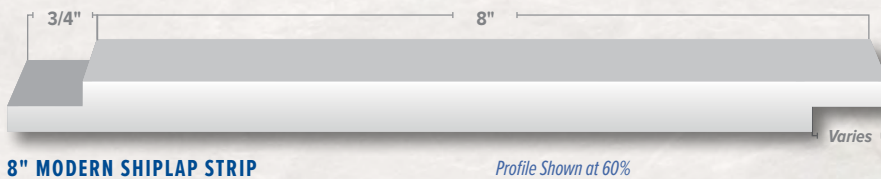
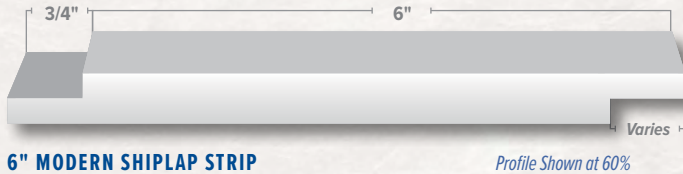

Specify your desired fit:

- Flush Fit
- 1/8" Groove
- 1/4" Groove

See details below

Flush Fit Detail

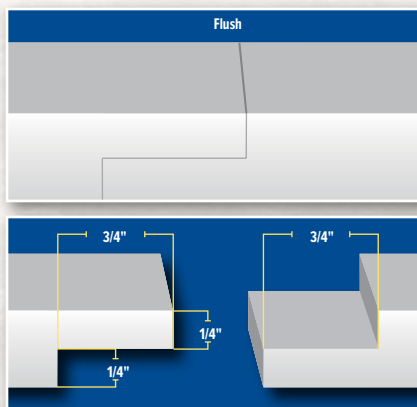

1/8" Groove Detail

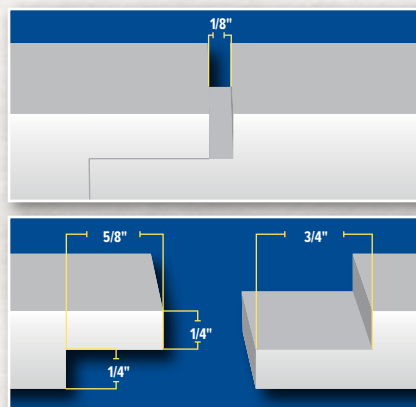

1/4" Groove Detail

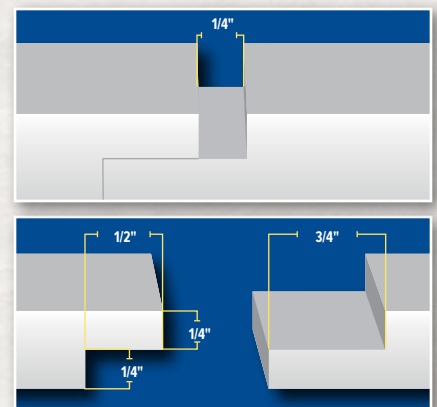

All Shiplap Products are Quick Ship

THICKNESS	MDF	MRI/NAF	MRX	FR MDF
1/2"	12' 16'	8' 10' 16'	8'	8'

MRI = MOISTURE RESISTANT / NO ADDED FORMALDEHYDE ■ MRX = EXTERIOR MDF ■ FR= FIRE RATED (CLASS A)

All bead patterns can be **Special Ordered** to run the 4' length (up to 12' long).

SPECIAL ORDER SHEET PRODUCTS

4 WEEK LEAD TIME

Manufactured To Your Specified Distance On Center

If you are looking for something both unique and highly customizable, our special order products offer a wide variety of options.

- **Unique Selection Of Styles**
- **Beads Run In Either 4' Or 8' Direction**
- **Manufactured To Your Desired Distance On Center**
- **No Minimum Quantities**
- **Short Lead Times Of 4 Weeks**



Large V-Bead

4' x 8' Sheet Shown at 15%

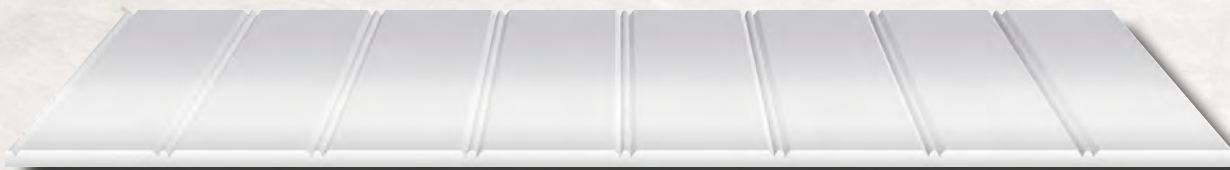
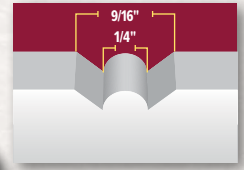

Jumbo V-Bead

4' x 8' Sheet Shown at 15%

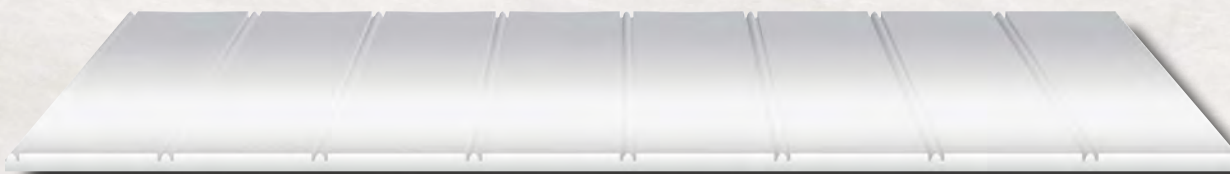
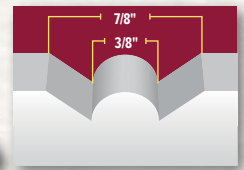

Large Standard Bead

4' x 8' Sheet Shown at 15%

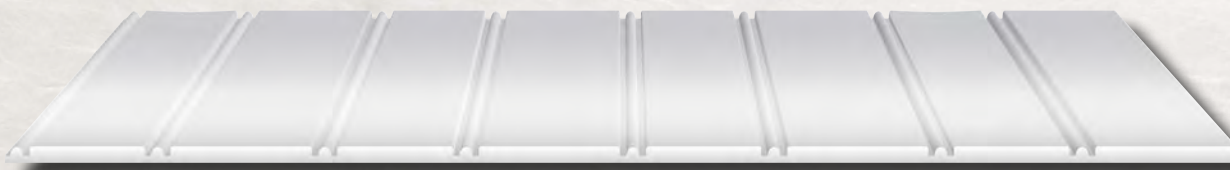
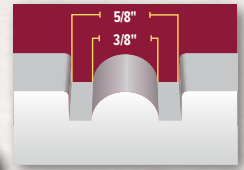

Jumbo Standard Bead

4' x 8' Sheet Shown at 15%

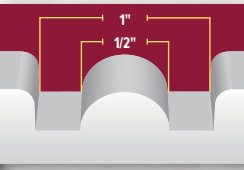

THICKNESS	MDF	MRI/NAF	MRX	FR MDF	PVC
1/2"	4' x 8' 4' x 10' 4' x 12'	4' x 8' 4' x 10'	4' x 8'	4' x 8'	4' x 8'

MRI = MOISTURE RESISTANT / NO ADDED FORMALDEHYDE ■ MRX = EXTERIOR MDF ■ FR= FIRE RATED (CLASS A)



All bead patterns can be **Special Ordered** to your desired distance on center.



- 1 **8" MODERN SHIPLAP STRIP**
- 2 **PLC634**
- 3 **LARGE CENTER BEAD (3" ON CENTER)**
- 4 **ES13, ES3**
- 5 **LS6**
- 6 **ES9**
- 7 **BB7**

All bead patterns can be **Special Ordered** to run the 4' length (up to 12' long).

SPECIAL ORDER SHEET PRODUCTS

4 WEEK LEAD TIME

Manufactured To Your Specified Distance On Center

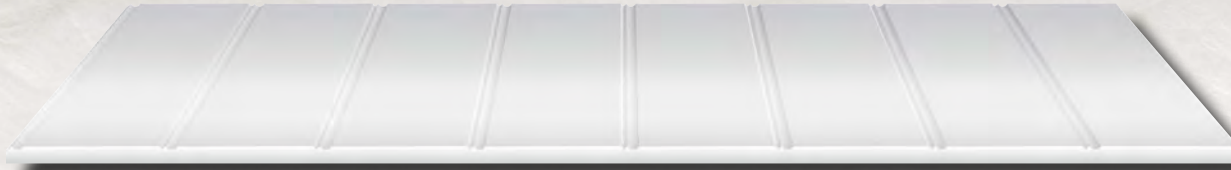

Cove Bead

4' x 8' Sheet Shown at 15%

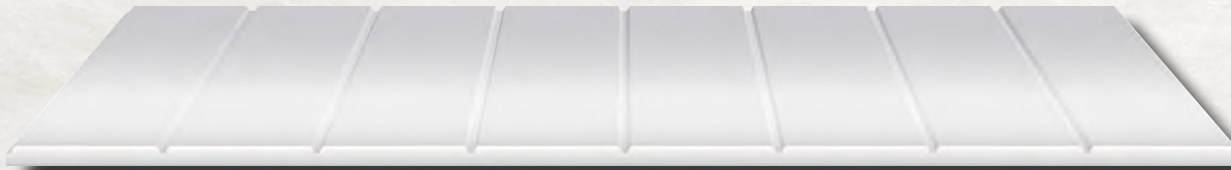
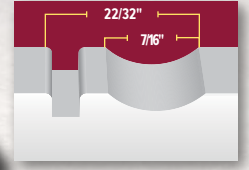

V-Channel

4' x 8' Sheet Shown at 15%

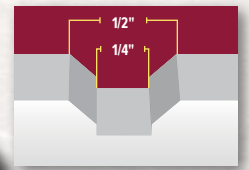

Butterfly

4' x 8' Sheet Shown at 15%

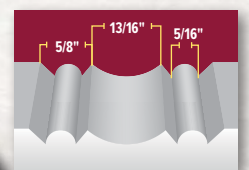

Large Butterfly

4' x 8' Sheet Shown at 15%

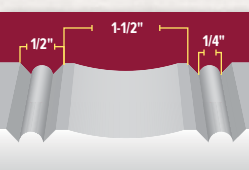

THICKNESS	MDF	MRI/NAF	MRX	FR MDF	PVC
1/2"	4' x 8' 4' x 10' 4' x 12'	4' x 8' 4' x 10'	4' x 8'	4' x 8'	4' x 8'

MRI = MOISTURE RESISTANT / NO ADDED FORMALDEHYDE ■ MRX = EXTERIOR MDF ■ FR= FIRE RATED (CLASS A)

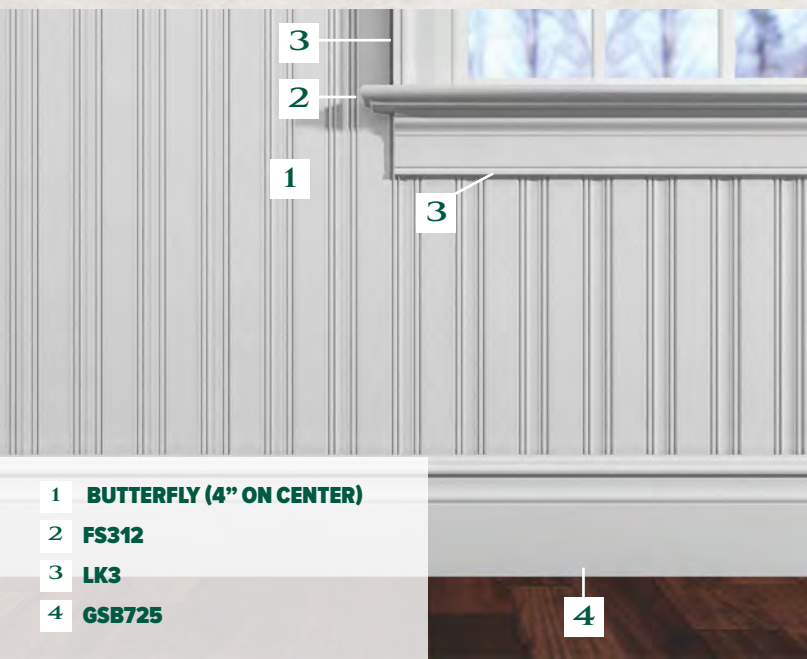

- 1 BUTTERFLY (4" ON CENTER)
- 2 FS312
- 3 LK3
- 4 GSB725

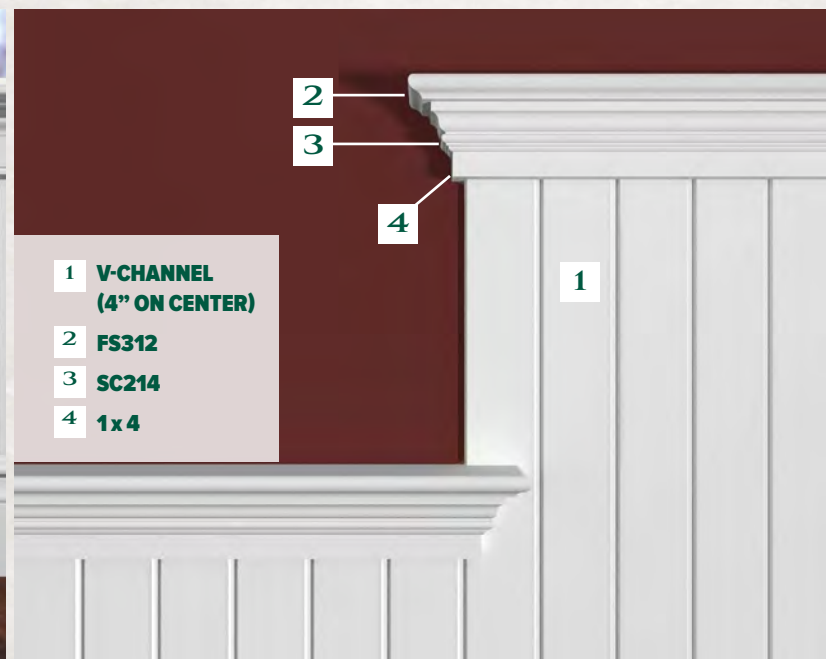

- 1 V-CHANNEL (4" ON CENTER)
- 2 FS312
- 3 SC214
- 4 1x4

All bead patterns can be **Special Ordered** to your desired distance on center.

NOW STOCKING

MELAMINE SHEETS & SHELVING

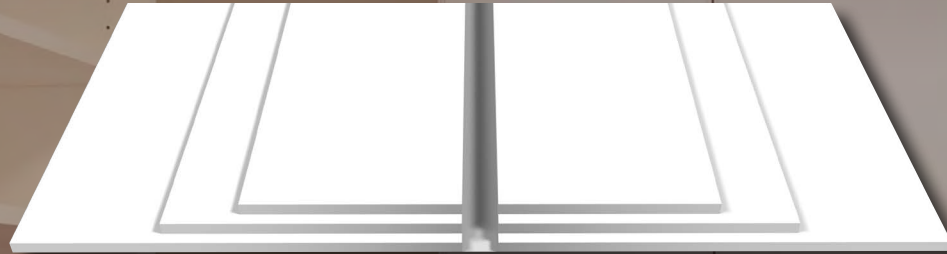

SHELVING

Edge Banded One Long Edge

3/4 X 12" (11-1/2") 8' AND 12' LENGTHS (34MEL12-8) (34MEL12-12)
3/4 X 16" (15-1/2") 8' AND 12' LENGTHS (34MEL16-8) (34MEL16-12)
3/4 X 24" (23-1/2") 8' AND 12' LENGTHS (34MEL24-8) (34MEL24-12)

PRE-DRILLED

3/4 X 16" (15-1/2") X 8' LENGTHS (34MEL16-8PD)

**SHELVING IS SQUARE EDGED

PRE-DRILLED SHELVING SPEC
HOLE DIAMETER IS 3/16"

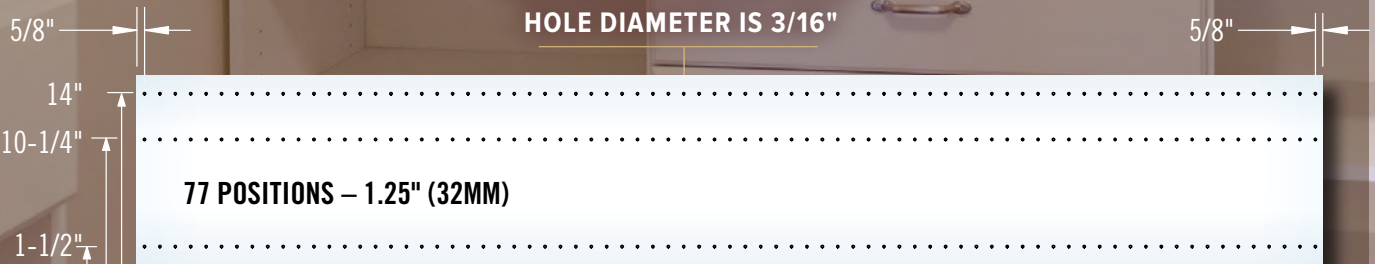

SHEETS

3/4 X 4 X 8 (49" X 97" WHITE 2 FACE) (34MEL4X8)

- Please call for pricing -

All bead patterns can be **Special Ordered** to run the 4' length (up to 12' long).

EDGE & CENTER BEADS

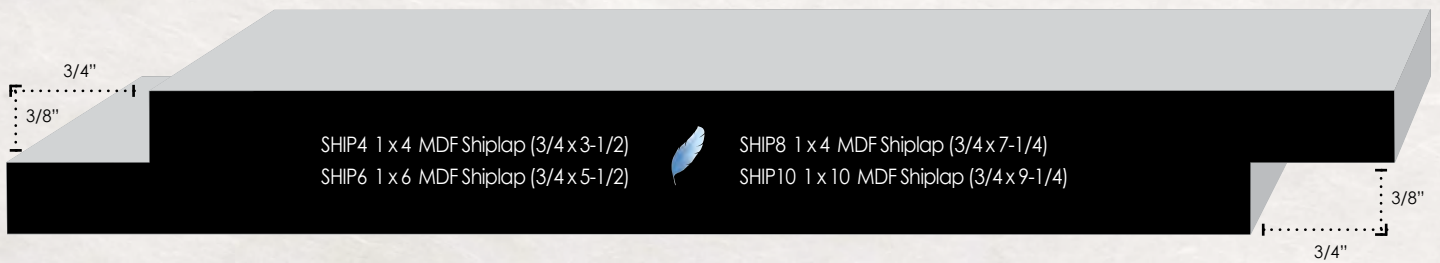
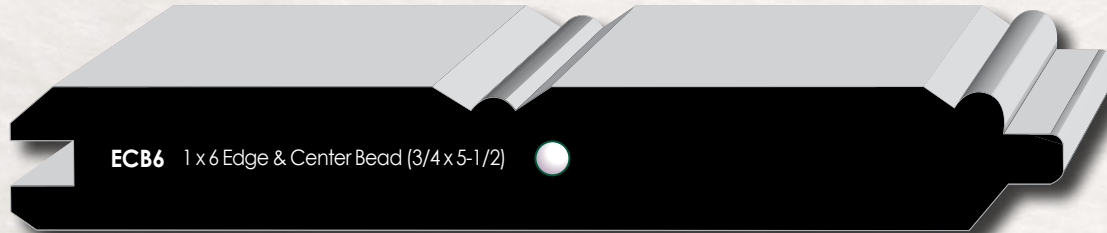
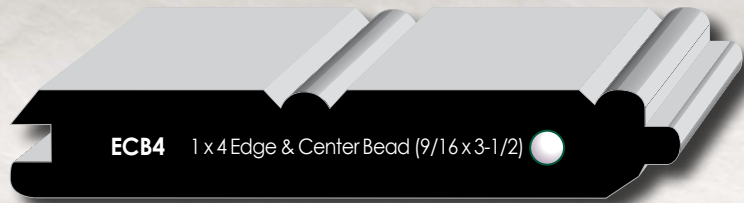

BBCAP12, ECB4, BC5 Crown, SAN525 Base

All profiles are available in select hardwood species on a special order basis. Actual profiles may vary slightly from what is shown.



ULTRALITE MDF S4S STOCK

PRIMED ULTRALITE MDF PRIMED 4 SIDES, 16' LENGTHS

NOMINAL SIZE	ACTUAL SIZE	SKU
1" x 4"	3/4" x 3-1/2"	D14
1" x 6"	3/4" x 5-1/2"	D16
1" x 8"	3/4" x 7-1/4"	D18
1" x 10"	3/4" x 9-1/4"	D110
1" x 12"	3/4" x 11-1/4"	D112

ULTRALITE MDF SHEET STOCK

THICKNESS	SHEET SIZE	SKU
1/8"	4' x 8'	18MDF
1/4"	4' x 8'	14MDF
3/8"	4' x 8'	38MDF
1/2"	4' x 8'	12MDF in stock
1/2"	4' x 10'	12MDF10
1/2"	4' x 12'	12MDF12
5/8"	4' x 8'	58MDF
3/4"	4' x 8'	34MDF in stock
3/4"	4' x 10'	34MDF10
3/4"	4' x 12'	34MDF12
3/4"	4' x 16'	34MDF16
1"	4' x 8'	1MDF
1-1/4"	4' x 8'	54MDF
1-1/2"	4' x 8'	64MDF

TRŪSTILE[®]

A MARVIN[®] BRAND



1-800-378-3650 • rbscorp.com



3M122022NY