



UPSTATE DOOR[®]

FINE DOOR SOLUTIONS... ONE SOURCE



Upstate Door specializes in distinctive, one-of-a-kind doors.

We make the complicated simple. We can easily accommodate unusual or unique sizes and shapes, making us a perfect partner for distinctive projects. Our staff of drafters, engineers, craftsmen, and customer representatives streamline the ordering process for you, and are here from the start of the proposal all the way to installation day!

Accompanying an industry-leading product with personalized service, Upstate Door is able to take your vision and make it a reality.

THE UPSTATE DIFFERENCE

Looking for something unique or different? We can create exactly what you're looking for: custom doors, made-to-order to your specifications. Contact our door experts to get started!





WHAT STYLES DO WE OFFER?

| | | |
|----------------|-----------------|----------------|
| Interior | Fire Rated | Art Deco |
| Exterior | Flush | Colonial |
| Screen/Storm | French | Contemporary |
| MDF | Impact Rated | Craftsman |
| Barn | Louver | French Country |
| Bifold | Oversized | Historical |
| Bypass | Pivot | Modern |
| Carriage | Plank | Traditional |
| Clipped Corner | Pocket | Tudor |
| Coastal | Slide | Victorian |
| Dutch | Tongue & Groove | And More! |



All of Upstate Door's products are engineered and handcrafted in the USA between our two facilities in Western New York.



For questions, please call our door experts at 800-570-8283



THE UPSTATE DOOR PROCESS



Talk With Our Experts

Together, we will discuss the design and specifications to ensure your satisfaction.

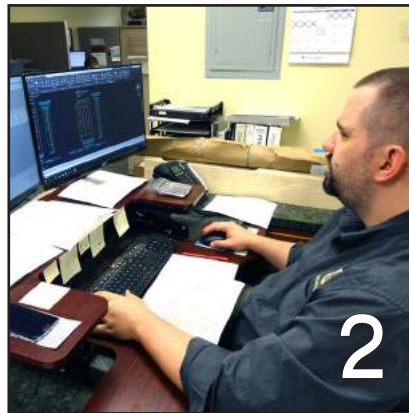

Receive a Proposal

Our team will take your specifications and create a proposal.

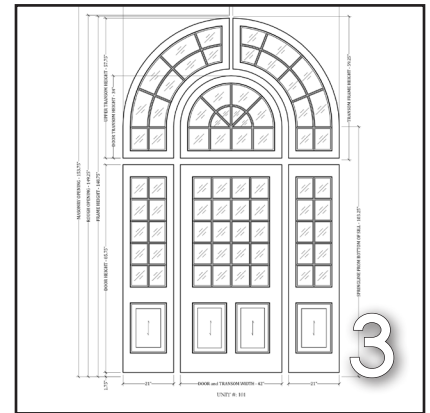

Design Approval

We will seek your approval that the design and technical drawings meet your needs.



Door Production

Our master craftsmen carefully construct and create your door.



Factory Finishing

All six sides of the door can be finished in the factory before being shipped.



Shipping

The doors are shipped to you on our trucks to ensure safe arrival.

TABLE OF CONTENTS

We blend old-world craftsmanship with state-of-the-art technology to produce unique, custom interior and exterior doors. When you choose Upstate Door, you know you will receive a beautiful handcrafted work of art that fits your needs and is completely personalized to your style.

CHOOSE A PRODUCT

| | |
|---|-----|
| Distinctive Solutions vs. Classic Solutions | 6-7 |
|---|-----|

PERSONALIZE YOUR DOOR

| | |
|----------------------------------|-------|
| Wood Species Options | 10-11 |
| MDF vs Wood | 12 |
| MDF Options..... | 13 |
| Sticking Options | 14 |
| Panel Options | 15 |
| SDL + TDL Options..... | 16 |
| Molding Options | 16 |
| Glass Options..... | 18 |
| Wrought Iron Options | 19 |
| Frame Options | 20 |
| Door Stop Options | 20 |
| Casing Options | 20 |
| Sill Options..... | 21 |
| Weatherstripping Options..... | 21 |
| Door Bottom Options..... | 21 |
| Drip Cap + Astragal Options..... | 21 |

HARDWARE OPTIONS

| | |
|----------------------------|----|
| Hinge Options | 24 |
| Hinge Finishes | 25 |
| Multipoint Hardware | 26 |
| Double Door Hardware | 27 |

CONSTRUCTION

| | |
|--------------------------|----|
| Door Construction..... | 28 |
| Panel Construction..... | 29 |
| Stile Construction | 31 |
| CNC Machining..... | 32 |
| Decorative Options | 33 |

LAYOUTS

| | |
|------------------------|-------|
| Door Layouts | 34-50 |
| Sidelite Layouts | 51 |
| Transom Layouts..... | 52 |

SPECIALTY APPLICATIONS

| | |
|--|-------|
| Flush Doors | 54-55 |
| Pivot Doors..... | 56 |
| Oversized Doors (Carriage + Barn)..... | 58-59 |
| Screen/Storm Doors | 60-61 |
| Coastal Doors | 62-63 |
| Impact Rated Doors..... | 64 |
| Fire Rated Doors..... | 65 |
| Bifold Doors | 66 |
| Sliding Doors | 67 |
| Louver Doors | 68 |
| Dutch Doors..... | 69 |
| Clipped Corner + Pocket Doors..... | 70 |
| Miracle Doors | 71 |
| Historical Replications | 72 |
| Commercial Doors..... | 73 |

FINE FINISHING SOLUTIONS

| | |
|-------------------------------|-------|
| Fine Finishing Solutions..... | 76-77 |
|-------------------------------|-------|

WARRANTY INFORMATION

| | |
|---------------------------------|-------|
| Paint/Stain Warranty Chart..... | 78 |
| Warranty | 80-81 |
| Use + Care Guide..... | 82 |

BUILDER + ARCHITECTS

| | |
|-------------------------------------|----|
| Architect + Builder Advantages..... | 83 |
| Mobile Showroom..... | 83 |



Architectural

DISTINCTIVE SOLUTIONS VS. CLASSIC SOLUTIONS

Upstate Door offers two different product lines: Distinctive Door Solutions and Classic Door Solutions.

Each line is comprised of hand-crafted, unique fine wood and MDF doors. Each door is constructed the same way with the same high-quality materials, even though they are part of two different product lines. All doors feature genuine stile and rail construction, floating panels, and joints that are glued and doweled. Exterior joints receive marine epoxy, and interior joints receive exterior grade glue. Each door moves through production and gets worked on by our craftsmen with a high level of expertise and attention to detail.

| <u>DISTINCTIVE DOOR SOLUTIONS</u> <i>Uniquely Crafted</i> | <u>CLASSIC DOOR SOLUTIONS</u> <i>Semi-Custom & Value</i> |
|---|--|
| Architecturally Driven | Select Options + Build |
| Your design can be completely custom to meet your specifications (ie: layout, sizes, profiles, species, jambs, etc.) | Your design must fall under our predefined parameters (ie: layout, sizes, profiles, species, jambs, etc.) |
| Made to Order | Made to Order |
| Standard lead time: within 6 weeks | Faster lead time: within 5 weeks |

| | Features | Exterior | | Interior | |
|-----------------|---|---|---|--|---|
| | | Distinctive | Classic | Distinctive | Classic |
| Design | Layouts | ✓ | ★ | ✓ | ★ |
| | Door Shapes | ✓ | ★ | ✓ | ★ |
| | Panel Raises, Sticking, Molding | ✓ | ★ | ✓ | ★ |
| | Wood Species Options | ✓ | ★ | ✓ | ★ |
| | Glass Options | ✓ | ★ | ✓ | ★ |
| | Hinge Finishes | ✓ | ★ | ✓ | ★ |
| | Species Options | ✓ | ★ | ✓ | ★ |
| Specialty Doors | Flush, Pivot, Carriage, Barn, Oversized | ✓ | | ✓ | |
| | Screen/Storm | ✓ | ★ | | |
| | Coastal Rated, Impact Rated | ✓ | | | |
| | Fire Rated | ✓ | | 20, 45, 60, + 90 Minute Ratings | |
| | Bifold, Slide, Commercial | ✓ | | ✓ | |
| | Louver | ✓ | | ✓ | ★ |
| | Miracle, Clipped Corner, Historical | ✓ | | ✓ | |
| Sizes | Width | ✓ | Ranging from 12"-42" increasing in 1" increments | ✓ | Ranging from 12"-42" increasing in 1" increments |
| | Height | ✓ | Ranging from 68"-96" increasing in 1" increments | ✓ | Ranging from 68"-96" increasing in 1" increments |
| | Door Thickness | ✓ | 1 ¾", 2 ¼" | ✓ | 1 ¾", 1 ¾", 2 ¼" |
| | Screen Door Thickness | ✓ | 1 ½", 1 ¾" | ✓ | |
| | Panel Thickness: Flat | ✓ | ¼", ½" ¾" (note: limited by profile selection) | ✓ | ¼", ½" ¾" (note: limited by profile selection) |
| | Panel Thickness: Raised | ✓ | ¾", 1", 1 ¼", 1 ¾" (note: limited by profile selection) | ✓ | ¾", 1", 1 ¼", 1 ¾" (note: limited by profile selection) |
| | Stile and Rail with Face Dimensions | ✓ | 4 ½" before cope, optional 5 ½" (recommended for mortise locks and custom hardware applications). Center stiles and cross rails: 3". Lock rail: 6" above bottom rail. Bottom rail: 8". Sidelites: 2" stiles with matching rails. Transom: 2" stiles with rails. | ✓ | 4 ½" before cope. Center stiles and cross rails: 3". Lock rail: 6" above bottom rail. Bottom rail: 8". Sidelites: 2" stiles with matching rails. Transom: 2" stiles with rails. |
| | SDL Lites | ✓ | ⅞" wide muntins | ✓ | |
| | TDL Lites | ✓ | ⅞" monolithic, 1 ⅝" insulated | ✓ | ⅞" monolithic |
| Frames | ✓ | Duraframe or matching wood with single or double rabbeted jambs | ✓ | 4 ⅙" and 6 ⅙" finger jointed flat. Solid poplar flat jambs or solid matching flat jambs are available with ½" x 1 ⅝" stops | |
| Construction | Solid Stiles | ✓ | | ✓ | |
| | Engineered Stiles | ✓ | ★ | ✓ | ★ |
| | Custom Sizes (Flats) | ✓ | | ✓ | |
| | Solid Rails | ✓ | ★ | ✓ | ★ |
| Panels | MDF (Interior Paint Grade), Extira (Exterior Paint Grade) | ✓ | ★ | ✓ | ★ |
| | Rim Raised Edge Banded (Stain Grade) | ✓ | ★ | ✓ | ★ |
| | Book Matched Veneer (Stain Grade) | ✓ | ★ | ✓ | ★ |
| | Solid Wood Veneer (Planks; Stain Grade) | ✓ | | ✓ | |
| | Solid Panels (Stain Grade) | ✓ | ★ | ✓ | ★ |

✓ Available in a large variety of options based on your custom specifications

★ Available in predefined options and specifications





WOOD SPECIES OPTIONS

Selecting the type of wood for your doors is often a crucial decision. Let us help you determine which woods work best for exterior or interior application!



Accoya

ⓓ Ⓜ



Alder (Clear)

ⓓ Ⓢ Ⓜ



Ash

ⓓ



Birch

ⓓ



Butternut

ⓓ



Alaskan Yellow Cedar

ⓓ Ⓜ



Western Red Cedar

ⓓ Ⓜ



Spanish Cedar

ⓓ Ⓢ Ⓜ



Cherry

ⓓ Ⓢ



Cypress

ⓓ



Douglas Fir (Vertical Grain)

ⓓ Ⓢ Ⓜ



Hickory

ⓓ



Knotty Alder

ⓓ



African Mahogany

ⓓ Ⓢ Ⓜ

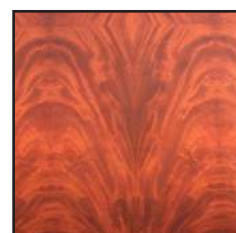

Crotch Mahogany (Veneer Only)

ⓓ Ⓜ



Genuine Mahogany

ⓓ Ⓜ



Maple (Hard)

ⓓ Ⓢ



Maple (Soft)

ⓓ



MDF

ⓓ Ⓢ



Red Oak, Plain Sawn

ⓓ Ⓢ

ⓓ Available Under Distinctive Line

Ⓢ Available Under Classics Line

Ⓜ Warranted for Exterior Use



SPECIALTY VENEER OPTIONS

Looking for designer or exotic veneer? We can order specialty veneer to match any project. You can also provide your own veneer and we can incorporate it into your door!



Red Oak,
Quarter Sawn
D



Red Oak,
Rift Sawn
D



White Oak,
Plain Sawn
D C H



White Oak,
Quarter Sawn
D H



White Oak,
Rift Sawn
D H



Clear White Pine
D



Antique
Heart Pine
D



Knotty Pine
D



Radiata Pine
D C



Yellow Pine
D



Poplar
D C



Redwood
D



Red Grandis
D H



Sapele,
Quarter Sawn
D C



Teak
D H



Utile
D H



Walnut,
Plain Sawn
D



Walnut,
Quarter Sawn
D



Walnut Burl
(Veneer Only)
D H



Wormy Chestnut
D

D Available Under Distinctive Line

C Available Under Classics Line

H Warrantied for Exterior Use

MATERIAL SELECTION

We offer two different materials to construct your door out of: wood and MDF. Both are high quality options, but each are recommended for different applications.

DOUBLE REFINED MDF

MDF is highly recommended for paint grade applications as it offers a crisp and smooth painting surface.



More cost effective



More structurally stable



Smoother painting surface



Provides a higher sound barrier

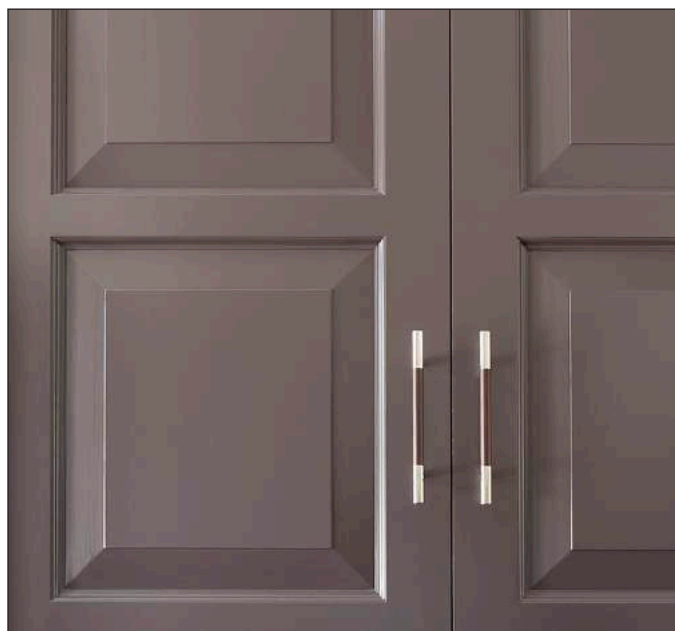

WOOD

Wood is highly recommended for applications where the customer wants the natural look of wood grain, which can be enhanced by stain or a clear top coat.



Offers a natural, tight wood grain



Lightweight for an easy swing



Provides the natural strength of wood (inserts are not needed)



Made of 100% natural materials



Heirloom Quality

MDF DOOR SOLUTIONS

APPLICATION



MDF offers a crisper profile and smooth surface for painting, which is ideal for interior applications.

QUALITY



We use double refined MDF, which is stronger and denser than standard MDF.

CONSTRUCTION



All joints are coped and doweled to create a long lasting product.

STRENGTH



A solid wood insert is installed on the hinge and strike sides with 7 points of contact which is engineered for increased surface area.

STYLE



All doors, whether wood or MDF, can have the same profile or sticking to ensure a cohesive design in the home.

MACHINING



Doors are machined using state-of-the-art CNC technology. We downsize, bevel, and machine for hardware.

STICKING OPTIONS

STANDARD STICKING OPTIONS:

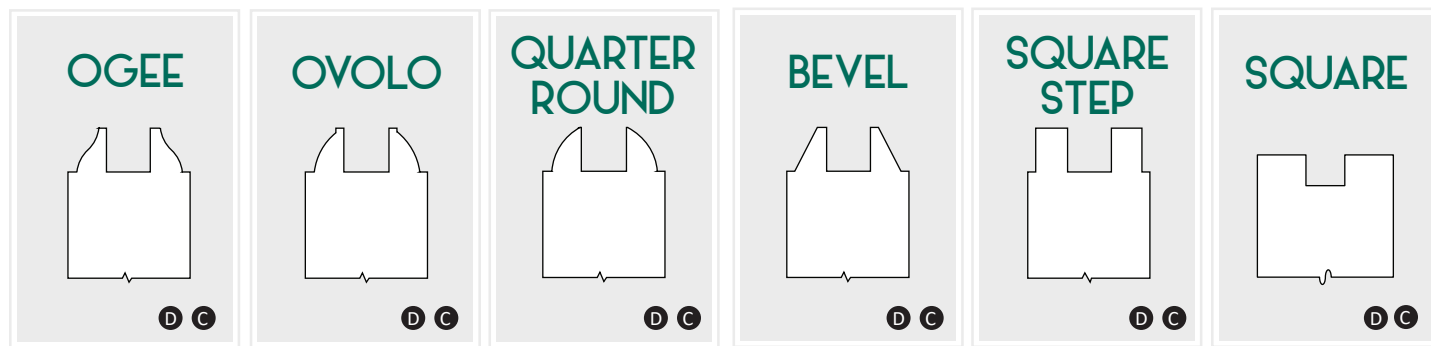

ARCHITECTURAL STICKING OPTIONS:

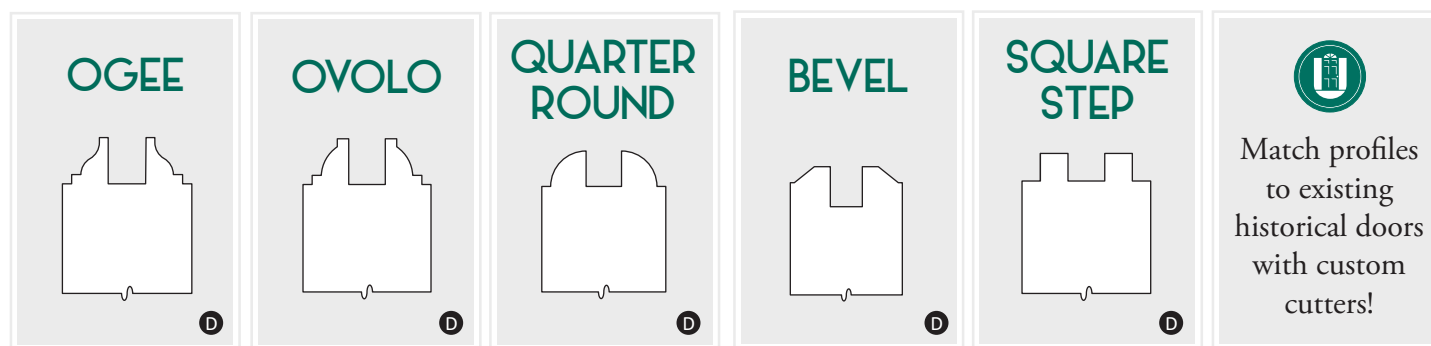

Ask us about additional Distinctive sticking options!

COMMON LAYOUTS

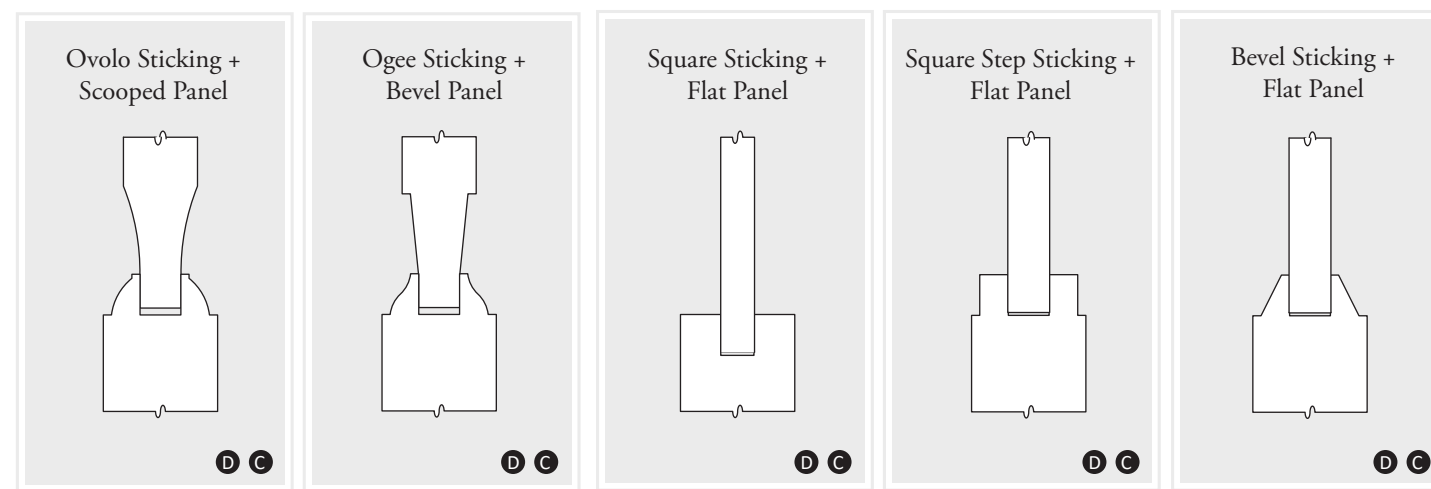

Truly customize your door by selecting two different panel options for each side. This is a great solution to have the front of an exterior door look different than the back, or for rooms that have different aesthetics. To customize your door even further, choose different species for each side.

D Available Under Distinctive Line

C Available Under Classics Line

To view specific dimensions for sticking and panels, please visit our website. Contact us today to create your own custom design!



Style

PANEL OPTIONS

STANDARD PANEL OPTIONS:

SCOOP



MDF Only **D C**

SINGLE HIP

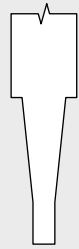

D C

DOUBLE HIP



D C

FLAT



D C



ARCHITECTURAL PANEL OPTIONS:

SCOOP



D

SINGLE HIP

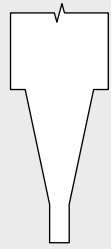

D

DOUBLE HIP



D

RAISED BEAD

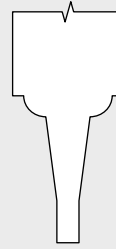

D



Add architectural interest by customizing each panel to meet your exact specifications.

Ask us about additional Distinctive panel options!

SPECIALTY PANEL OPTIONS

Add extra decorative flair by carving in v-grooves, beads, or tongue & groove details to the panels of your door.

V-GROOVE



D C

SQUARE KERF



D

BEAD



D

V-GROOVE/ BEAD



D

Note: In exterior applications, the grooves will stop short of the rails to prevent water infiltration.

D Available Under Distinctive Line

C Available Under Classics Line

For questions, please call our door experts at 800-570-8283



SDL + TDL BAR OPTIONS

To complement your door, select from a number of SDL and TDL options. Looking for the perfect detail? Ask about matching muntins and sticking!



M-OG-109

D C

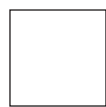

M-DD-101

D C

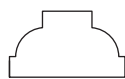

M-OV-106

D C

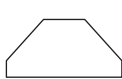

M-BV-104

D

SDL Spacer Bar Options

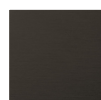

Bronze

D C



Mill

D C

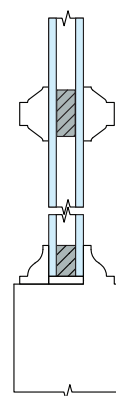

M-OG-104 +
S-OG-113

D

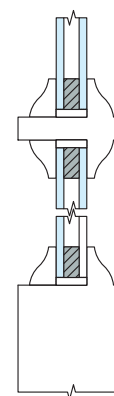

S-OG-121

D C

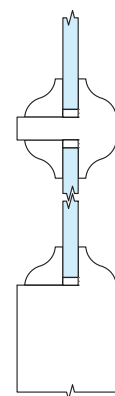

S-OG-122

D C

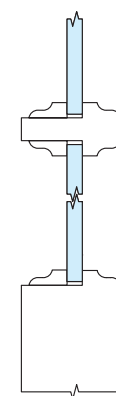

S-OG-103

D C

MOLDING OPTIONS

APPLIED MOLDING OPTIONS:

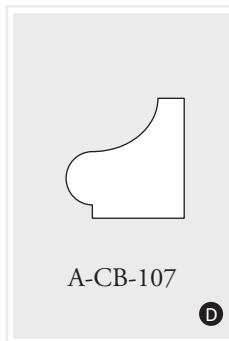
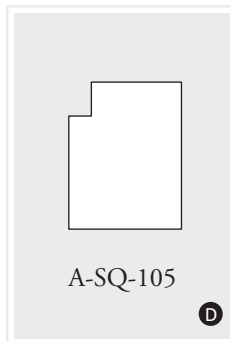
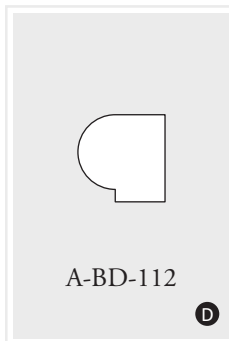
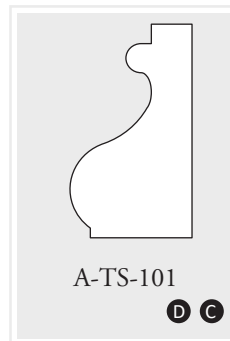
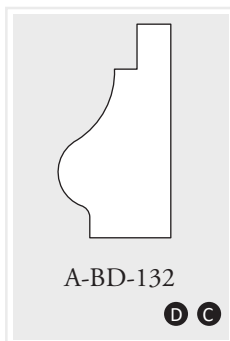
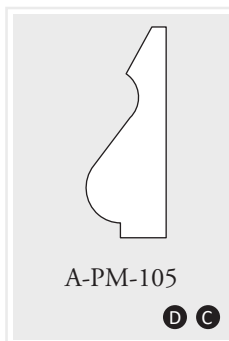

RAISED MOLDING OPTIONS:

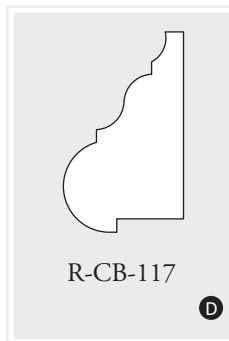
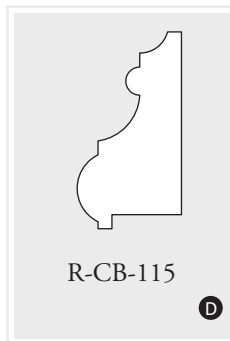
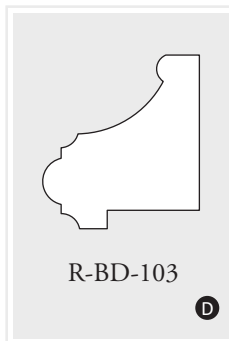
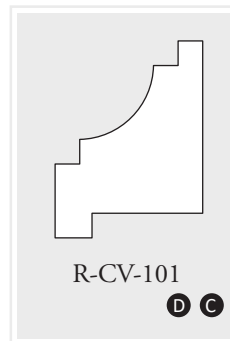
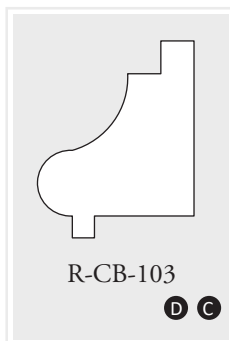
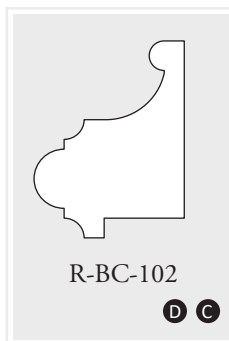



GLASS OPTIONS

With over 15 different glass types and the ability to customize any leaded or wrought iron application, we can create a truly unique addition to any space in your home. Some size restrictions apply.



Acid Etched

D C



Aquatex

D

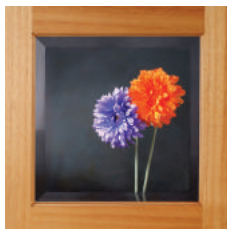

Beveled Edge

D C



Clear

(Low E and Argon available)

D C



Flemish

D



Glue Chip

D C



Heavy Restoration

D



Light Restoration

D



Rain

D C



Seedy

D C



Thin Reeded

D



Water

D C



White Laminated

D C

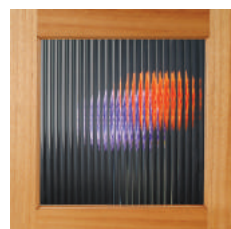

Wide Reeded

D



Winter Lake

D



Leaded - 50 Stars

D



Leaded - Harden

D



Leaded - Brannon

D



Wrought Iron

D



Mirror

D C

Custom Caming Options



Antique Patina



Patina



Zinc



Brass

For more custom design options or to inquire about other types of glass, give us a call!



Custom Sandblasting

D

D Available Under Distinctive Line

C Available Under Classics Line



WROUGHT IRON APPLICATIONS

We pride ourselves on using vendors that value the same craftsmanship and commitment that we do. Our wrought iron vendor is a prime example of a company that produces quality architectural metalwork for custom doors. Please note that even though we only are showing a few different options below, these are just a small sliver of what can be done and are there to inspire your next dream door!



For questions, please call our door experts at 800-570-8283

FRAMES

Many variables affect the difficulty of hanging a door in the field. The manner in which a door is hung will determine how it looks and performs after installation. Items such as reveals, machining, and the type of frame will have an impact on the end result. Let us help you choose the right options for your job!

EXTERIOR OPTIONS

Single Rabbeted Frames



Double Rabbeted Frames



Finger Jointed Frame with Alaskan Yellow Cedar



INTERIOR OPTIONS

Solid Frame with Tacked In Stop



Rabbeted Solid Frame

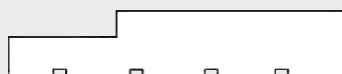

Double Rabbeted Solid Frame



Finger Jointed Frame with Tacked In Stop



Finger Jointed Rabbeted Frame



Finger Jointed Double Rabbeted Frame



STOP OPTIONS

We offer a variety of decorative door stops. Other custom options are available!

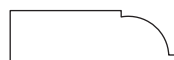

DS-101

D **C**

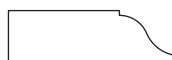

DS-102

D **C**

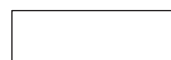

DS-103

D **C**

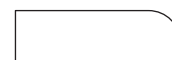

DS-110

D **C**

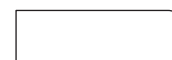

DS-108

D **C**

CASING OPTIONS



Flat

D **C**

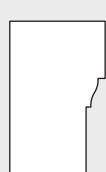

Brickmold
CAS-312

D **C**



CAS-104

D



CAS-105

D



CAS-112

D



CAS-306

D

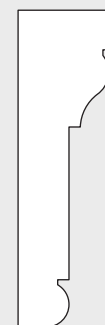

CAS-309

D



CAS-404

D

D Available Under Distinctive Line

C Available Under Classics Line

SILL OPTIONS

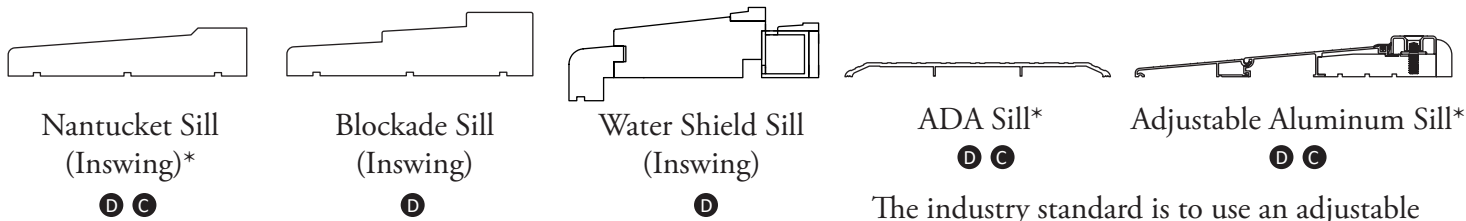

Nantucket Sill
(Inswing)*
D C

Blockade Sill
(Inswing)
D

Water Shield Sill
(Inswing)
D

ADA Sill*
D C

Adjustable Aluminum Sill*
D C

* Outswing Options Available

We prefer to use solid wood sills to complete the look of an entire wood door, which complements the architectural detail of the home. Our Blockade sill helps push water away from the door and is preferred in coastal applications.

Wood sills can be finished the same color as the door.

The industry standard is to use an adjustable aluminum sill. We also offers this as an option.



Bronze
D C



Mill
D C

Contact us for more finish options!



WEATHERSTRIPPING + DOOR BOTTOM OPTIONS

COMPRESSION WEATHERSTRIPPING



D C

Available in black, brown, or white (interior or exterior)

DOOR BOTTOM OPTIONS



Inswing Interlock
D C

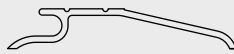

Outswing Interlock
D C



Intek Sweep
(Inswing or Outswing)
D C



Automatic Door Bottom
D

Available in brass, bronze, and mill

DRIP CAP + ASTRAGAL OPTIONS

DRIP CAP

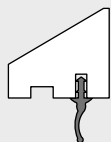

D C

Engineered to push water away from the door

ASTRAGAL OPTIONS

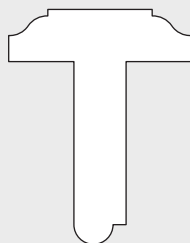

AST-301
(Interior)
D C



AST-401
(Interior & Exterior)
D C

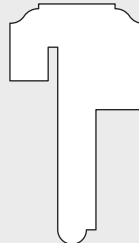

AST-101
(Exterior)
D C

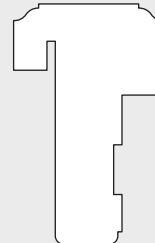

AST-205
(Exterior)
D C



Note: T Astragals are fastened with screws for easy removal.

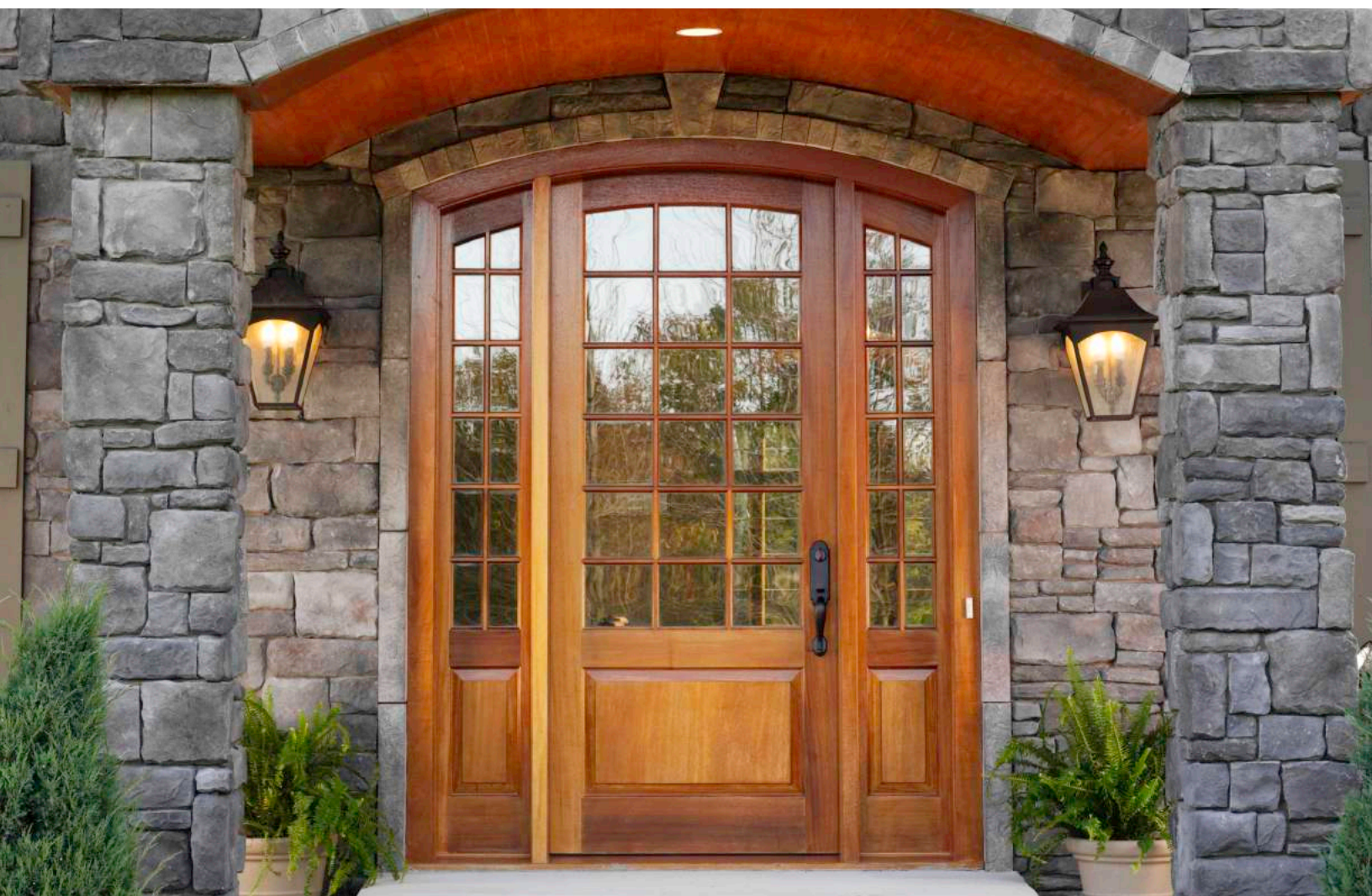
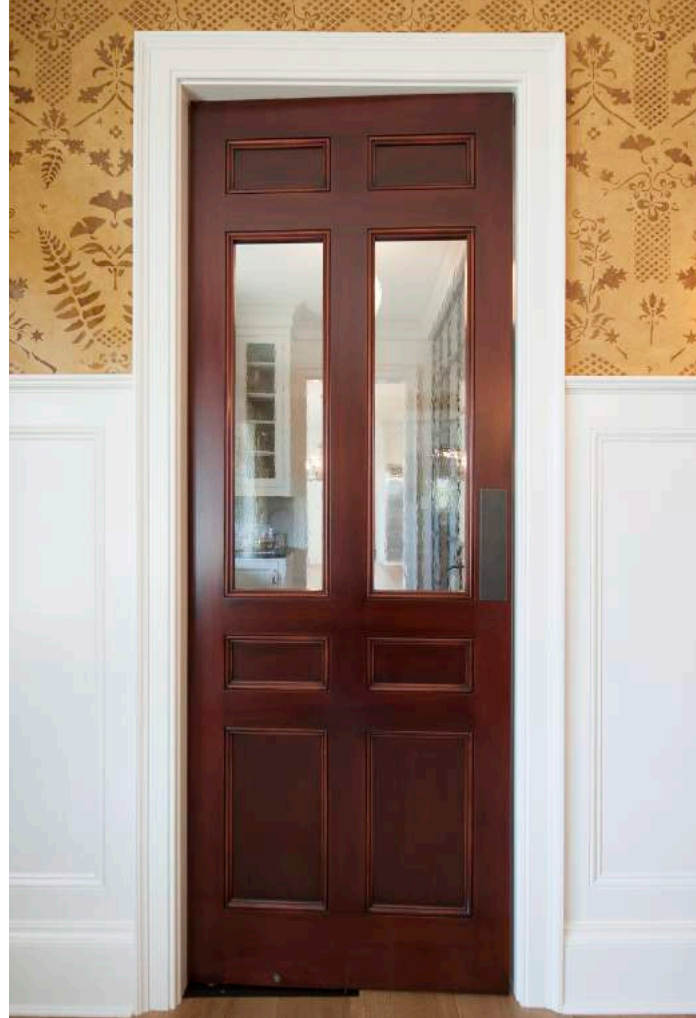



HINGE OPTIONS

Our standard exterior door hinge is a square corner ball bearing solid brass hinge, aimed to support the weight of your door. Our interior doors typically come in a plain bearing square corner hinge in a plated steel material.



Square Corner Hinges
Shown in Oil Rubbed Bronze

D C



Radius Corner Hinges
Shown in Antique Brass

D C



Square Barrel Hinges
Shown in Satin Nickel

D C



Acorn Tip

D C



Ball Tip

D C



Steeple Tip

D C



Center Pivot Hinges
Shown in Stainless Steel

D C



Offset Pivot Hinges
Shown in Stainless Steel

D C



Harmon Hinges
Shown in Polished Brass

D



Looking for something different? Contact us for more options, or provide your own hinges and we can incorporate them into your design!



Soss Hinges
(Concealed Hinges)
Shown in Stainless Steel

D



Tectus Hinges
(Concealed Hinges)
Shown in Satin Chrome

D



Olive Knuckle Hinges
Shown in Polished Chrome

D

Hinge manufacturers that complement our product include: Baldwin®, Emtek®, Hager®, Deltana®, Rixson®, Soss®, Tectus®, and Bommer®. Please note that specialty hardware may have longer lead times.

D Available Under Distinctive Line

C Available Under Classics Line



HINGE FINISHES

From contemporary to classic, you'll find a variety of hinge finishes available. If you don't see what you're looking for, send us your own hinges or hardware and we can easily accommodate them into your design with our state-of-the-art CNC machining.



Oil Rubbed Bronze
US10B
D C



Satin Nickel
US15
D C



Polished Brass
US3
D C

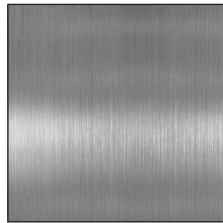

Stainless Steel
US32
D C

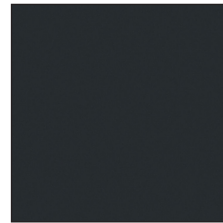

Matte Black
US19
D C



Satin Chrome
US26D
D C



French
Antique Brass
US7
D C

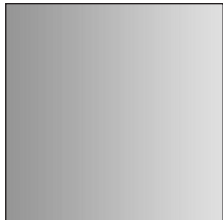

Polished Chrome
US26
D C



Pewter
US15A
D C



Satin Brass
US4
D C



Polished Nickel
US14
D C

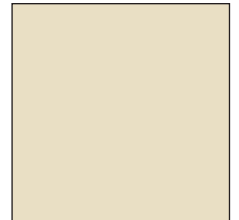

Primed Steel
USP
D C

D Available Under Distinctive Line

C Available Under Classics Line

For questions, please call our door experts at 800-570-8283



MULTIPOINT HARDWARE

Protecting your home, your loved ones and your investment is top priority at Upstate Door. Multipoint locking options are available on virtually every exterior application we build, adding security and stability to your door.

Constructed in stainless steel, our G-U Multipoint hardware options provide a secure locking system for your exterior doors. The locking mechanism improves the structural integrity of your door. This minimizes warping caused by severe weather conditions and/or the natural movement of wood itself.



Ask us about handlesets that are compatible with multipoint hardware!

For use with automatic multipoint on a single door or the active door in a double door system:

For use with automatic multipoint on the inactive door on a double door system:

Automatic Multipoint is our standard system and is used on many single doors or active doors in a double door system

3 Point S Bolts are only used when the door is Impact Rated

One-handed flush bolts are preferred for taller doors

2 Point S-Bolts are preferred when the user wants the hardware concealed

Flush bolts are used as another alternative to the one-handed flush bolt



INTERIOR DOUBLE DOOR HARDWARE SOLUTIONS



Magnetic catches are preferred for interior double doors - they are quiet and smooth



Ball and roller catches are used for interior double doors and click when they are closed



Flush bolts can also be used on interior doors to hold the door in place



Surface bolts are a more decorative way to hold double doors in place



DOOR CONSTRUCTION

Each door receives individualized attention from our expert craftsmen. Our doors are built to your exact specifications. Premium materials are always used; each piece of lumber is hand selected for quality and our MDF is double-refined to ensure crisp details and the smoothest paint application available.



Genuine stile and rail construction



Stave core stiles are used for structural stability



Joints are coped and doweled to create a long lasting, high quality product



Muntins are doweled for added strength and support



Different cores are available based on different applications to maximize stability



Raised and flat floating panels are standard



Marine epoxy is used on exterior doors; exterior grade glue is used on interior doors



CNC machining is used on every unit to create hinge pockets, jambs, details, etc.

Elegance

PANEL CONSTRUCTION

Paneled wood doors offer a classic look that people often want for their homes. Within the door industry, there are four types of panel construction methods. Each panel varies in construction and style. We adhere to AWI Premium Specifications when possible.

STANDARD: RIM-RAISED PANELS WITH BOOK-MATCHED VENEER

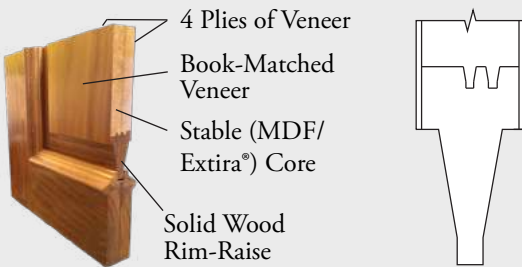

Book-matched veneer, horizontal and vertical;
Limited movement

PREMIUM: RIM-RAISED PANELS WITH SOLID WOOD PLANKS

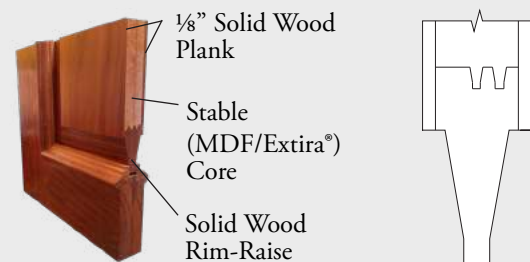

1/8" solid wood planks (vertically matched);
Limited movement

ALSO AVAILABLE: SOLID WOOD PANELS

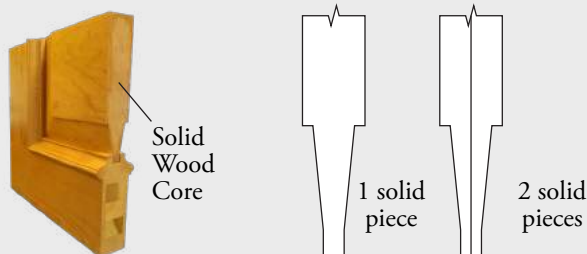

Only warrantied in panels narrower than 14"



Rim Raised Panel Construction



Ask us about creating stationary windows to complement your sidelites!





STILE CONSTRUCTION

One downside of a solid wood stile is that solid wood has a tendency to move, causing a door to warp. To minimize warpage, we glue different boards together in alternating directions. If the boards try to warp, they end up fighting against the other boards and are held straight. Upstate Door craftsmen take these pieces of wood and glue a solid, thinner piece of wood to each face and edge. By doing this, we create a product that appears as a single piece of wood but is much more stable than solid wood.

SOLID CORE



Available with many designs

STAVE CORE



Required based on specific parameters

LVL CORE





Made-To-Order

CNC MACHINING

Every door we manufacture is machined using a CNC router, making the tolerances extremely accurate. We pride ourselves on offering high quality doors that fit properly while offering architectural detail.

CONSISTENCY

CNCs offer a horizontal aggregate; the door is held flat while it is being machined. Everything is done consistently, such as beveling or depths of hinge pockets.

FLEXIBILITY

We have complete flexibility with any type of door, so creating custom door layouts or accommodating custom hinge layouts is never an issue.

ACCURACY

Tolerances are extremely accurate, which makes every made-to-order unit detailed and precise.

We can accommodate any door in any design. Personalize your door with kerfs, grooves, beads, or other intricate designs for added architectural elements.





DECORATIVE OPTIONS

Personalize your door with applied pieces of decorative MDF or wood, or have a decorative item carved out of a midrail or panel! Our CNC technology allows us to create different shaped panels. Choose from standard options or have our CAD drafting team create something completely unique.



DECORATIVE SHELF OPTIONS

Add a shelf to any unit for a vintage Craftsman style. Ask us about including shelves on Distinctive sidelites!

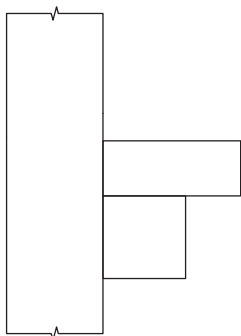

Standard
Dentil Shelf

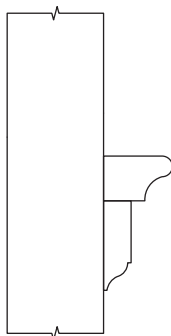

Standard
Profile Shelf

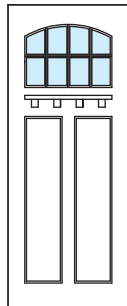

D D2130.1
(4w x 2h)

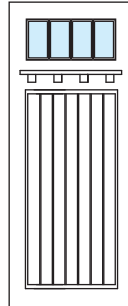

D D2121
(4w x 1h)

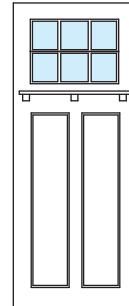

D D2130
(3w x 2h)

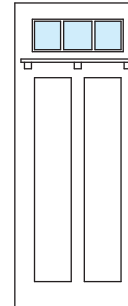

D D2122
(3w x 1h)

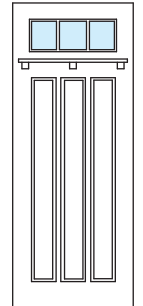

D D2150
(3w x 1h)

SQUARE TOP DOOR WITH SQUARE PANEL LAYOUTS

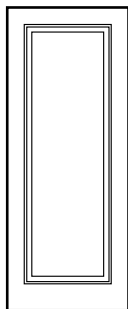

C C1000
D D1000

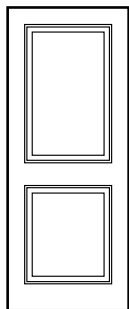

C C1040
D D1040

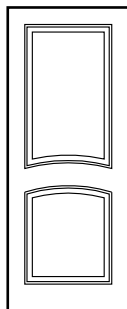

C C1070
D D1070

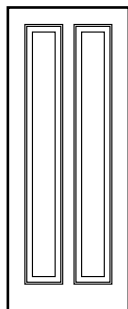

C C1100
D D1100

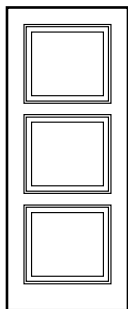

C C1130
D D1130

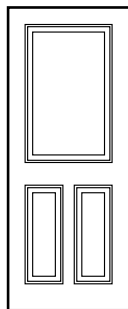

C C1160
D D1160

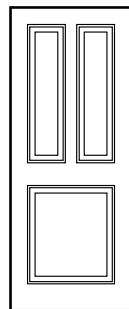

C C1190
D D1190

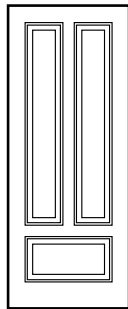

C C1200
D D1200

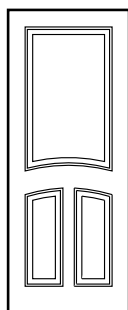

C C1210
D D1210

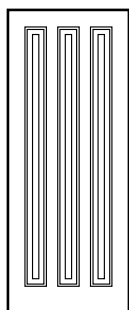

C C1230
D D1230

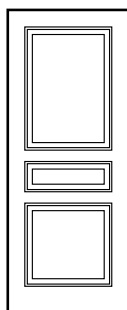

C C1240
D D1240

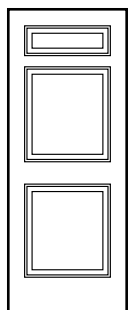

C C1250
D D1250

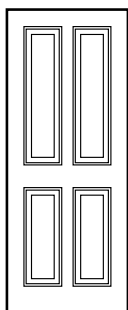

C C1280
D D1280

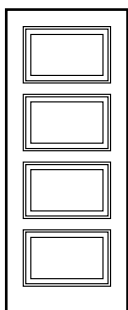

C C1330
D D1330

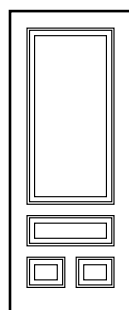

C C1340
D D1340

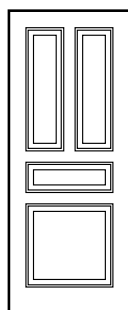

C C1360
D D1360

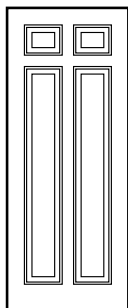

C C1390
D D1390

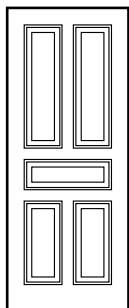

C C1400
D D1400

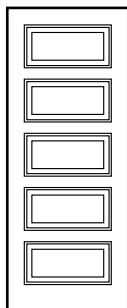

C C1430
D D1430

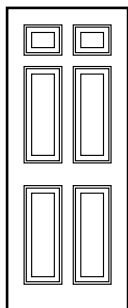

C C1440
D D1440

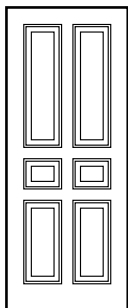

C C1470
D D1470

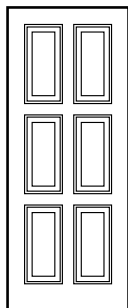

C C1480
D D1480

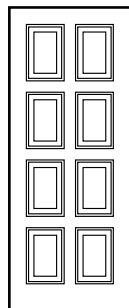

C C1500
D D1500

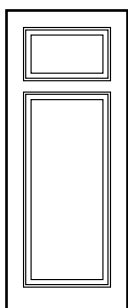

C C1540
D D1540

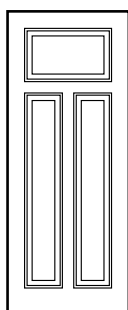

C C1550
D D1550

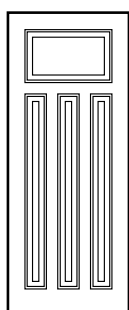

C C1560
D D1560

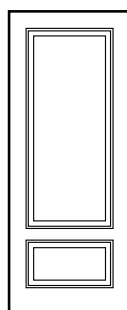

C C1570
D D1570

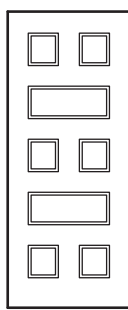

D D1830

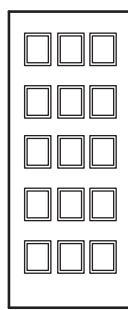

D D1150

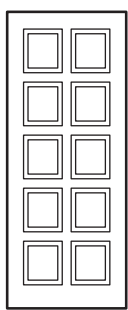

D D1820

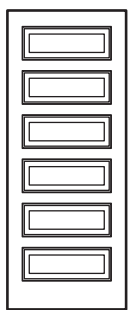

D D1610

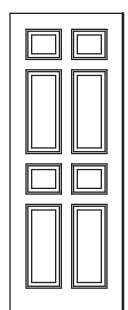

D D1810



Timeless

SQUARE TOP DOOR WITH SQUARE PANEL LAYOUTS

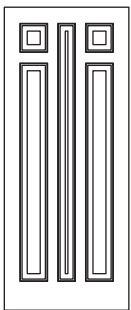

D D1561

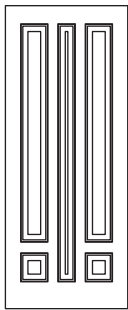

D D1562

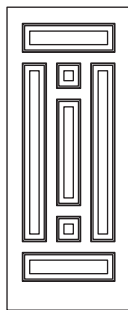

D D1710

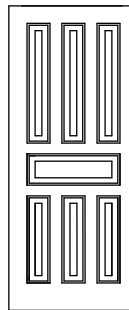

D D1700

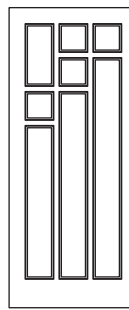

D D1800

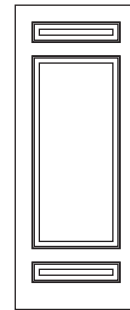
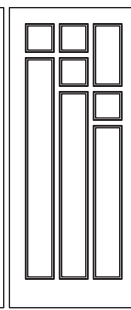

D D1131

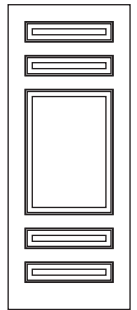

D D1431

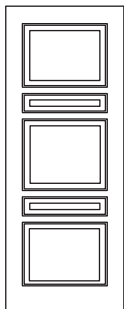

D D1432

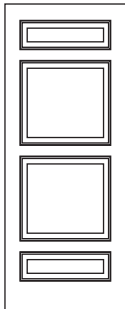

D D1331

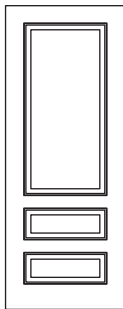

D D1341

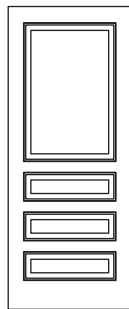

D D1600

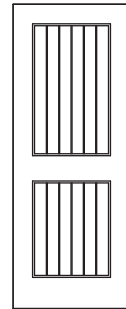

D D1041



SQUARE TOP DOOR WITH ARCHED PANEL LAYOUTS

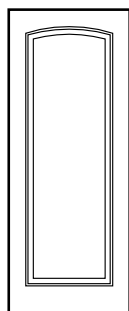

C C1000.1
D D1000.1

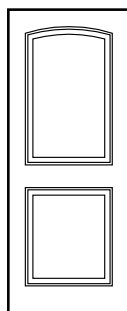

C C1040.1
D D1040.1

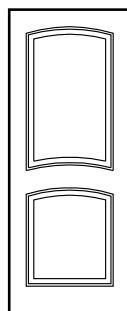

C C1070.1
D D1070.1

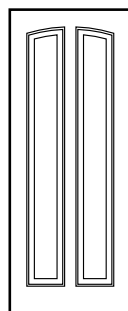

C C1100.1
D D1100.1

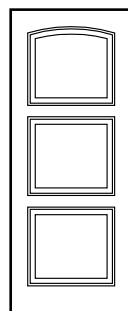

C C1130.1
D D1130.1

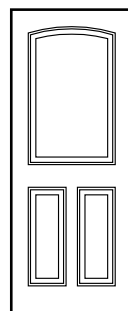

C C1160.1
D D1160.1

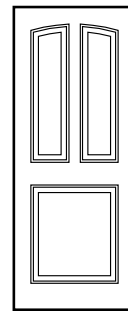

C C1190.1
D D1190.1

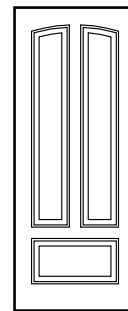

C C1200.1
D D1200.1

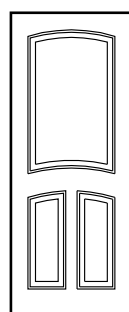

C C1210.1
D D1210.1

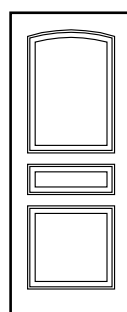

C C1240.1
D D1240.1

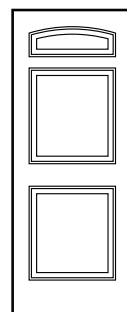

C C1250.1
D D1250.1

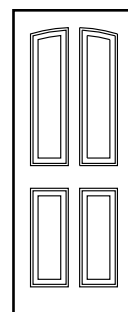

C C1280.1
D D1280.1

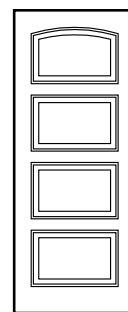

C C1330.1
D D1330.1

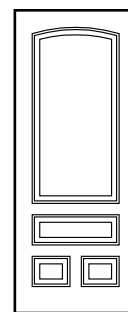

C C1340.1
D D1340.1

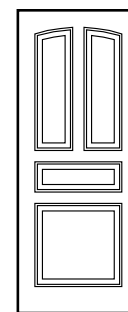

C C1360.1
D D1360.1

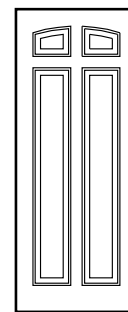

C C1390.1
D D1390.1

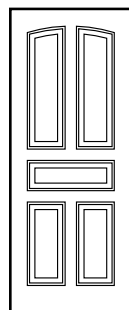

C C1400.1
D D1400.1

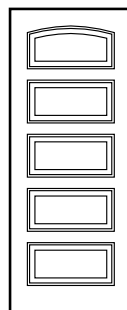

C C1430.1
D D1430.1

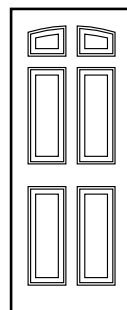

C C1440.1
D D1440.1

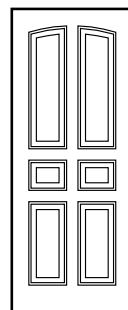

C C1470.1
D D1470.1

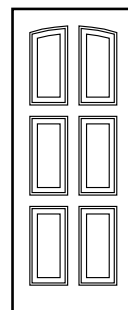

C C1480.1
D D1480.1

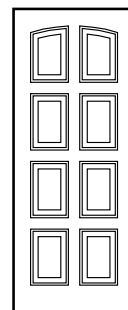

C C1500.1
D D1500.1

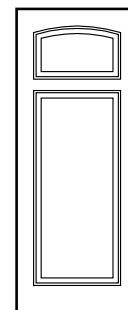

C C1540.1
D D1540.1

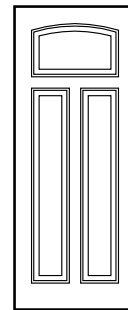

C C1550.1
D D1550.1

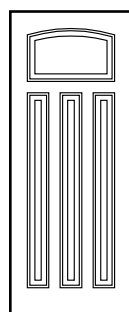

C C1560.1
D D1560.1

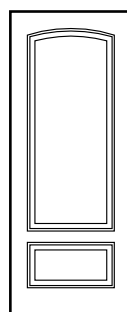

C C1570.1
D D1570.1

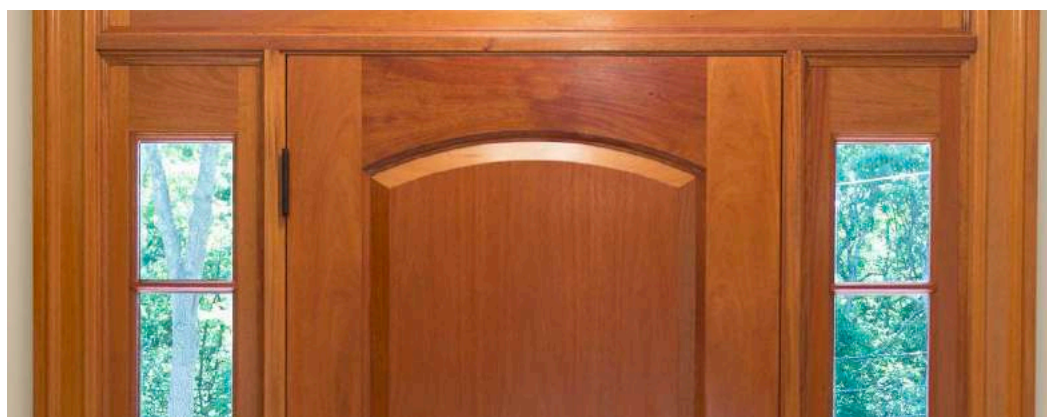

ARCHED TOP DOOR WITH ARCHED PANEL LAYOUTS

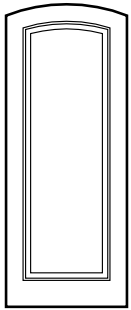

C C1000.2
D D1000.2

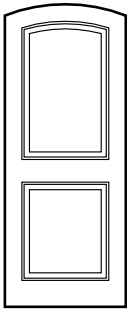

C C1040.2
D D1040.2

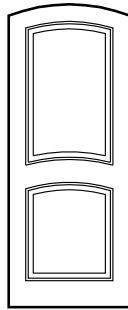

C C1070.2
D D1070.2

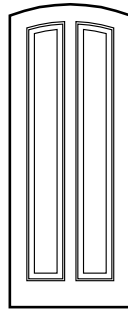

C C1100.2
D D1100.2

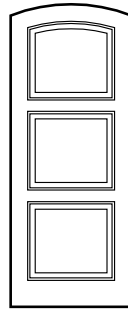

C C1130.2
D D1130.2

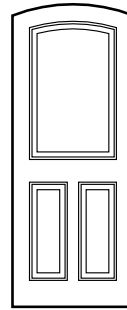

C C1160.2
D D1160.2

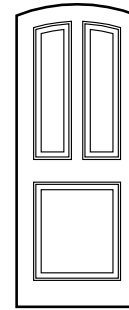

C C1190.2
D D1190.2

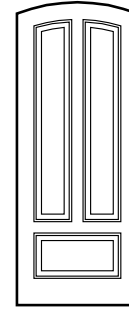

C C1200.2
D D1200.2

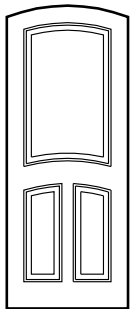

C C1210.2
D D1210.2

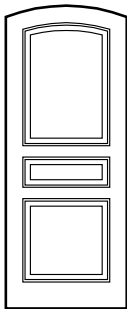

C C1240.2
D D1240.2

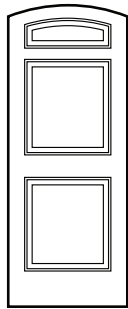

C C1250.2
D D1250.2

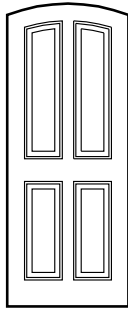

C C1280.2
D D1280.2

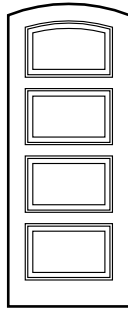

C C1330.2
D D1330.2

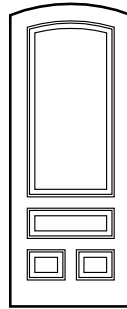

C C1340.2
D D1340.2

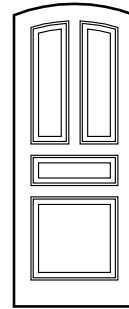

C C1360.2
D D1360.2

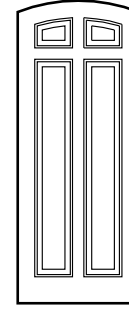

C C1390.2
D D1390.2

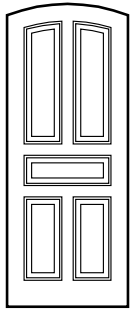

C C1400.2
D D1400.2

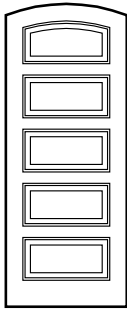

C C1430.2
D D1430.2

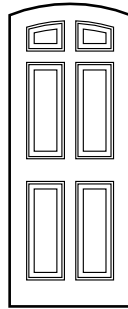

C C1440.2
D D1440.2

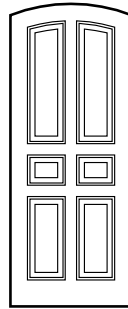

C C1470.2
D D1470.2

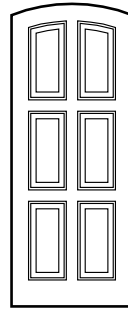

C C1480.2
D D1480.2

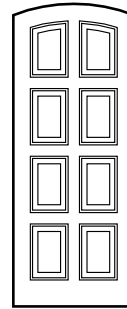

C C1500.2
D D1500.2

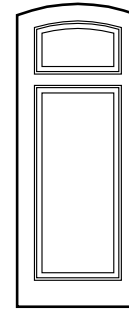

C C1540.2
D D1540.2

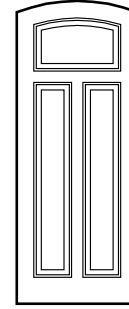

C C1550.2
D D1550.2

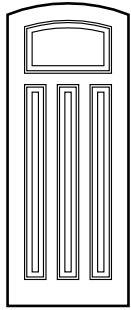

C C1560.2
D D1560.2

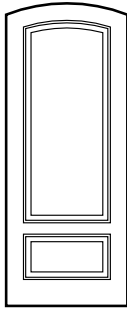

C C1570.2
D D1570.2



SQUARE TOP DOOR WITH RADIUS PANEL LAYOUTS

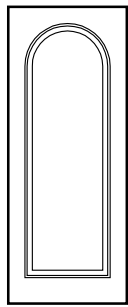

C C1000.3
D D1000.3

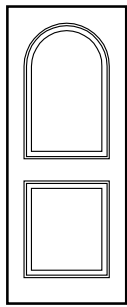

C C1040.3
D D1040.3

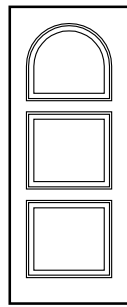

C C1130.3
D D1130.3

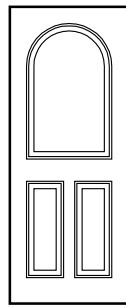

C C1160.3
D D1160.3

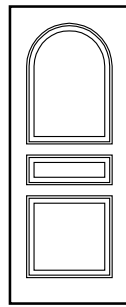

C C1240.3
D D1240.3

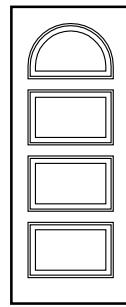

C C1330.3
D D1330.3

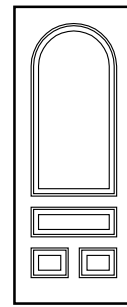

C C1340.3
D D1340.3

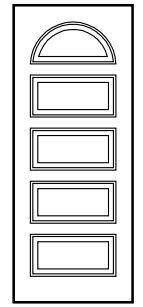

C C1430.3
D D1430.3

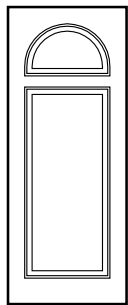

C C1540.3
D D1540.3

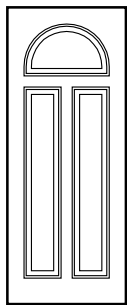

C C1550.3
D D1550.3

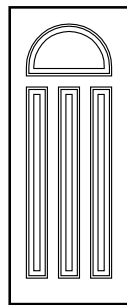

C C1560.3
D D1560.3

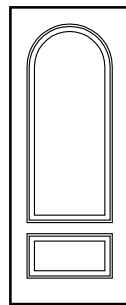

C C1570.3
D D1570.3

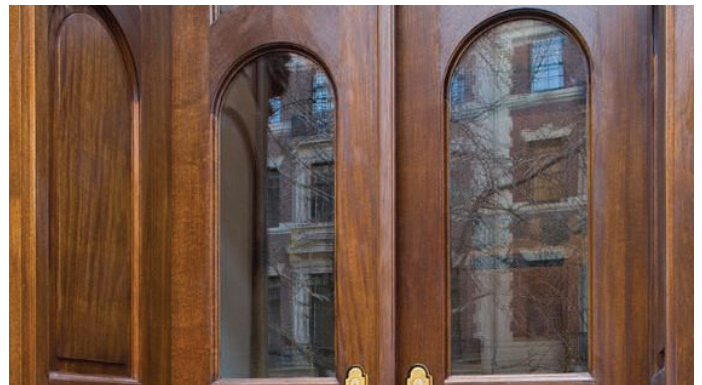

RADIUS TOP DOOR WITH RADIUS PANEL LAYOUTS

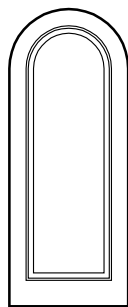

C C1000.4
D D1000.4

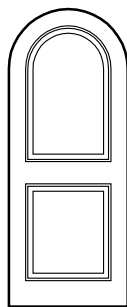

C C1040.4
D D1040.4

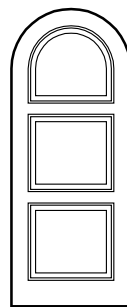

C C1130.4
D D1130.4

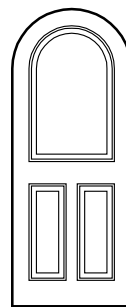

C C1160.4
D D1160.4

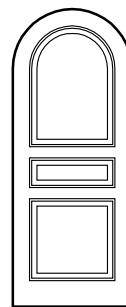

C C1240.4
D D1240.4

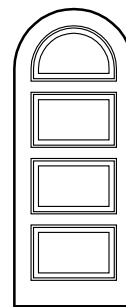

C C1330.4
D D1330.4

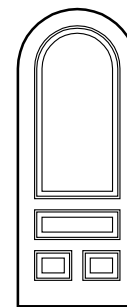

C C1340.4
D D1340.4

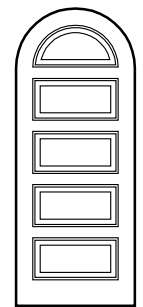

C C1430.4
D D1430.4

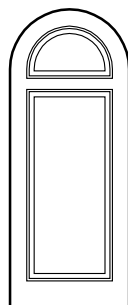

C C1540.4
D D1540.4

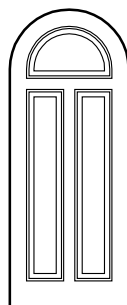

C C1550.4
D D1550.4

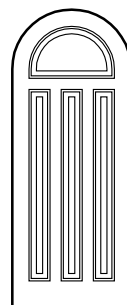

C C1560.4
D D1560.4

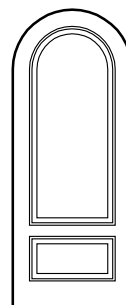

C C1570.4
D D1570.4





SQUARE TOP DOOR WITH FRENCH CURVE PANEL LAYOUTS

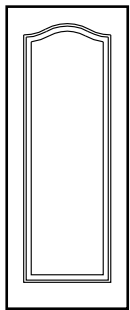

C C1000.5
D D1000.5

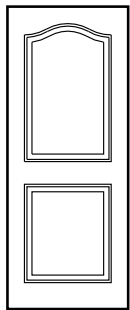

C C1040.5
D D1040.5

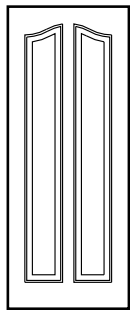

C C1100.5
D D1100.5

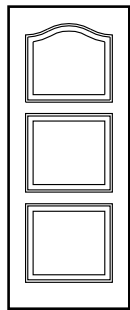

C C1130.5
D D1130.5

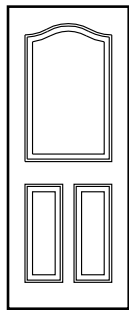

C C1160.5
D D1160.5

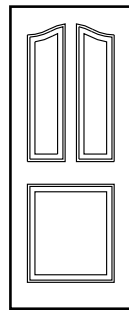

C C1190.5
D D1190.5

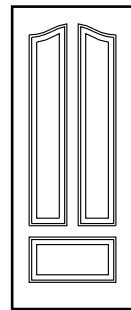

C C1200.5
D D1200.5

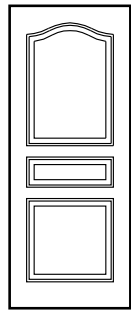

C C1240.5
D D1240.5

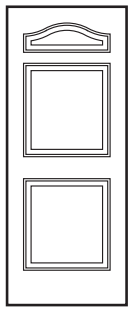

C C1250.5
D D1250.5

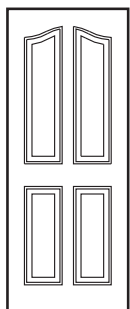

C C1280.5
D D1280.5

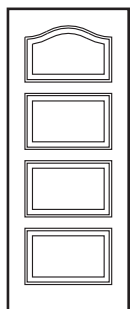

C C1330.5
D D1330.5

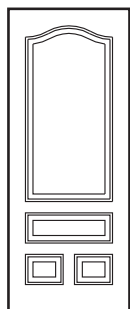

C C1340.5
D D1340.5

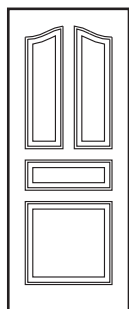

C C1360.5
D D1360.5

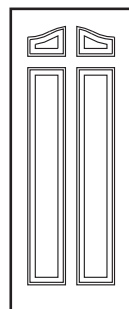

C C1390.5
D D1390.5

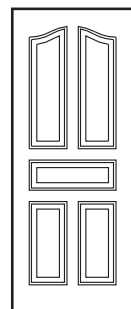

C C1400.5
D D1400.5

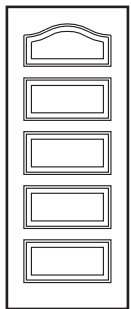

C C1430.5
D D1430.5

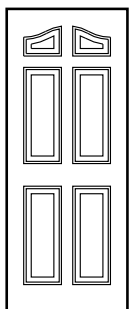

C C1440.5
D D1440.5

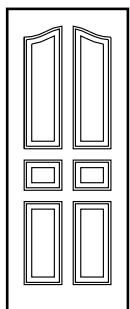

C C1470.5
D D1470.5

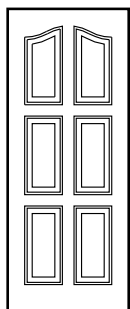

C C1480.5
D D1480.5

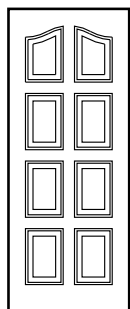

C C1500.5
D D1500.5

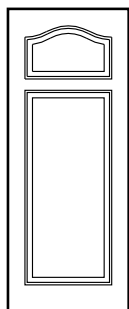

C C1540.5
D D1540.5

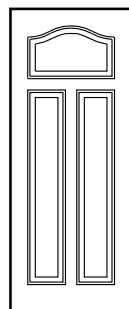

C C1550.5
D D1550.5

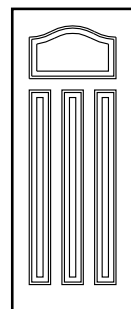

C C1560.5
D D1560.5

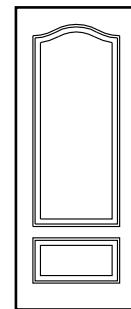

C C1570.5
D D1570.5

SQUARE TOP DOOR WITH SQUARE GLASS LAYOUTS

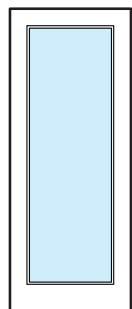

C C2000
D D2000

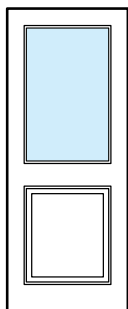

C C2050
D D2050

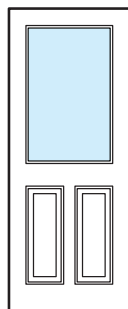

C C2070
D D2070

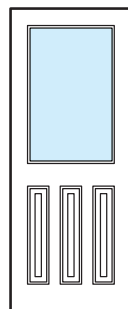

C C2590
D D2590

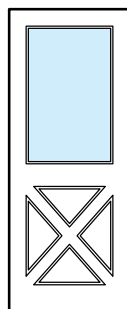

C C2080
D D2080

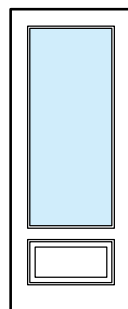

C C2090
D D2090

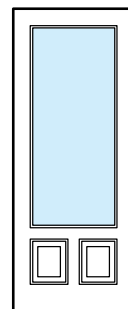

C C2600
D D2600

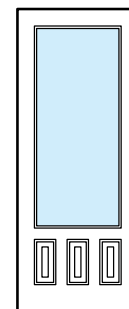

C C2610
D D2610

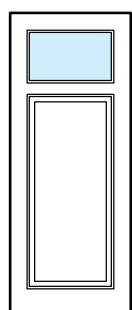

C C2560
D D2560

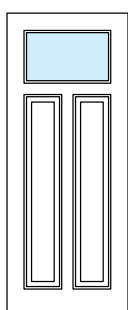

C C2110
D D2110

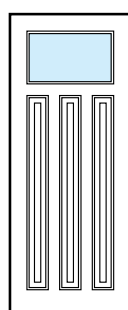

C C2140
D D2140

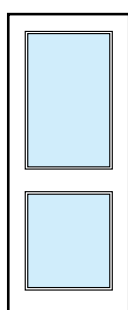

C C2160
D D2160

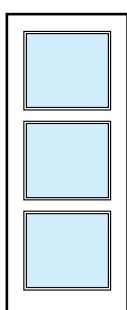

C C2170
D D2170

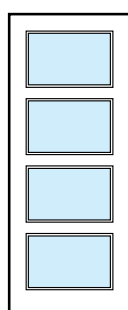

C C2190
D D2190

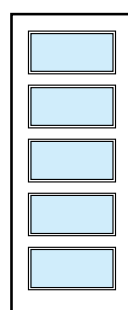

C C2230
D D2230

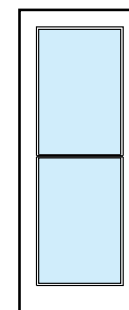

C C2000 (1w x 2h)
D D2000 (1w x 2h)

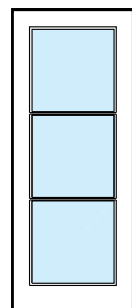

C C2000 (1w x 3h)
D D2000 (1w x 3h)

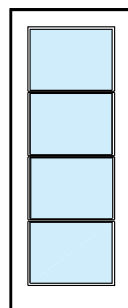

C C2000 (1w x 4h)
D D2000 (1w x 4h)

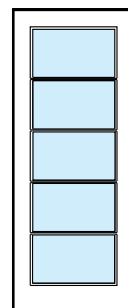

C C2000 (1w x 5h)
D D2000 (1w x 5h)

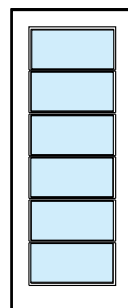

C C2000 (1w x 6h)
D D2000 (1w x 6h)

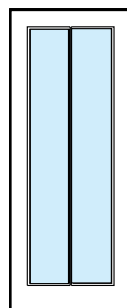

C C2000 (2w x 1h)
D D2000 (2w x 1h)

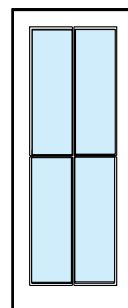

C C2000 (2w x 2h)
D D2000 (2w x 2h)

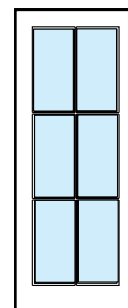

C C2000 (2w x 3h)
D D2000 (2w x 3h)

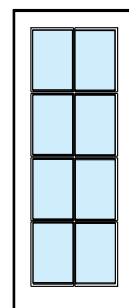

C C2000 (2w x 4h)
D D2000 (2w x 4h)

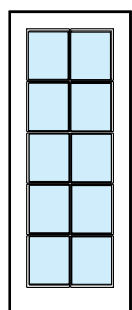

C C2000 (2w x 5h)
D D2000 (2w x 5h)

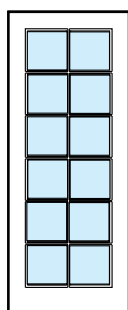

C C2000 (2w x 6h)
D D2000 (2w x 6h)

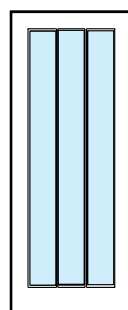

C C2000 (3w x 1h)
D D2000 (3w x 1h)

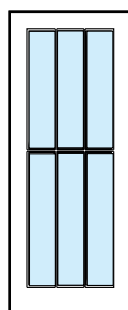

C C2000 (3w x 2h)
D D2000 (3w x 2h)

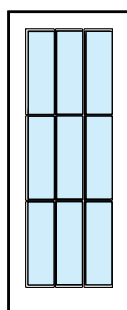

C C2000 (3w x 3h)
D D2000 (3w x 3h)

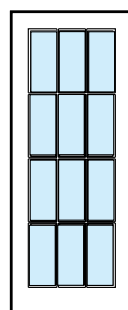

C C2000 (3w x 4h)
D D2000 (3w x 4h)

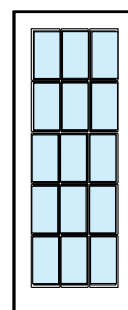

C C2000 (3w x 5h)
D D2000 (3w x 5h)

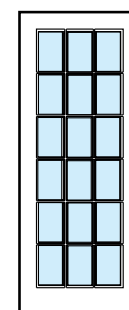

C C2000 (3w x 6h)
D D2000 (3w x 6h)

SQUARE TOP DOOR WITH SQUARE GLASS LAYOUTS

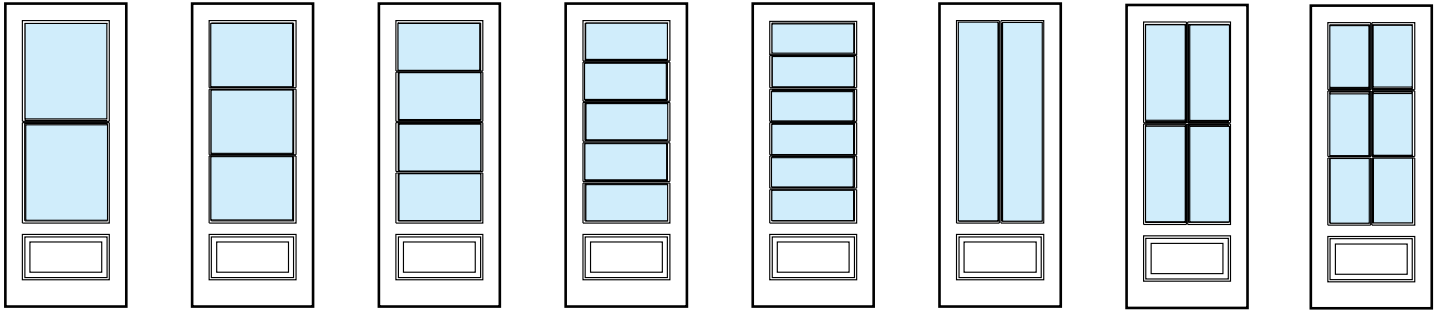

- C** C2090 (1w x 2h) **C** C2090 (1w x 3h) **C** C2090 (1w x 4h) **C** C2090 (1w x 5h) **C** C2090 (1w x 6h) **C** C2090 (2w x 1h) **C** C2090 (2w x 2h) **C** C2090 (2w x 3h)
- D** D2090 (1w x 2h) **D** D2090 (1w x 3h) **D** D2090 (1w x 4h) **D** D2090 (1w x 5h) **D** D2090 (1w x 6h) **D** D2090 (2w x 1h) **D** D2090 (2w x 2h) **D** D2090 (2w x 3h)

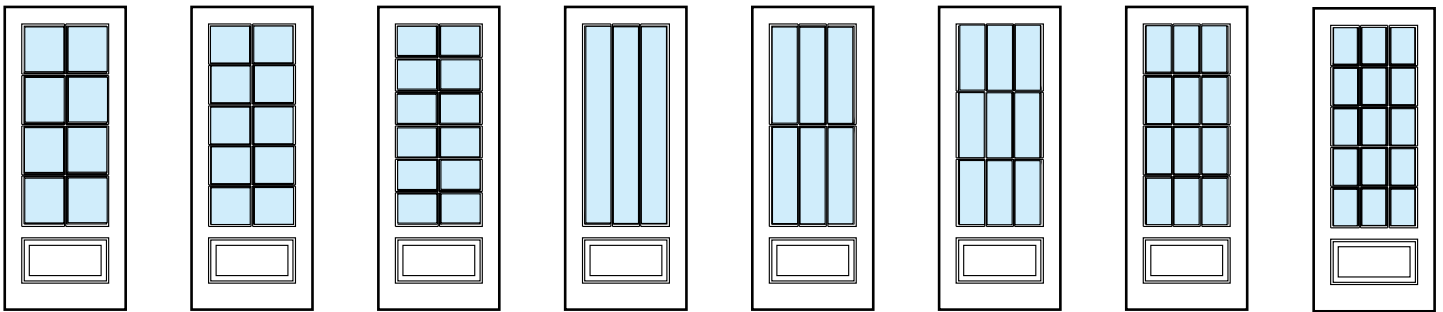

- C** C2090 (2w x 4h) **C** C2090 (2w x 5h) **C** C2090 (2w x 6h) **C** C2090 (3w x 1h) **C** C2090 (3w x 2h) **C** C2090 (3w x 3h) **C** C2090 (3w x 4h) **C** C2090 (3w x 5h)
- D** D2090 (2w x 4h) **D** D2090 (2w x 5h) **D** D2090 (2w x 6h) **D** D2090 (3w x 1h) **D** D2090 (3w x 2h) **D** D2090 (3w x 3h) **D** D2090 (3w x 4h) **D** D2090 (3w x 5h)

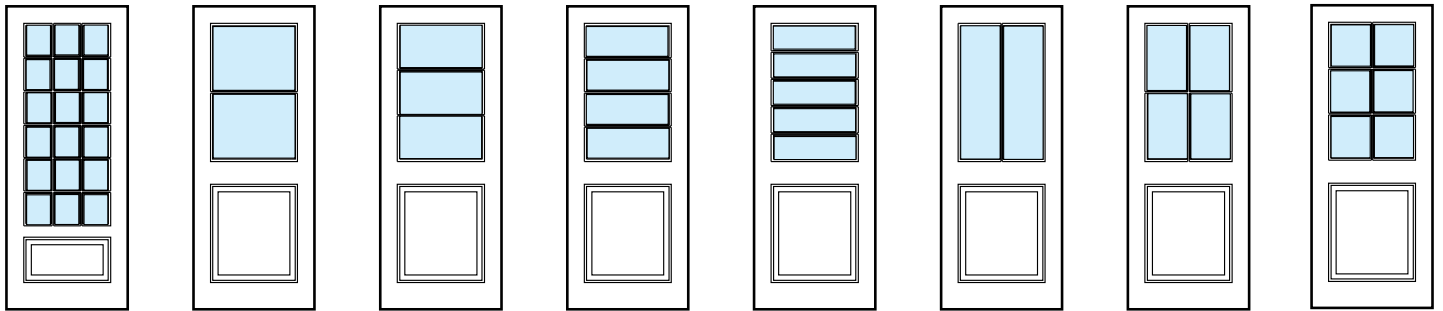

- C** C2090 (3w x 6h) **C** C2050 (1w x 2h) **C** C2050 (1w x 3h) **C** C2050 (1w x 4h) **C** C2050 (1w x 5h) **C** C2050 (2w x 1h) **C** C2050 (2w x 2h) **C** C2050 (2w x 3h)
- D** D2090 (3w x 6h) **D** D2050 (1w x 2h) **D** D2050 (1w x 3h) **D** D2050 (1w x 4h) **D** D2050 (1w x 5h) **D** D2050 (2w x 1h) **D** D2050 (2w x 2h) **D** D2050 (2w x 3h)

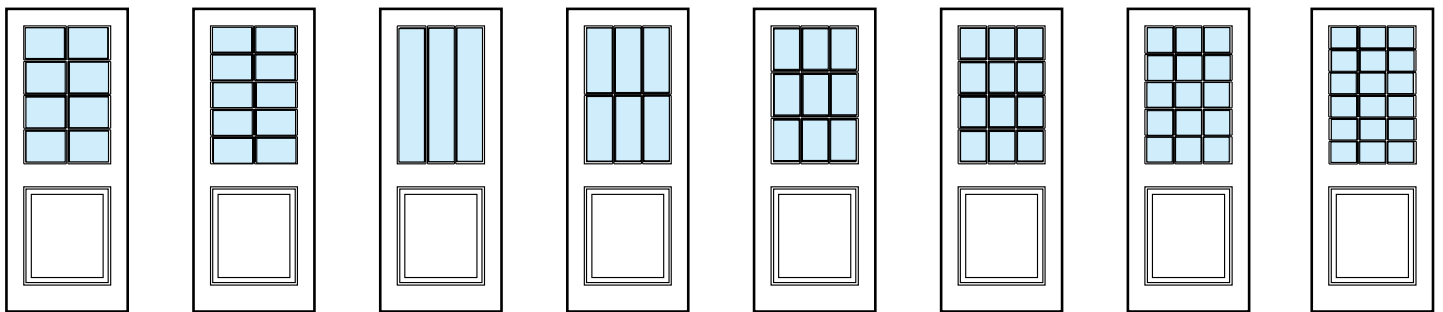

- C** C2050 (2w x 4h) **C** C2050 (2w x 5h) **C** C2050 (3w x 1h) **C** C2050 (3w x 2h) **C** C2050 (3w x 3h) **C** C2050 (3w x 4h) **C** C2050 (3w x 5h) **D** D2050 (3w x 6h)
- D** D2050 (2w x 4h) **D** D2050 (2w x 5h) **D** D2050 (3w x 1h) **D** D2050 (3w x 2h) **D** D2050 (3w x 3h) **D** D2050 (3w x 4h) **D** D2050 (3w x 5h)

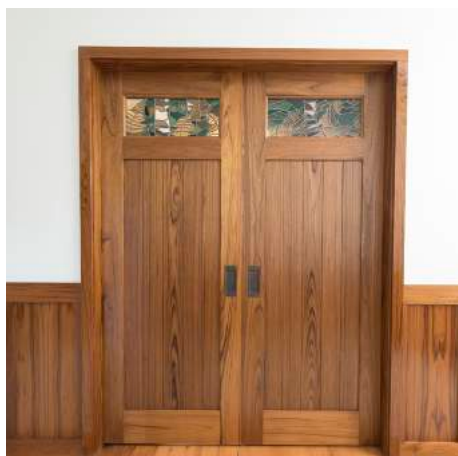
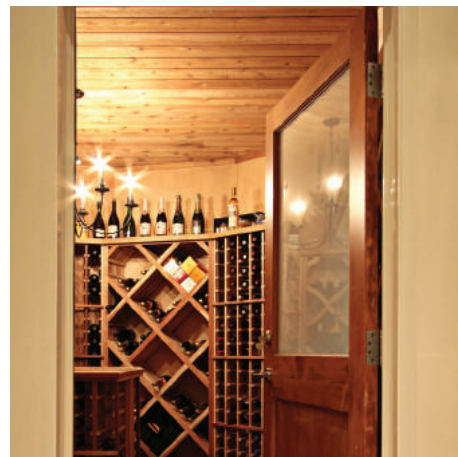

SQUARE TOP DOOR WITH SQUARE GLASS LAYOUTS

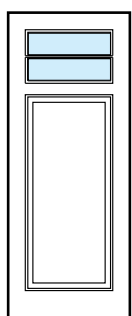

C C2560 (1w x 2h)
D D2560 (1w x 2h)

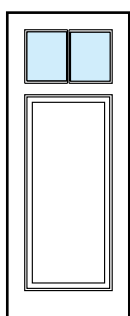

C C2560 (2w x 1h)
D D2560 (2w x 1h)

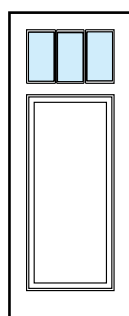

C C2560 (3w x 1h)
D D2560 (3w x 1h)

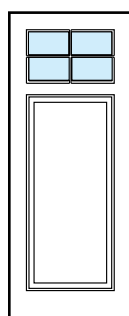

C C2560 (2w x 2h)
D D2560 (2w x 2h)

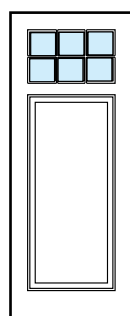

C C2560 (3w x 2h)
D D2560 (3w x 2h)

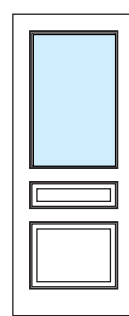

D D2240

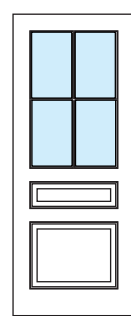

D D2240 (2w x 2h)

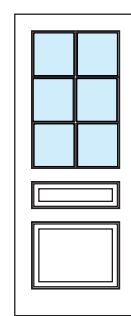

D D2240 (2w x 3h)

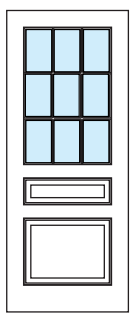

D D2240 (3w x 3h)

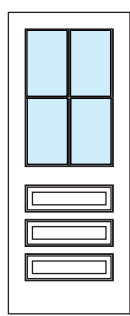

D D2370 (2w x 2h)

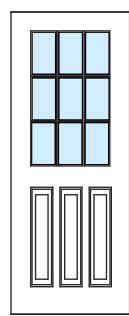

C C2590 (3w x 3h)
D D2590 (3w x 3h)

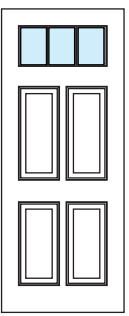

D D2440 (3w x 1h)

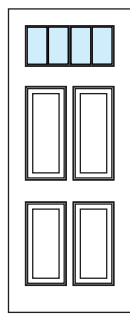

D D2440 (4w x 1h)

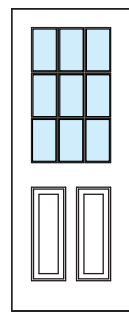

C D2070 (3w x 3h)
D D2070 (3w x 3h)

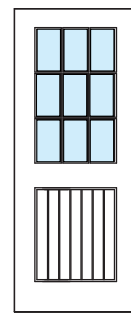

C D2071 (3w x 3h)
D D2071 (3w x 3h)

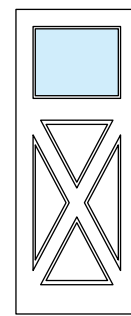

D D2180



SQUARE TOP DOOR WITH ARCHED GLASS LAYOUTS

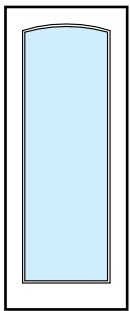

C C2000.1
D D2000.1

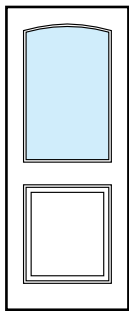

C C2050.1
D D2050.1

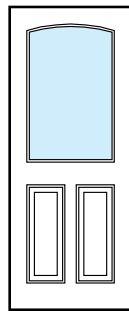

C C2070.1
D D2070.1

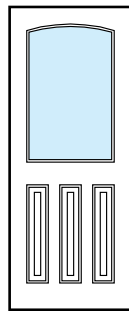

C C2590.1
D D2590.1

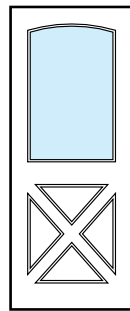

C C2080.1
D D2080.1

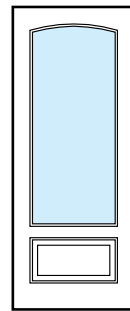

C C2090.1
D D2090.1

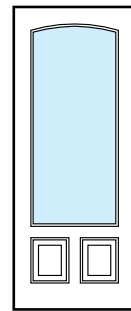

C C2600.1
D D2600.1

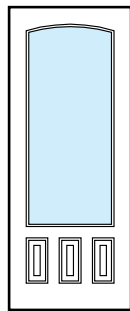

C C2610.1
D D2610.1

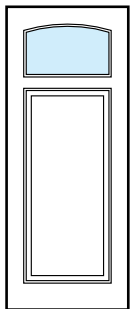

C C2560.1
D D2560.1

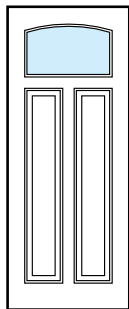

C C2110.1
D D2110.1

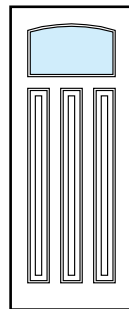

C C2140.1
D D2140.1

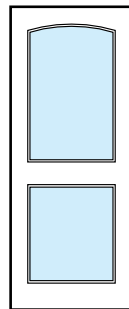

C C2160.1
D D2160.1

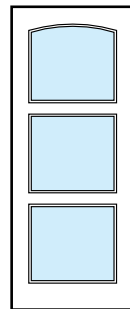

C C2170.1
D D2170.1

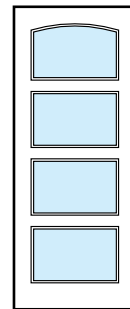

C C2190.1
D D2190.1

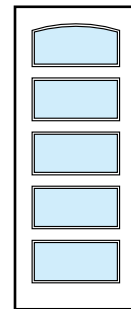

C C2230.1
D D2230.1

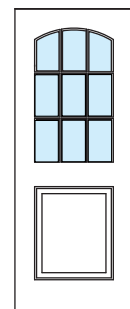

C D2051.1 (3w x 3h)
D D2051.1 (3w x 3h)

For questions, please call our door experts at 800-570-8283

ARCHED TOP DOOR WITH ARCHED GLASS LAYOUTS

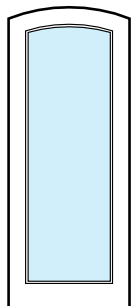

C C2000.2
D D2000.2

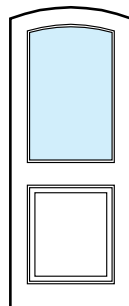

C C2050.2
D D2050.2

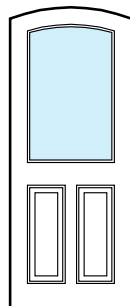

C C2070.2
D D2070.2

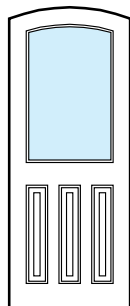

C C2590.2
D D2590.2

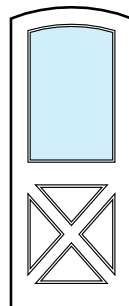

C C2080.2
D D2080.2

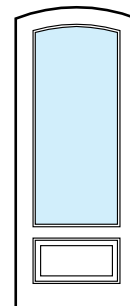

C C2090.2
D D2090.2

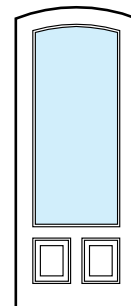

C C2600.2
D D2600.2

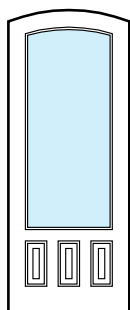

C C2610.2
D D2610.2

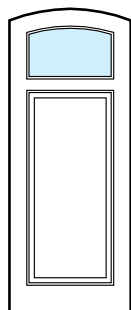

C C2560.2
D D2560.2

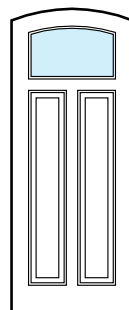

C C2110.2
D D2110.2

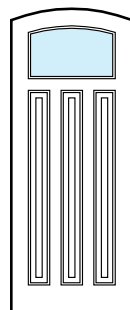

C C2140.2
D D2140.2

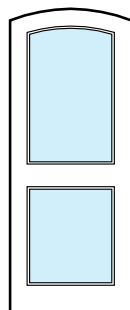

C C2160.2
D D2160.2

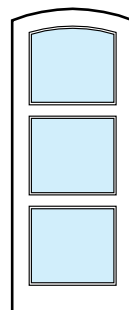

C C2170.2
D D2170.2

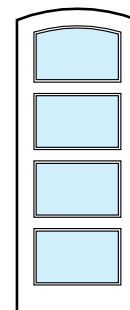

C C2190.2
D D2190.2

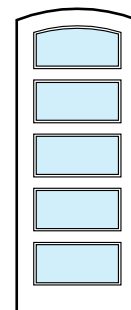

C C2230.2
D D2230.2

SQUARE TOP DOOR WITH RADIUS GLASS LAYOUTS

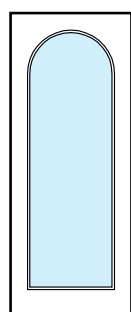

C C2000.3
D D2000.3

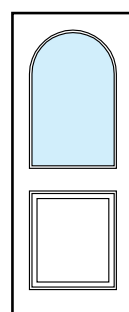

C C2050.3
D D2050.3

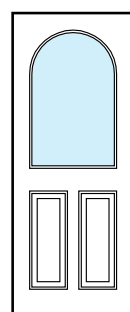

C C2070.3
D D2070.3

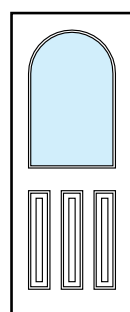

C C2590.3
D D2590.3

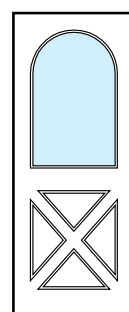

C C2080.3
D D2080.3

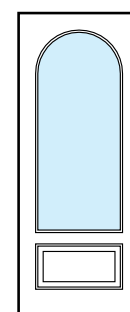

C C2090.3
D D2090.3

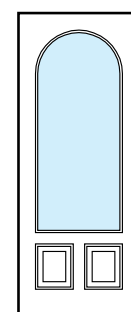

C C2600.3
D D2600.3

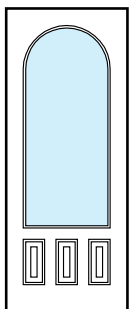

C C2610.3
D D2610.3

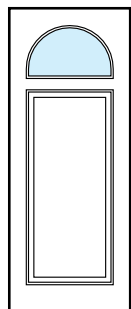

C C2560.3
D D2560.3

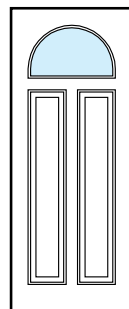

C C2110.3
D D2110.3

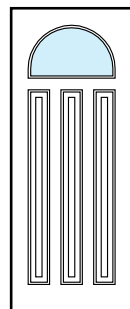

C C2140.3
D D2140.3

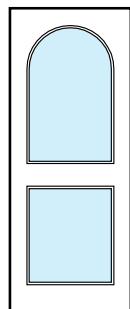

C C2160.3
D D2160.3

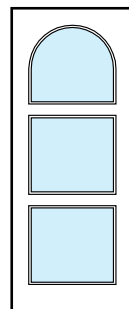

C C2170.3
D D2170.3

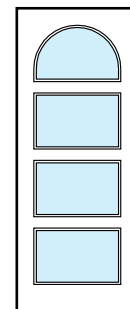

C C2190.3
D D2190.3

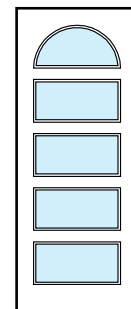

C C2230.3
D D2230.3

RADIUS TOP DOOR WITH RADIUS GLASS LAYOUTS

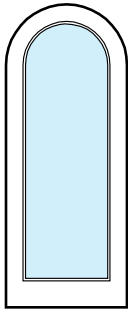

C C2000.4
D D2000.4

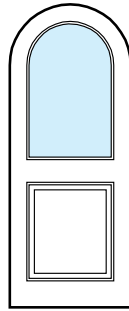

C C2050.4
D D2050.4

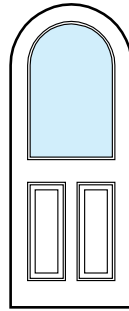

C C2070.4
D D2070.4

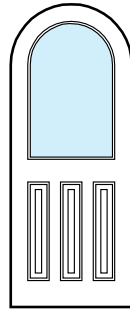

C C2590.4
D D2590.4

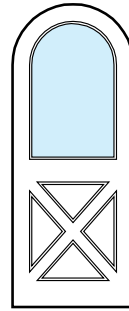

C C2080.4
D D2080.4

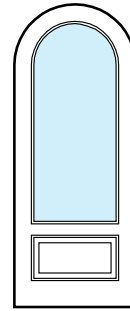

C C2090.4
D D2090.4

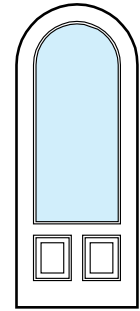

C C2600.4
D D2600.4

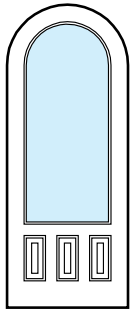

C C2610.4
D D2610.4

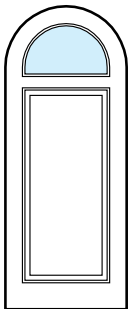

C C2560.4
D D2560.4

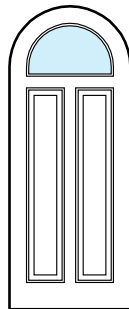

C C2110.4
D D2110.4

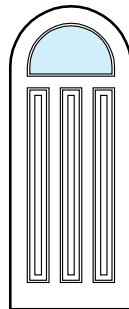

C C2140.4
D D2140.4

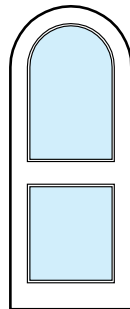

C C2160.4
D D2160.4

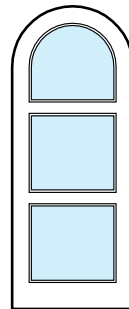

C C2170.4
D D2170.4

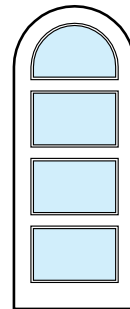

C C2190.4
D D2190.4

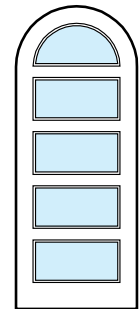

C C2230.4
D D2230.4

SQUARE TOP DOOR WITH FRENCH CURVE GLASS LAYOUTS

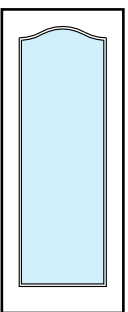

C C2000.5
D D2000.5

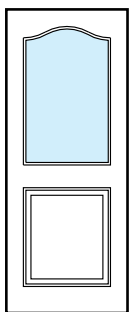

C C2050.5
D D2050.5

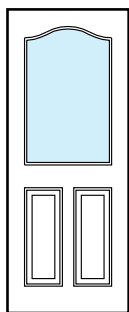

C C2070.5
D D2070.5

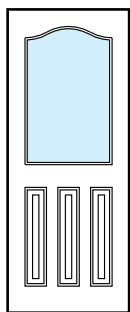

C C2590.5
D D2590.5

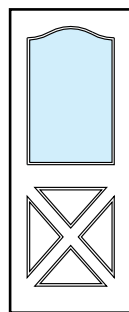

C C2080.5
D D2080.5

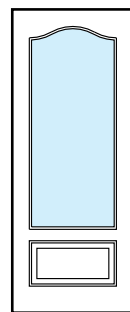

C C2090.5
D D2090.5

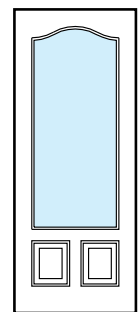

C C2600.5
D D2600.5

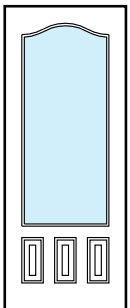

C C2610.5
D D2610.5

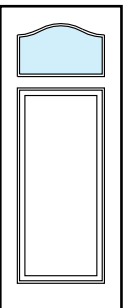

C C2560.5
D D2560.5

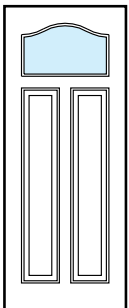

C C2110.5
D D2110.5

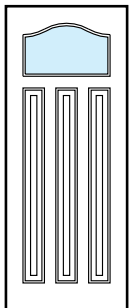

C C2140.5
D D2140.5

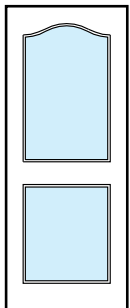

C C2160.5
D D2160.5

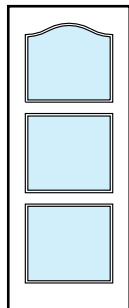

C C2170.5
D D2170.5

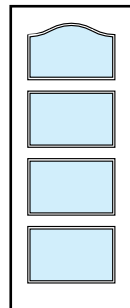

C C2190.5
D D2190.5

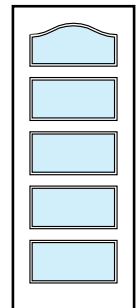

C C2230.5
D D2230.5

UNIQUE PANEL AND GLASS LAYOUTS

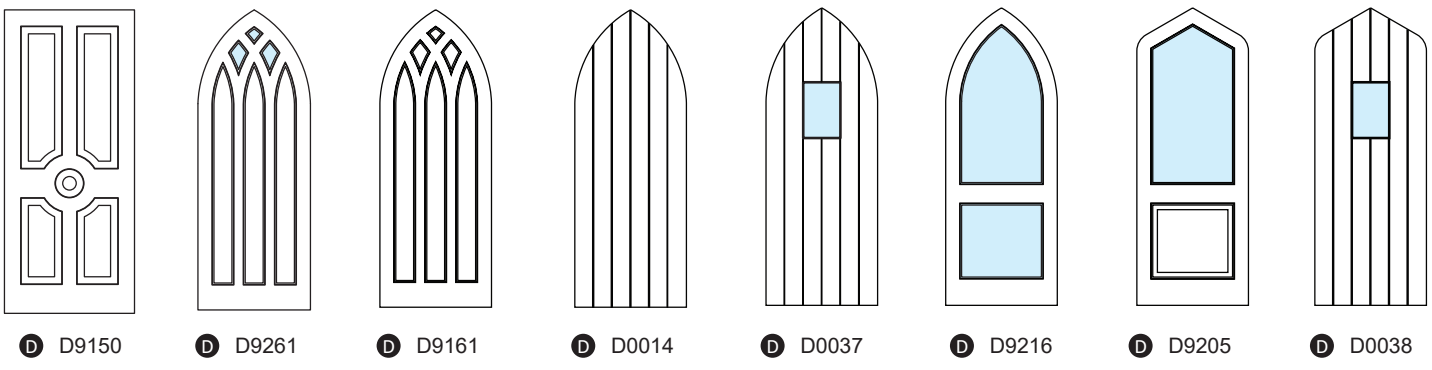
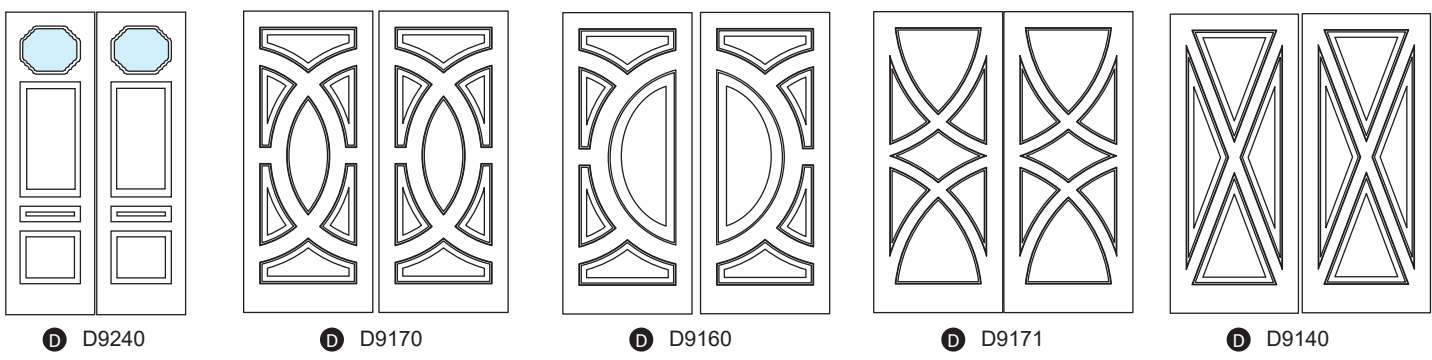
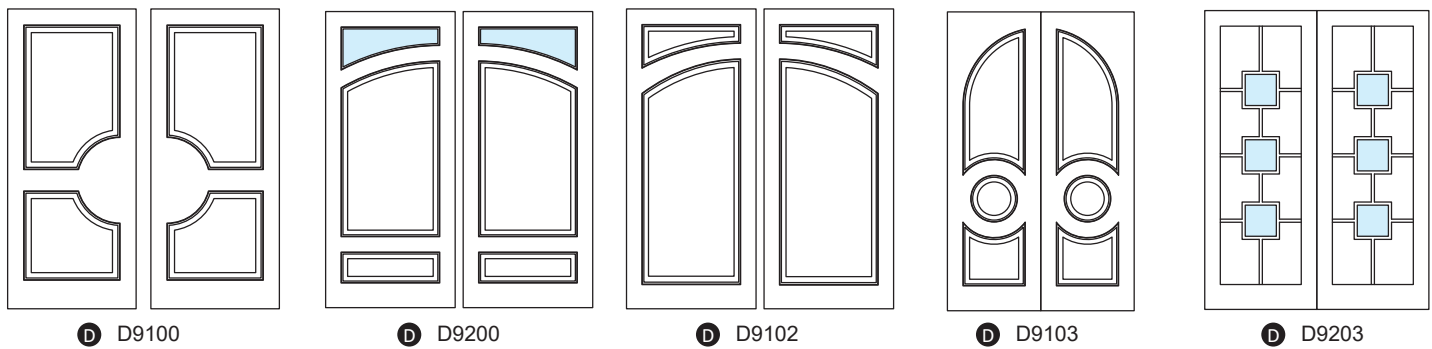

SPECIALTY HARDWARE LAYOUTS

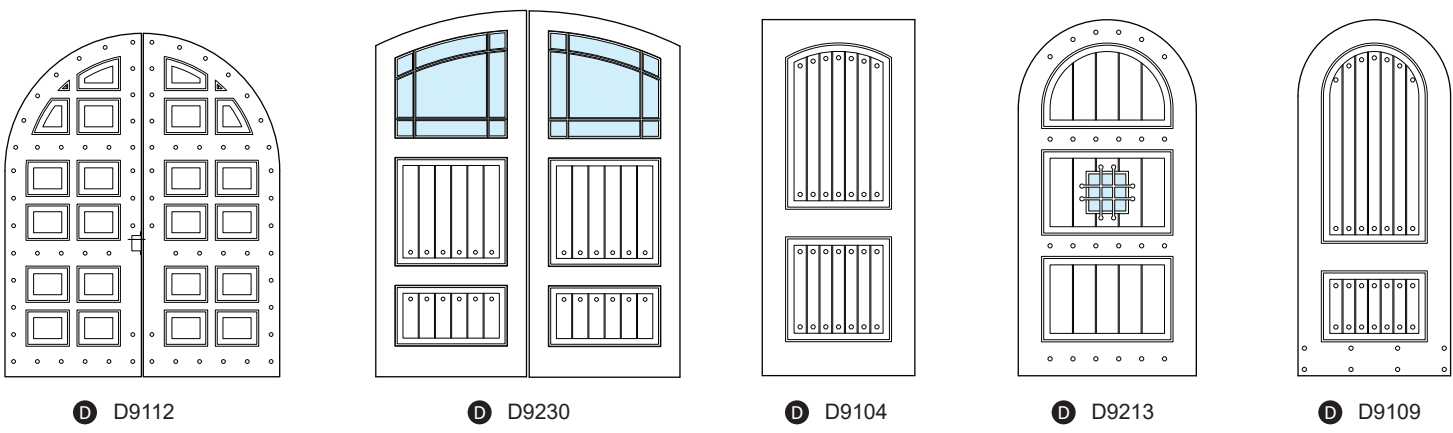

UNIQUE PANEL AND GLASS LAYOUTS

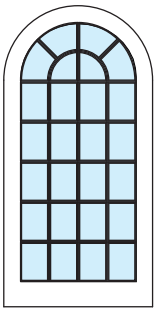

D D9204

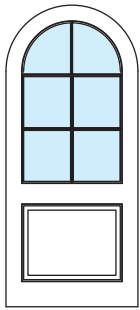

D D9221

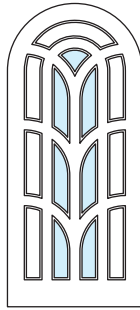

D D9214

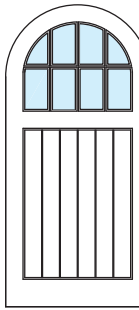

D D9201

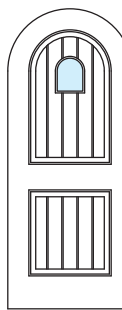

D D9202

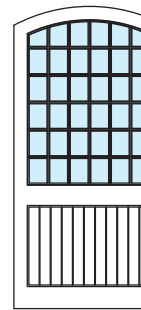

D D9235

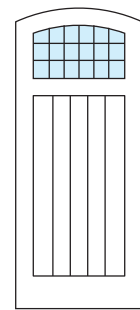

D D9236

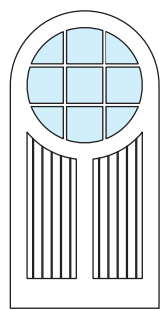

D D9242

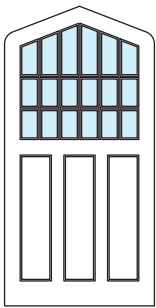

D D9237

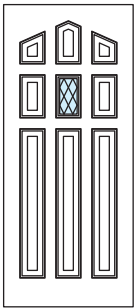

D D9209

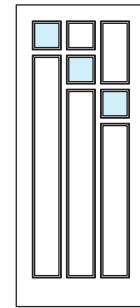

D D9208

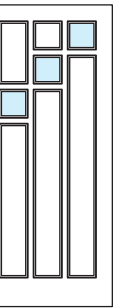

D D9208

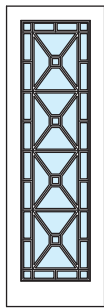

D D9294

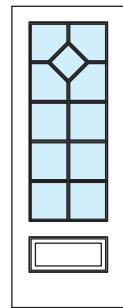

D D9281

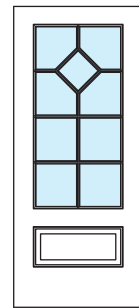

D D9282

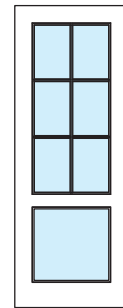

D D9277

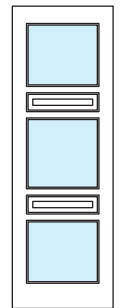

D D9232

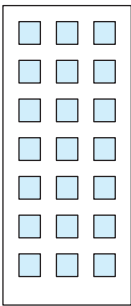

D D9273

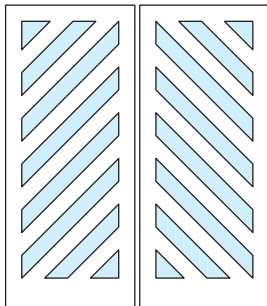

D D9245

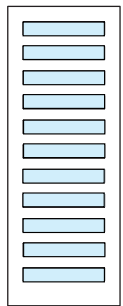

D D9211

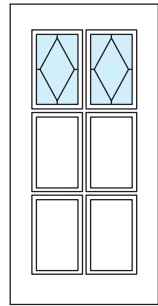

D D9248

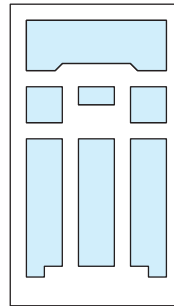

D D9278

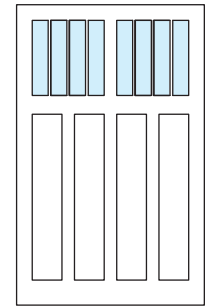

D D9263

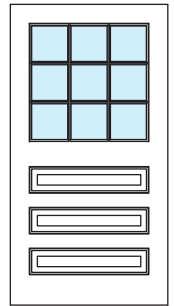

D D2370
(3w x 3h)

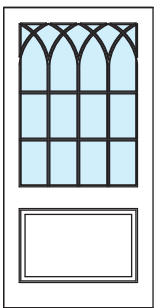

D D9238

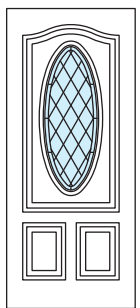

D D9241

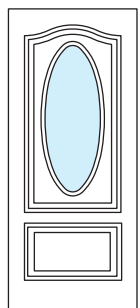

D D9231

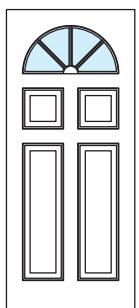

D D9254

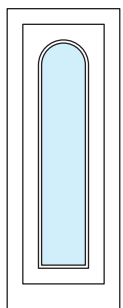

D D9290

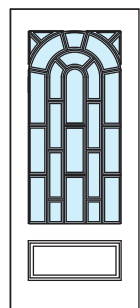

D D9299

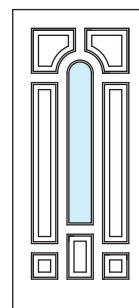

D D9291

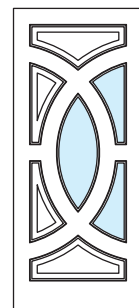

D D9270

For questions, please call our door experts at 800-570-8283

MULTI UNIT LAYOUTS

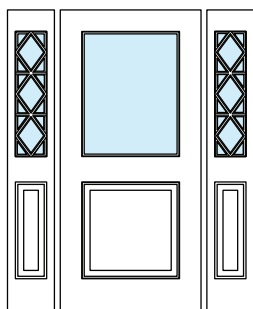

D MU1001

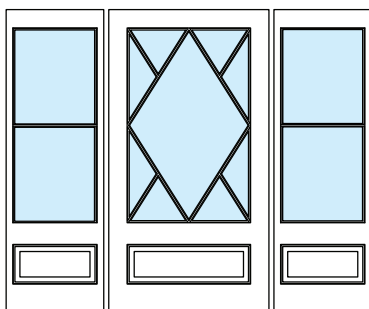

D MU1002

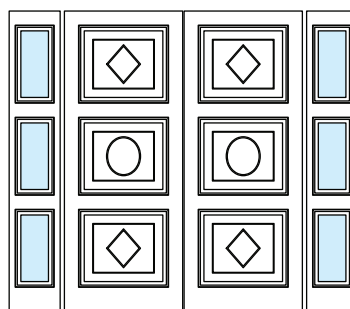

D MU1003

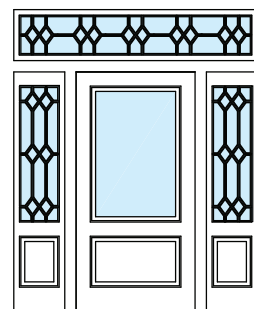

D MU1004

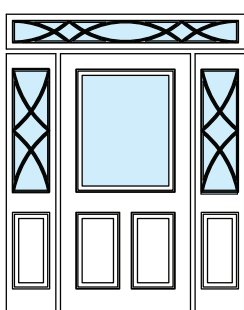

D MU1005

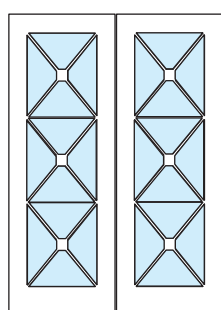

D MU1006

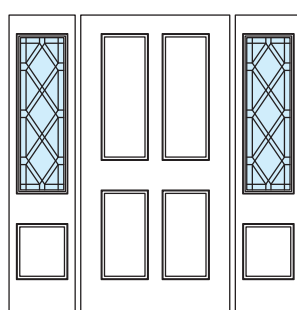

D MU1007

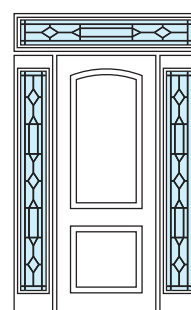

D MU1008

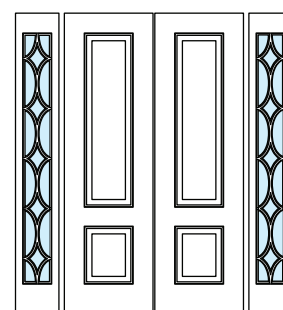

D MU1009

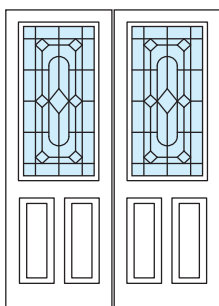

D MU1010

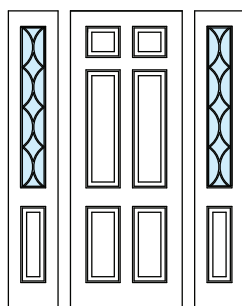

D MU1011

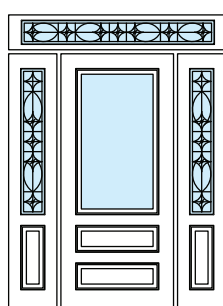

D MU1012

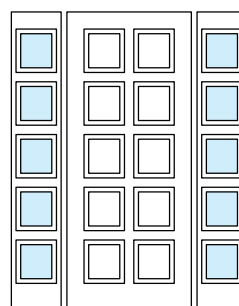

D MU1013



D MU1014

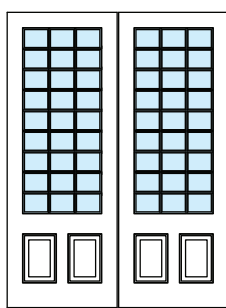

D MU1015

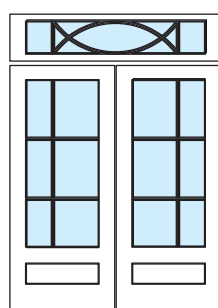

D MU1016

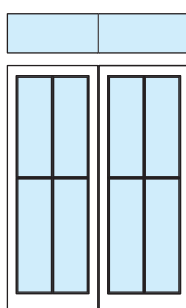

D MU1017

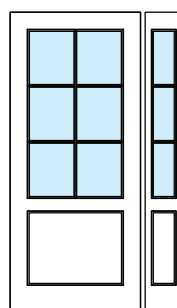

D MU1018

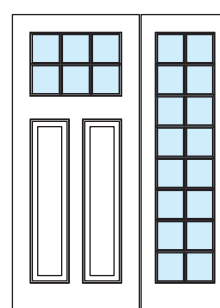

D MU1019

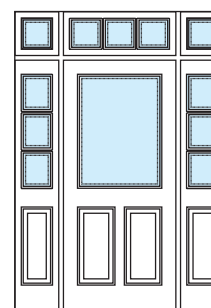

D MU1020

MULTI UNIT LAYOUTS

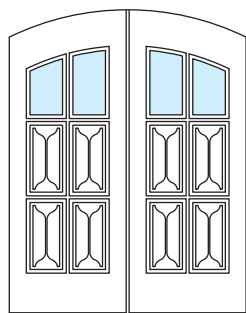

D MU1041

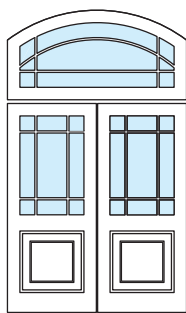

D MU1042

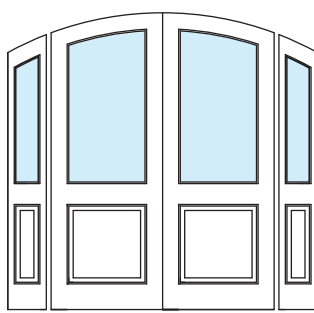

D MU1043

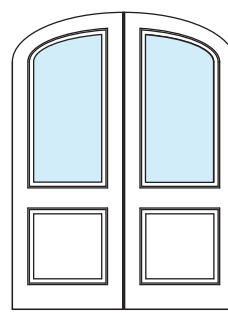

D MU1044

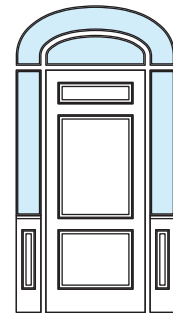

D MU1045

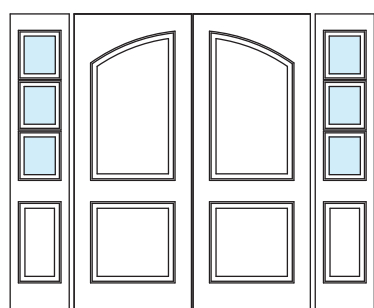

D MU1046

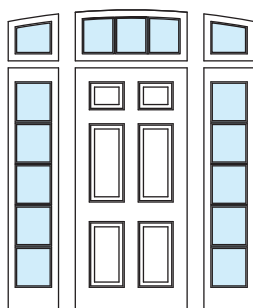

D MU1047



D MU1048



D MU1049

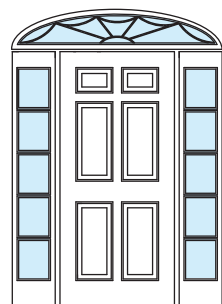

D MU1050



D MU1051

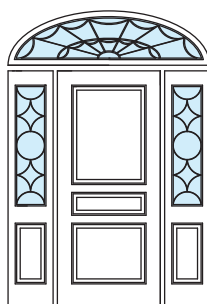

D MU1052

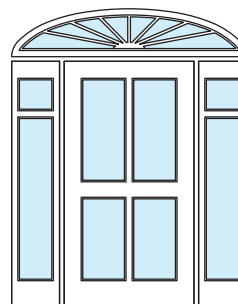

D MU1053

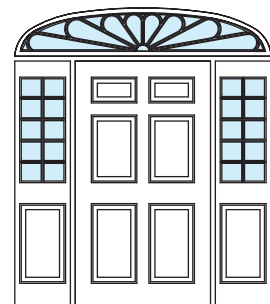

D MU1054

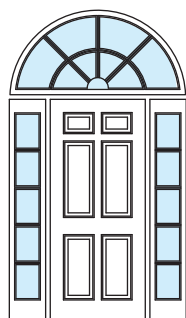

D MU1055

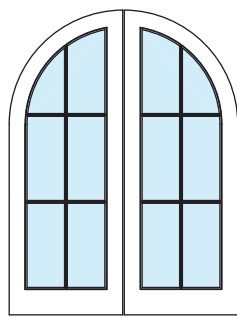

D MU1056

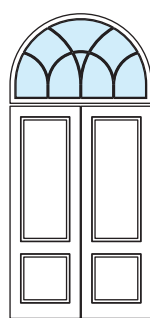

D MU1057



SIDELITE LAYOUTS

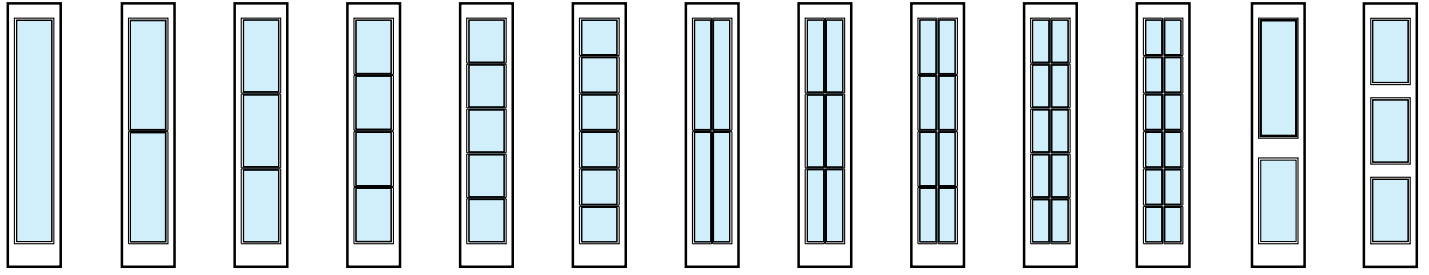

C C3000 (1w x 2h) (1w x 3h) (1w x 4h) (1w x 5h) (1w x 6h) (2w x 2h) (2w x 3h) (2w x 4h) (2w x 5h) (2w x 6h) **C** C3100 **C** C3110
D D3000 **D** D3100 **D** D3110

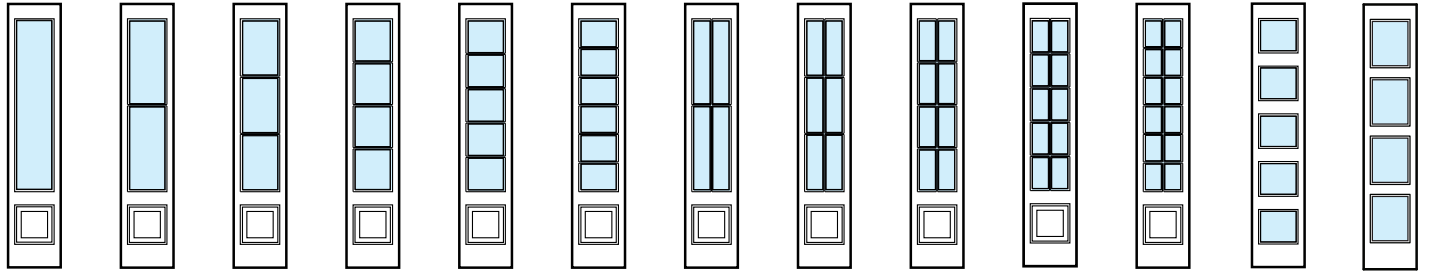

C C3010 (1w x 2h) (1w x 3h) (1w x 4h) (1w x 5h) (1w x 6h) (2w x 2h) (2w x 3h) (2w x 4h) (2w x 5h) (2w x 6h) **C** C3120 **C** C3130
D D3010 **D** D3120 **D** D3130

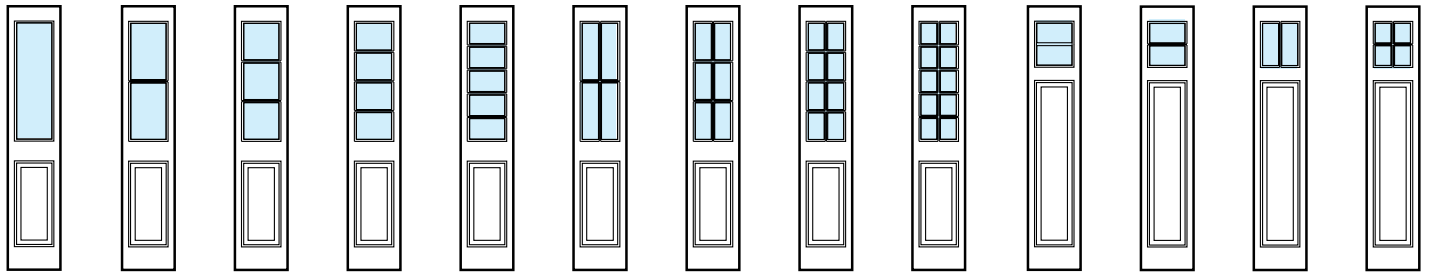

C C3020 (1w x 2h) (1w x 3h) (1w x 4h) (1w x 5h) (2w x 2h) (2w x 3h) (2w x 4h) (2w x 5h) **C** C3030 (1w x 2h) (2w x 1h) (2w x 2h)
D D3020 **D** D3030

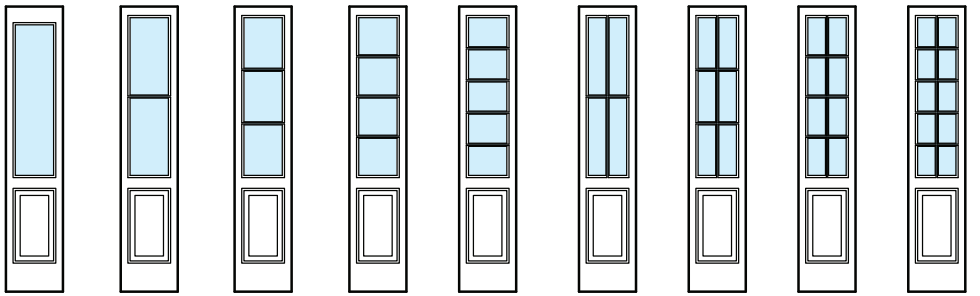

C C3040 (1w x 2h) (1w x 3h) (1w x 4h) (1w x 5h) (2w x 2h) (2w x 3h) (2w x 4h) (2w x 5h)
D D3040

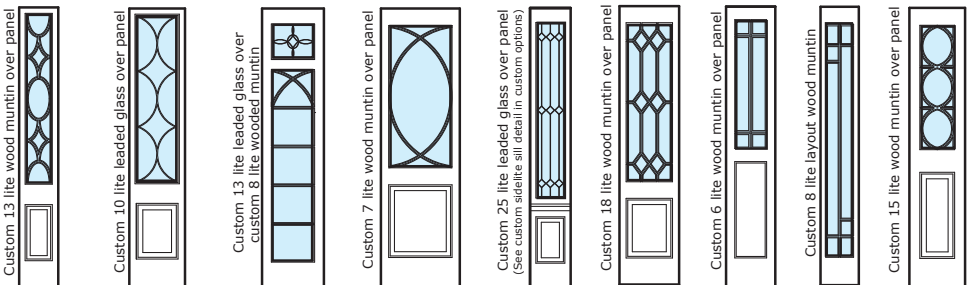

D D3213 Custom 13 lite wood muntin over panel
D D3210 Custom 10 lite leaded glass over panel
D D3221 Custom 13 lite leaded glass over custom 8 lite wood muntin
D D3207 Custom 7 lite wood muntin over panel
D D3225 Custom 25 lite leaded glass over panel (See custom sheets for details in custom options)
D D3218 Custom 18 lite wood muntin over panel
D D3206 Custom 6 lite wood muntin over panel
D D3208 Custom 8 lite layout wood muntin
D D3215 Custom 15 lite wood muntin over panel



TRANSOM LAYOUTS



- C** C4000 (Full Lite)
- D** D4000 (Full Lite)



- C** C4000 (2w x 1h)
- D** D4000 (2w x 1h)

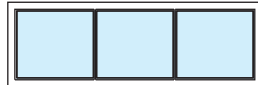

- C** C4000 (3w x 1h)
- D** D4000 (3w x 1h)



- C** C4000 (4w x 1h)
- D** D4000 (4w x 1h)



- C** C4000 (5w x 1h)
- D** D4000 (5w x 1h)

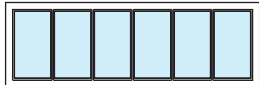

- C** C4000 (6w x 1h)
- D** D4000 (6w x 1h)

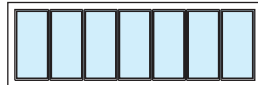

- C** C4000 (7w x 1h)
- D** D4000 (7w x 1h)



- C** C4000 (8w x 1h)
- D** D4000 (8w x 1h)



- C** C4000 (1w x 2h)
- D** D4000 (1w x 2h)



- C** C4000 (2w x 2h)
- D** D4000 (2w x 2h)

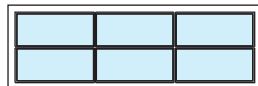

- C** C4000 (3w x 2h)
- D** D4000 (3w x 2h)

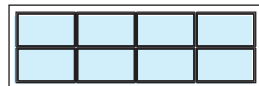

- C** C4000 (4w x 2h)
- D** D4000 (4w x 2h)



- C** C4000 (5w x 2h)
- D** D4000 (5w x 2h)



- C** C4000 6w x 2h)
- D** D4000 6w x 2h)



- C** C4000 (7w x 2h)
- D** D4000 (7w x 2h)



- C** C4000 (8w x 2h)
- D** D4000 (8w x 2h)



D D4021

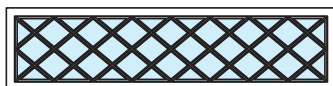

D D4042

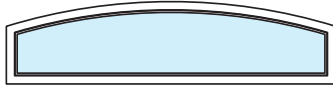

D D4001



D D4002

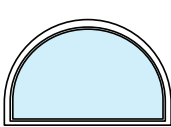

D D4003

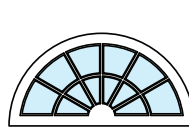

D D4012

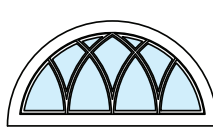

D D4009

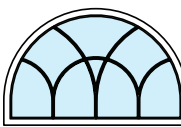

D D4008

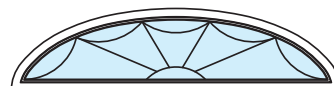

D D4011

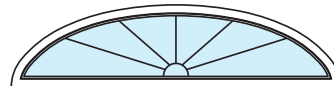

D D4007

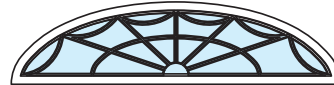

D D4018



D D4015

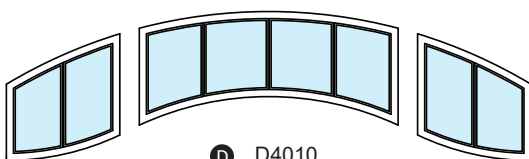

D D4010

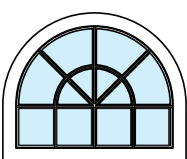

D D4013

Looking for something different? Contact us to discuss other options, or create your own design!







FLUSH DOORS

Utilizing a bonded solid core and lumber hand-selected by experienced workers, our flush doors come in custom sizes and are all available to be prehung. We offer specialized options, such as portholes, speak-easies, v-grooves and engineered core material.

Upstate Door offers flush doors in paint grade or stain grade for both your interior and exterior door needs. Each door is created with the following standard Upstate flush door features adding strength and durability, as well as, reducing the risk of delamination.

- Dado construction between the core and solid material
- Solid wood edge banding for stiles and rails
- Edge banding is doweled and glued at meeting stiles and rail joints
- Interior doors with a solid core (core material depends on application)
- Exterior doors with an LSL core, planks, and stave core to resist moisture and rot
- Matching edge & face wood species used throughout door
- Fibrex skin is used for interior paint grade flush doors

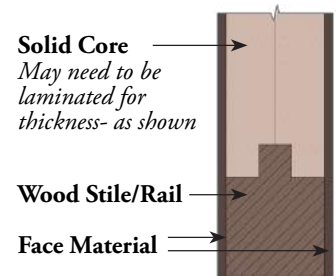

Both interior and exterior flush doors are warranted under Upstate Door's standard warranty guidelines.

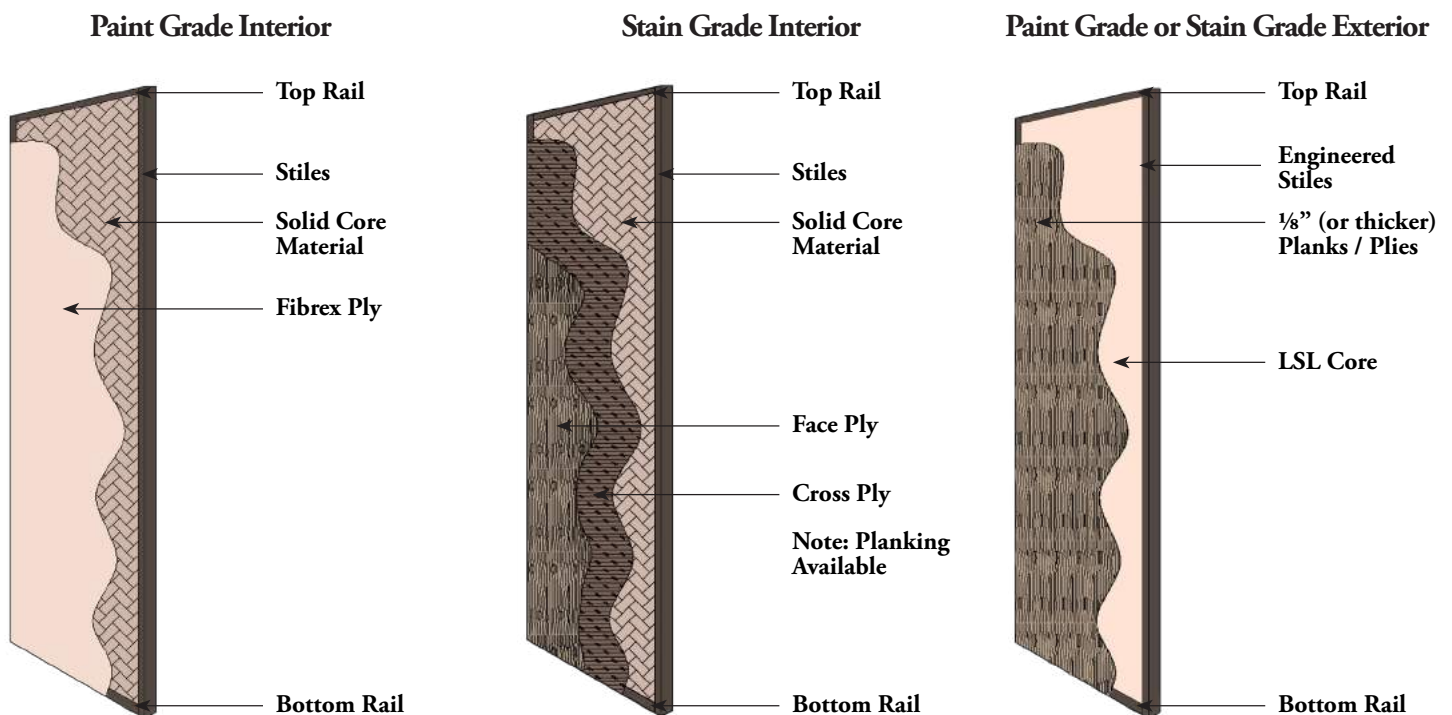

COMMON FLUSH DOOR LAYOUTS

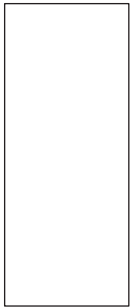

D D0001

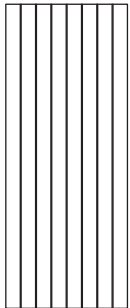

D D0002

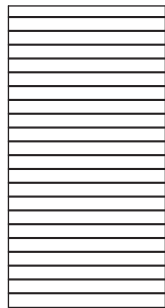

D D0003

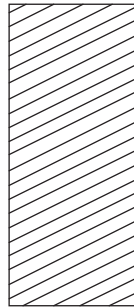

D D0004

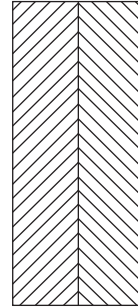

D D0005

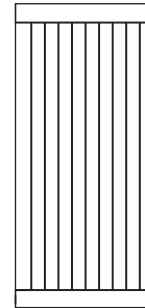

D D0006

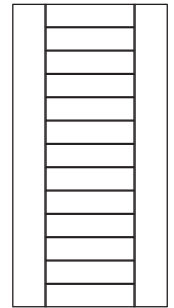

D D0007

CUSTOM FLUSH DOOR LAYOUTS

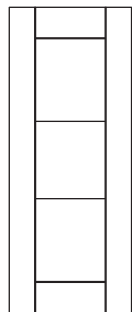

D D0008

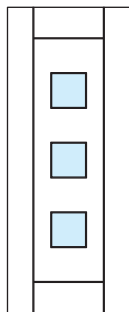

D D0021

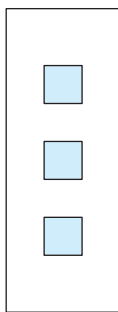

D D0023

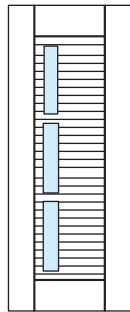

D D0022

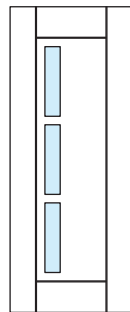

D D0024

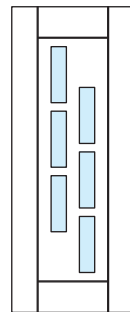

D D0026

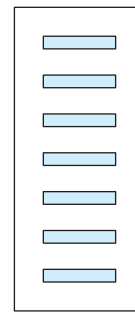

D D0027

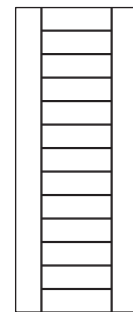

D D0007

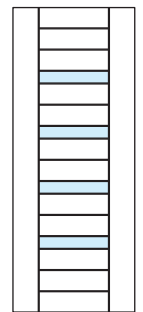

D D0025

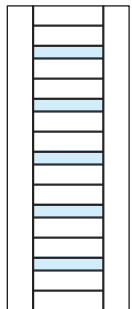

D D0028

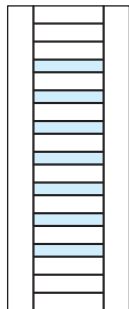

D D0029

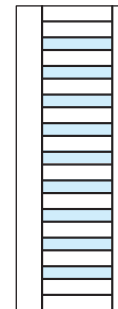

D D0030



D D0031

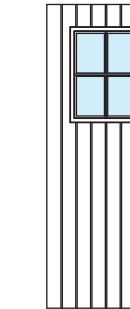

D D0032
(2w x 2h)

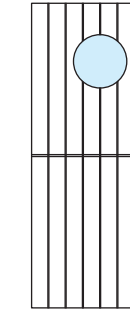

D D0033

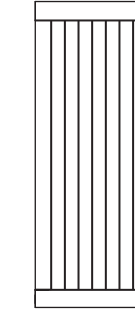

D D0006

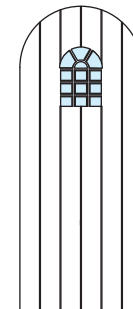

D D0034.4

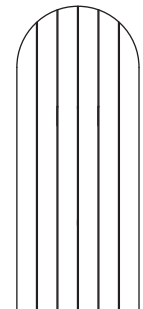

D D0002.4

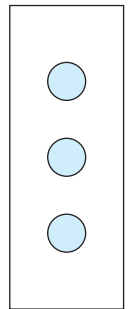

D D0035

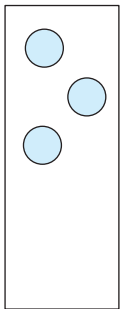

D D0036

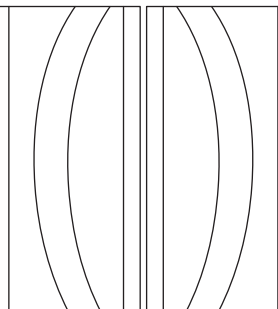

D D0009

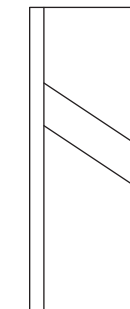

D D0010

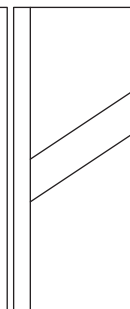

D D0010

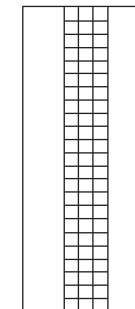

D D0011

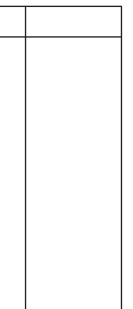

D D0012

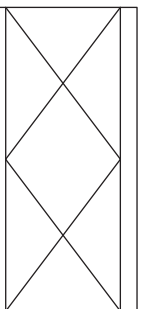

D D0013

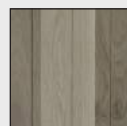

Talk to us about adding specialty glass, custom veneer, kerfs, or grooves to your design!





PIVOT DOORS

A pivot hung door swings on a set of pins mounted to the floor and head jamb, and in the top and bottom of the door. This offers a seamless transition from the door to the wall, highlighting clean lines and modern architecture.

Interior pivot doors are typically used in kitchen applications for convenience and functionality. Exterior pivot doors are preferred in modern and contemporary style homes. For exterior applications, offset pivot doors are a viable solution.

All doors are built completely to your specifications. Our team of knowledgeable sales people and engineers provide excellent attention to detail and offer construction advice to ensure the door will work perfectly in each specialty application.

Contact us to help determine which hardware is best for your door!



Offset Pivot Hinges
Shown in Stainless Steel

D



Center Pivot Hinges
Shown in Stainless Steel

D





OVERSIZED DOORS: CARRIAGE + BARN DOORS

We can easily accommodate unusual or unique sizes and shapes, which makes us a perfect partner for distinctive oversized doors.

We know that oversized doors need extra attention and we offer solutions to make them structurally sound. We offer custom oversized panel, glass, or flush doors: if you can dream it, we can come up with a way to make it.

Standards include:

- Engineered cores, stiles, and rails to limit movement
- The right hardware for your specific application to reduce warpage or sagging
- A custom door built to your specifications
- An opportunity for you to speak directly with our engineers so we know exactly what you're looking for

Oversized door options include:

- Barn doors
- Exterior pivot doors
- Carriage doors
- Flush doors



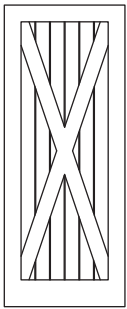

D D5102

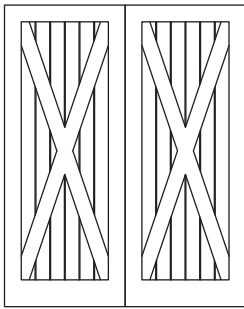

D D5104

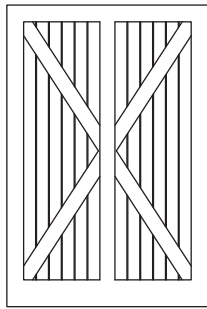

D D5105

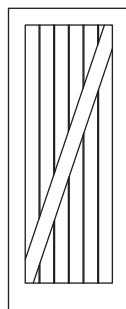

D D5101

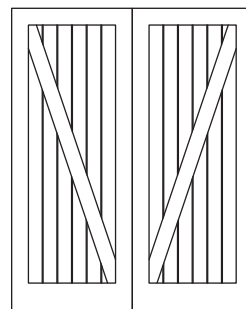

D D5103

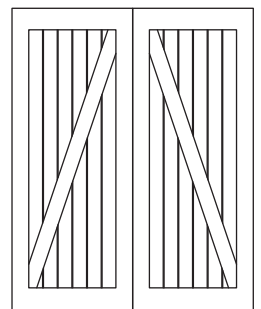

D D5106

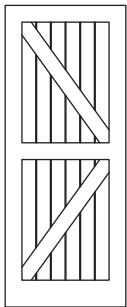

D D5202

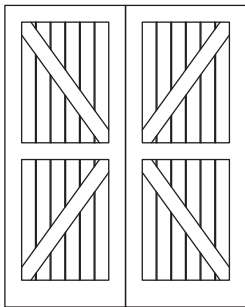

D D5204

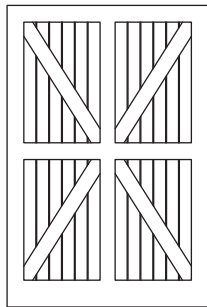

D D5206

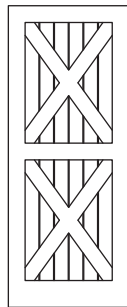

D D5208

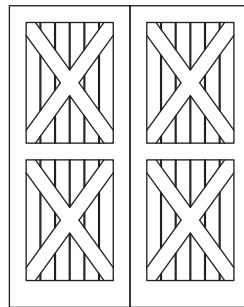

D D5216

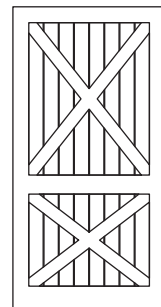

D D5209

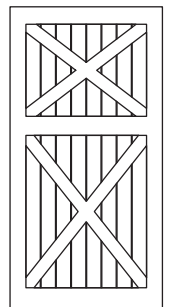

D D5218

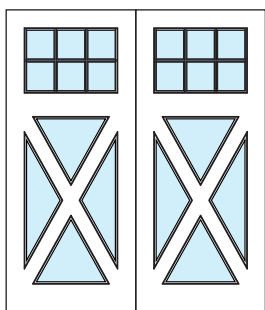

D D2710
(3w x 2h)

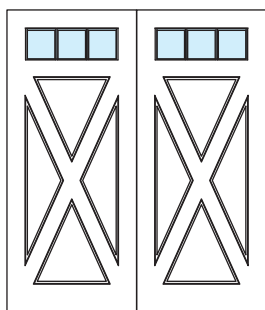

D D2700
(3w x 1h)

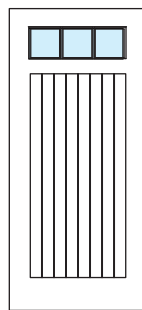

D D2122
(3w x 1h)

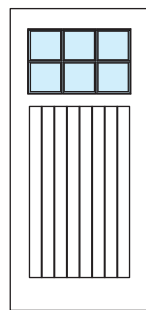

D D2123
(3w x 2h)

Don't see what you're looking for? Contact our experts with your own layout!





SCREEN/STORM COMBINATIONS + SCREEN DOORS

Enhance and protect your home's entry with Upstate Door's wood screen and screen/storm door options. All doors can be completely customized to match any design without compromising quality and durability. The glass and screens are easily interchangeable and can protect against the elements or let the fresh air breeze through.

| | | | | | | | | |
|--|----------------------------------|----------------------------------|----------------------------------|----------------------------------|--------------------------------------|------------------|-----------------|------------------------|
| Screen or Storm Options | | | | | | | | |
| | C C7000 D D7000 | C C7010 D D7010 | C C7020 D D7020 | C C7030 D D7030 | C C7000.2 D D7000.2 | D D7000.4 | D 7000.6 | Standard Dado Profile |
| Screen Only Options <small>(Storms Available)</small> | | | | | | | | |
| | C C6000 D D6000 | C C6010 D D6010 | C C6020 D D6020 | C C6030 D D6030 | C C6000.2 D D6000.2 | D D6000.4 | D 6000.6 | Standard Ovolo Profile |

D Available Under Distinctive Line

C Available Under Classics Line

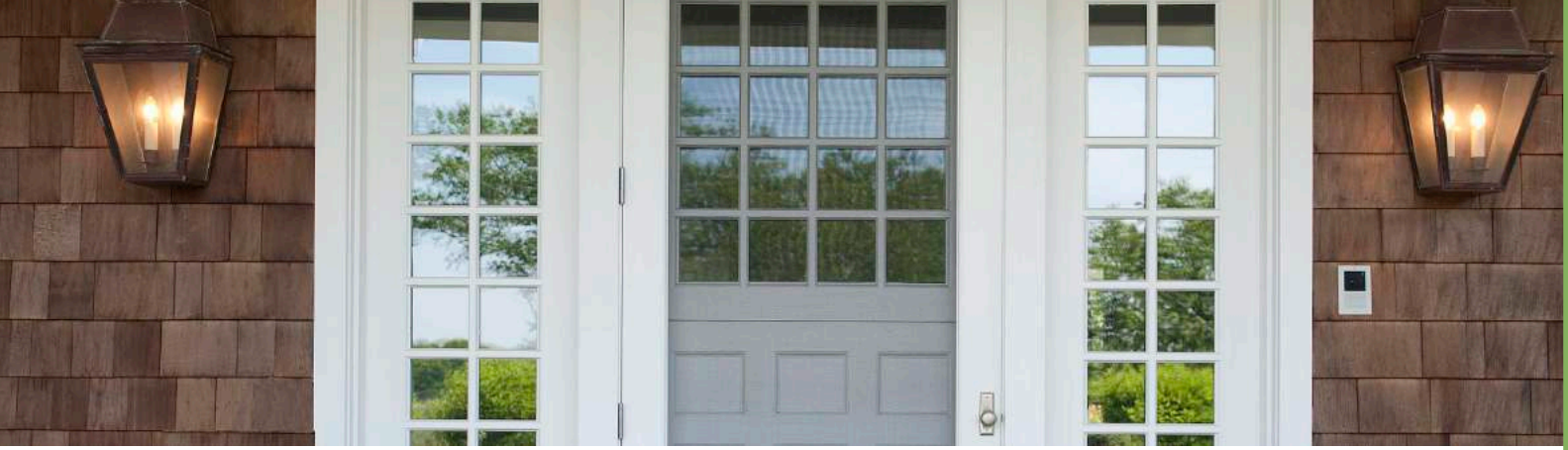

SCREEN/STORM HARDWARE

We use specialty hardware on our screen/storm doors to ensure proper engagement between the sash and door.



Screen/storm panel removal

Choose from a variety of Emtek or Baldwin hardware to complete the look and functionality of your custom screen/storm door. Both are made with the finest materials and complement our doors. Ask your door expert about the assortment of finish options available!



SCREEN OPTIONS

Let us help you decide which screen is the best for your application! Ask us about retractable screen systems for screening large openings!

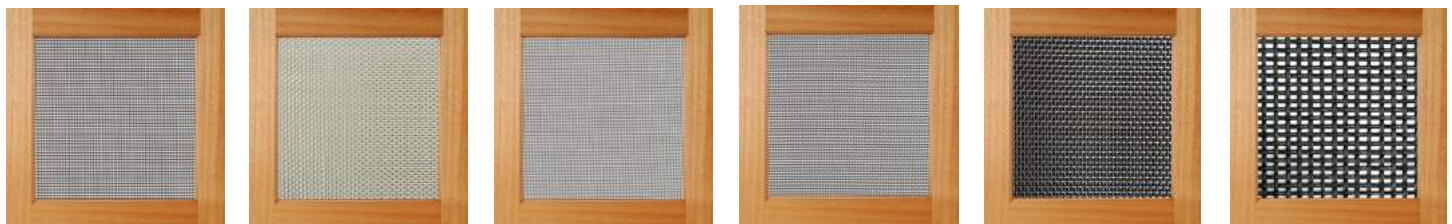

Charcoal Fiberglass
D C

Bronze Wire
D C

High Visibility
D C

Charcoal Aluminum
D C

Black Stainless Steel
D

Pet
D

D Available Under Distinctive Line C Available Under Classics Line

For questions, please call our door experts at 800-570-8283



Intricate

COASTAL DOORS

Why compromise elegance for function when you can have both? Upstate Door offers fine wood door solutions specifically designed for coastal areas. We can help you get the sophistication and style of a wood door in an area with high winds, water, and humidity and still have it look like the day you received it.



The minimum door thickness for coastal applications is 2 ¼”



Solid rails eliminate the possibility of delamination



Marine epoxy is used to glue the joints, reducing joint movement



Engineered drip and rain caps are included to help push water away from the unit



Multipoint hardware helps protect the door from high winds and water infiltration



Blockade sills are required because they help drain water away from the door



Additional weatherstripping is used to help keep water away from the unit



Stainless steel screws and hardware will not rust when exposed to the elements

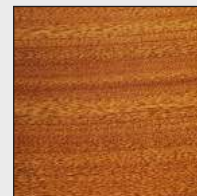

Mahogany wood is preferred because it is durable and more resistant to extreme weather



Factory finishing is encouraged to protect hard to reach areas and ensure the entire door is sealed



Homes built in coastal areas are exposed to extreme weather conditions that will take years off the life of a lower quality door. Let Upstate Door meet these challenges and provide a door that will exceed your coastal expectations!

COASTAL UPGRADE OPTIONS

Water Shield Sill Differences:



Stepped wooden sill crafted out of multiple pieces



Curved wooden nose helps drain water off while keeping the architectural detail



The sill is shimmed up 3/16" in the field to help water drain underneath the nose

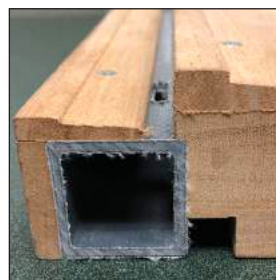

Water drains through holes into a composite channel under the sill



Upgraded Infiltration Options:



1/2" x 1/2" notched detail around the exterior door with two sets of 360° weatherstripping



Ability to use a regular handleset with multipoint hardware and a screen/storm door handleset

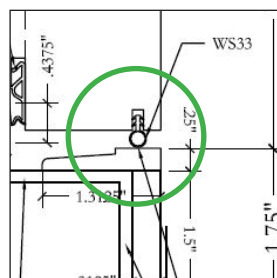

Additional set of weatherstripping along the bottom of the backside of the door keeps any other water out

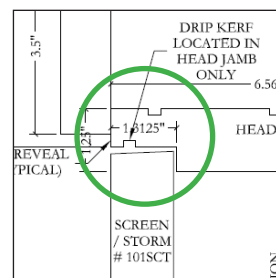

Drip kerf and beveled screen/storm to drain water off of the screen/storm door



For questions, please call our door experts at 800-570-8283



IMPACT RATED DOORS

Our Distinctive Exterior Custom Door Solutions are available to meet your building code requirements for home safety and greater property protections in hurricane-prone areas. Our doors are built for coastal environments and are resistant to a Category 3 hurricane, with sustained winds up to 129 mph. The minimum thickness for each impact rated door is 2 1/4”.

WIND
ZONE:

3

MISSILE
LEVEL:

D

IMPACT
GLASS



DP 50 & 75

CERTIFIED
BY:

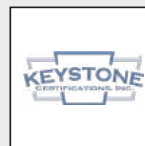

DP
OPTIONS
AVAILABLE



DP 30, 45,
50 & 75

WATER
RATED
OPTIONS
AVAILABLE





FIRE RATED DOORS

Traditional metal fire doors are unattractive, taking away from the architectural design and elegance of your home. Our custom hardwood fire doors will not only safeguard your home but will also add to its style.

Available in countless custom layouts, all of our fire doors are available with the following solutions:

- FyreWerks core for all doors and wood jambs
- 20, 45, 60 and 90 minute door ratings
- 20, 45, 60 and 90 minute jamb ratings
- Paint grade or stain grade doors and jambs
- Wood or metal jamb options (some restrictions apply)
- Flat or rabbeted jambs
- Flat or raised panels
- Minimum 1 ¾" door thickness
- Single bore, double bore or mortise
- Custom machining available for concealed vertical rods (not available in 90 minute), concealed auto closers (in 20 minute only), auto door bottoms, flush bolts and peep holes
- Doors must fit within testing specifications. Please call us for more information.

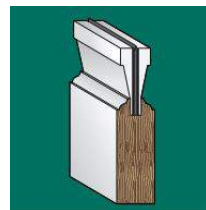

20 Minute

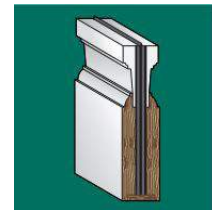

45-60 Minute



90 Minute



Custom

BIFOLD DOORS

All Upstate Door bifolding units are completely customizable to your design needs and will last for years to come. We can create interior or exterior doors in many different layouts and configurations ranging from two to sixteen doors.

- Up to 47" individual door width and 129" individual door height
- Minimum 1¾" door thickness
- Custom head jamb to accommodate hardware
- 220 lb maximum weight per door
- Up to 16 door layout (8 left + 8 right)
- Screen applications are also available on bifolding units up to 24' wide and 10' high
- Doors can fold to the interior or the exterior
- Warranty restrictions apply

Common Layouts:



2-O

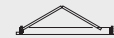

2-I



3-O



3-I



2+2-O



2+2-I



5-O

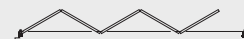

5-I



7-O

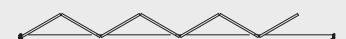

7-I



SLIDING DOORS

For indoor/outdoor living enjoyment, a custom hardwood lift and slide door is the perfect combination of visual appeal, function, and quality. Every sliding door is manufactured using Upstate Door's standard construction as well as:

- Lift locking mechanism
- Dual weather seals around the perimeter of each door
- Insulated safety glass
- Wood sill
- Minimum 2 ¼" door thickness
- Aluminum or black guide finish
- Wood screen/storm sliding door available to complement your slide door
- Uni-directional or bi-parting configurations



Scheme A

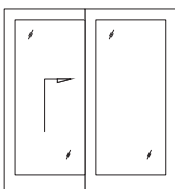

Scheme A-A

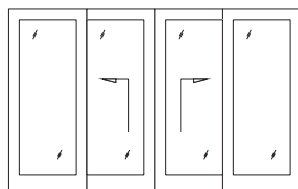

Scheme B

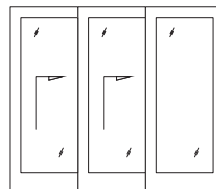

Scheme B-B

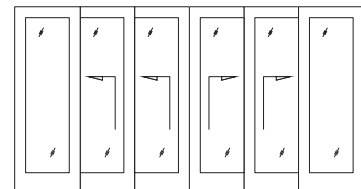

For questions, please call our door experts at 800-570-8283



LOUVER DOORS

Louver doors are charming interior doors with shutter-like slats that are perfect for rooms that need airflow, such as closets, laundry rooms, or rooms with digital equipment. Louver doors also work well in some exterior applications, such as in a pool house.

Create your own louver door by adding slats to any layout to match the rest of the doors in the home.

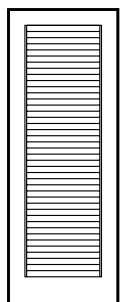

C C8000
D D8000

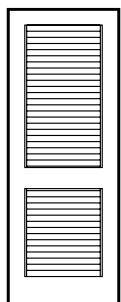

C C8010
D D8010

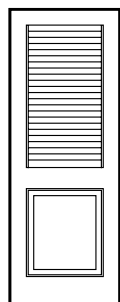

C C8020
D D8020

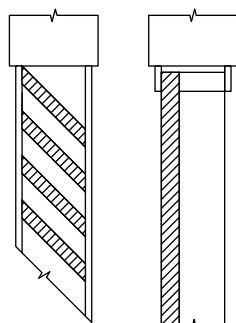

Standard Louver Profile

D **C**

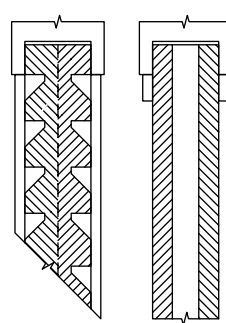

Chevron Louver Profile

D





DUTCH DOORS

A Dutch door is a two-piece door that offers flexibility of design. The top and bottom portions can be opened together or independently of each other. Our Dutch doors differ greatly from the competition because most manufacturers simply cut a door in half and call it a Dutch door. We create two separate smaller sized doors and fit them together in the jamb. This allows you to adjust the middle rail to accommodate where you want the handle to be. The top can also be visually different from the bottom.

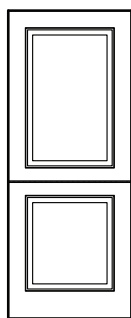
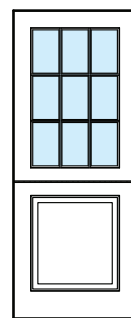
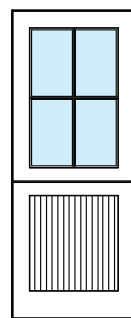
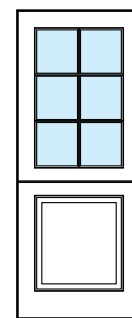
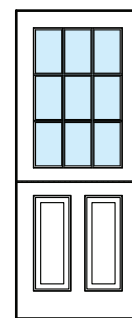
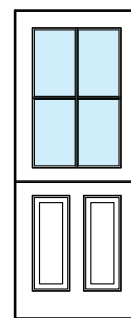
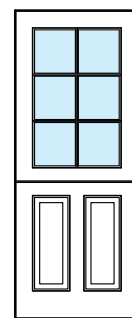
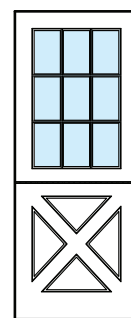
| | | | | | | | |
|--|---|---|---|---|---|---|---|
|  |  |  |  |  |  |  |  |
| D D1040 | D D2050 (3w x 3h) | D D2050 (2w x 2h) | D D2050 (2w x 3h) | D D2070 (3w x 3h) | D D2070 (2w x 2h) | D D2070 (2w x 3h) | D D2080 (3w x 3h) |

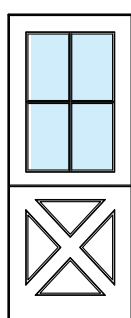
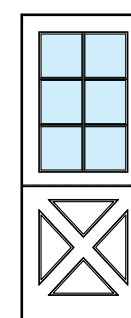
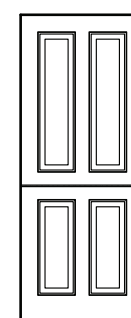
| | | |
|--|---|---|
|  |  |  |
| D D2080 (2w x 2h) | D D2080 (2w x 3h) | D D1280 |



Quadrant hardware holds both halves of a Dutch door together. These are available in a variety of finishes to match your door hardware.



We offer custom shelf details, half lap and ship lap details to compensate for exterior weatherstripping





CLIPPED CORNER DOORS

Clipped corner doors are the perfect solution to accommodate rooms with angled ceilings, such as an attic or under stairs. Virtually any layout can be modified to become a clipped corner door.

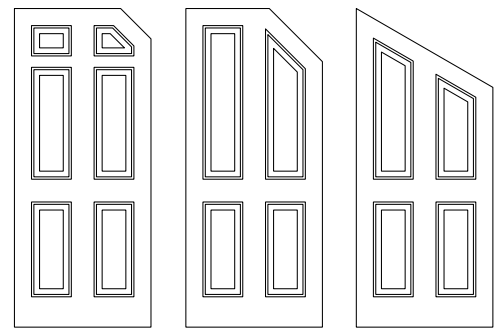

POCKET DOORS

Pocket doors are a great way to showcase architectural detail in a room where you're looking to save some space. These doors are a great solution for closets or bathrooms where there isn't enough room to open and close a full swinging door. Another option is to use them to partition one room from another to offer added privacy.

MIRACLE DOORS



The Miracle Door is a historic door design that originated in the 1920s. The elegant door-within-a-door design was copied by many manufacturers during the 1930s and 1940s because of its simplistic design and structural stability.

Upstate Door offers an elegant, historical design paired with structural stability for the person looking to match historical charm throughout a home!

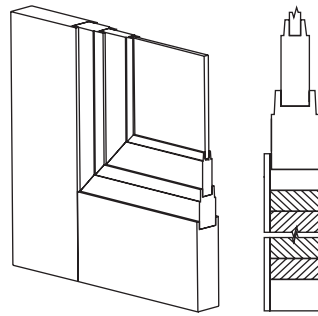

Gold Profile

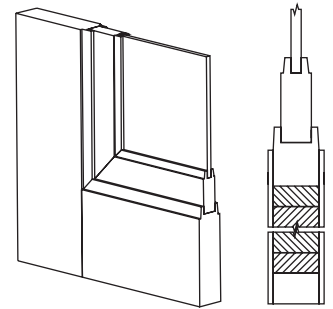

Silver Profile

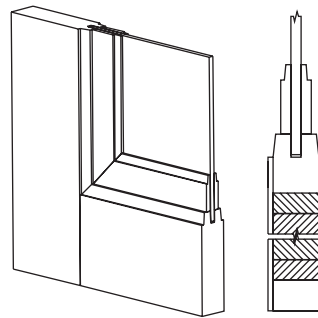

Bronze Profile

Mix and match different wood species within each layer to create charm and architectural elegance!

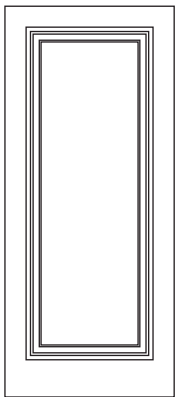
D D1005

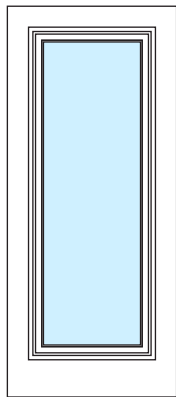

D D2005

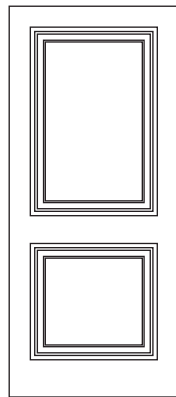

D D1045

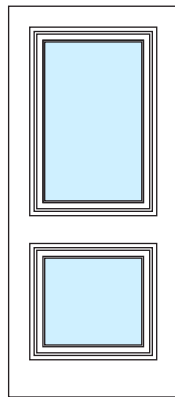

D D2165

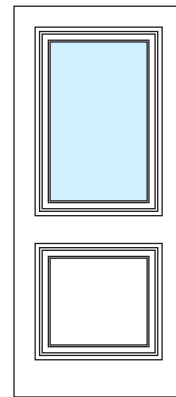

D D2055

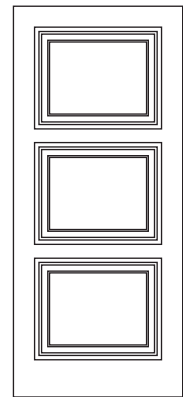

D D1135

For questions, please call our door experts at 800-570-8283



HISTORICAL REPLICATIONS

Upstate Door can easily accommodate unusual or unique sizes and shapes, which makes us a perfect partner for historical projects. We have the capability to match historical architectural details of many glass options or door layouts. We know that historical projects are challenging and we are willing to embrace that with professionalism and dedication to make sure that your historical door project is exactly what you are looking for.





COMMERCIAL DOORS

Upstate Door commercial doors are constructed to handle the demands of everyday use. Each door can be built according to your specifications. Talk to one of your door experts today to determine the correct hardware application!



For questions, please call our door experts at 800-570-8283

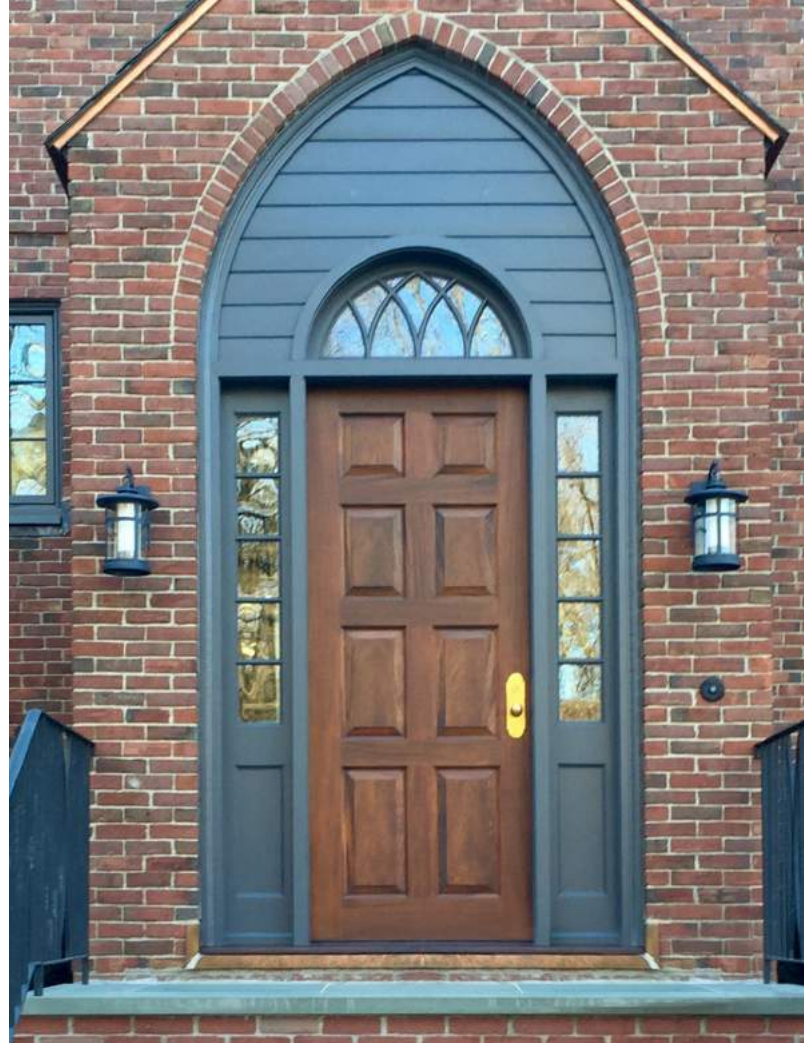





FINE FINISHING SOLUTIONS

Below are Upstate Door's variety of stain options featured on African Mahogany. We can also produce split finishes to match the outside of the home as well as the inside of the home. All of our finishes are a sheen-30 (satin) finish. We have the ability to match paint colors from many major manufacturers; just provide a color name or ID code and we can do the rest. Or, select just a clear top coat to highlight the natural beauty of the wood.



Stain Options

Shown on African Mahogany. Note that finishes will look different on other wood species.



Clear Coat
(No Stain)



Chappo



Ebony



Provincial



Red Mahogany



Walnut

Paint Options

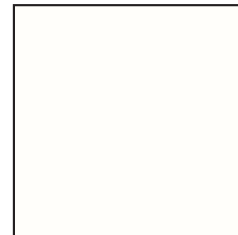

Classic White

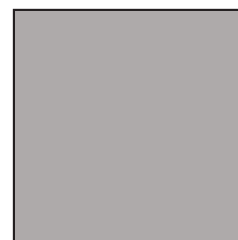

Base Coat:
Standard Gray

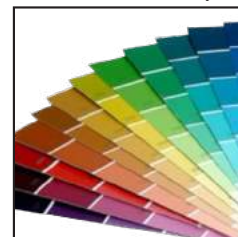

Match Many
Paint Colors

Eclectic

WHY SHOULD UPSTATE FINISH YOUR DOOR?



Helps activate the product warranty; see the guidelines on the next page



The top and bottom of the door are sealed to prevent water infiltration



Our finishing is done in a controlled environment to prevent dust or other imperfections getting in the finish



The finish is sprayed, not brushed, to offer a more consistent coating



Our finish expands and contracts with the natural movements of the wood without cracking or peeling



Finishing by the manufacturer ensures hard-to-reach areas are covered, including:

- Behind the glass (we paint or stain before the glass is installed)
- In and around all areas that were machined for hardware (behind the hinges, inside the bore)
- Behind the sticking and the spline of a screen
- Backside of the muntins and jambs
- All six sides of a door (front, back, top, bottom, and both side edges)

PAINT + STAIN PACKAGES

Why should you choose a factory finish package from Upstate Door? Industry standard warranties mandate that sealing all surfaces of your door is required shortly after your product is delivered. Having Upstate Door paint or stain your unit will give you peace of mind that this warranty stipulation is addressed immediately.

| Paint | Primed (primed only, no upcharge) | Primed Plus (primed, seal top and bottom) | Value (base coat) | Deluxe (top coat, standard paint colors) | Color Deluxe (top coat, custom paint colors) |
|---|---|--|--|---|--|
| White Latex Primer | ✓ | ✓ | - | - | - |
| Penetrating Wood Conditioner | - | ✓ Top & bottom only | ✓ | ✓ | ✓ |
| Sealing Coats (Three Coats) | - | ✓ Top & bottom only | ✓ | ✓ | ✓ |
| Top Coats (Three Coats) | - | - | - | ✓ | ✓ |
| Color Choices | White primer | White primer, green top & bottom | Gray | White or gray | Ability to color match most major paint manufacturer colors |
| Standard Warranty Eligible: 1 Year | ✓ Field finishing required within one week of delivery | ✓ Field finishing required within one week of delivery | ✓ Fulfills sealing stipulation to activate warranty | ✓ | ✓ *Some color restrictions apply |
| Upgrade Warranty Eligible: 2 Years | - | - | - | ✓ | ✓ *Some color restrictions apply |
| Benefits | Latex primed that is ready for field finishing | Helps seal vulnerable and hard to reach areas of the door in advance of a field finish | Durable base coat product that is ready for final top coats in field | Durable finished white or gray product that is ready to install | Durable and unique finished product that is ready to install |

| Stain | Sanded (sanded only, no upcharge) | Sanded Plus (sanded only, seal top and bottom with clear coat) | Deluxe (clear coat only) | Color Deluxe (stain and clear coat) |
|---|---|--|---|--|
| Penetrating Wood Conditioner | - | ✓ Top & bottom only | ✓ | ✓ |
| Sealing Coats (Three Coats) | - | ✓ Top & bottom only | ✓ | ✓ |
| Top Coats (Three Coats) | - | - | ✓ | ✓ |
| Color Choices | - | Clear coat top and bottom only | Clear coat only | Upstate Exclusive Colors See color chart, no custom colors |
| Standard Warranty Eligible: 1 Year | ✓ Field finishing required within one week of delivery | ✓ Field finishing required within one week of delivery | ✓ | ✓ |
| Upgrade Warranty Eligible: 2 Years | - | - | ✓ | ✓ |
| Benefits | Hand sanded and ready to apply field finishing | Helps seal vulnerable and hard to reach areas of the door in advance of a field finish | Durable and natural looking finished product that is ready to install | Durable and unique colored finished product that is ready to install |



WARRANTY

Upstate Door Inc. (Upstate) strives to produce superior quality doors that are engineered and designed specifically for each individual customer. Our products are intended to stand the test of time under normal conditions and use with proper handling, installation, finishing and on-going care.

Subject to the terms and conditions contained in paragraphs (I) through (VI) below, Upstate warrants all of our products “for (1) year” from the original date of delivery of the product against: (a) defects in workmanship, (b) defects in materials and (c) door warping. In the event of a covered warranty claim, Upstate will, at our discretion: (a) repair the affected product; (b) replace the affected product in its original state of purchase; or (c) refund the purchase price of the original product. Call or Email our Custom Door Experts to assist you.

I. LIMITATIONS AND EXCLUSIONS

- Upstate is not responsible for the removal, reinstallation or refinishing of any product other than the original state the product was sold in.
- It is the responsibility of the customer to keep accurate records of proper maintenance (according to the manufacturer of the finishing agent chosen), including, but not limited to, dated receipts and pictures.
- Upstate does not warranty any products that have not been installed in accordance with Upstate’s installation instructions.
- Damage caused by an event within the coverage of any insurance or casualty policy of the customer is excluded from warranty.
- Additional limitations and exclusions may apply in some custom applications.
- Defect in materials do not include checks or splits within a 1/32” x 3” tolerance.
- The natural characteristics of wood movement cannot be warranted, as slight shrinking and expansion may occur under certain conditions.
- Panel shrinkage of 1/8” or less. Note: Panels are designed to “float”. Changes in relative humidity may cause the wood panels to shrink, leaving an unfinished line along the panel edge.
- Splitting of panels which does not allow light to show through. Checks and small splits generally occur in hardwoods as a natural characteristic and are not considered defects unless the split allows light to show through.
- Only the products meeting the following stile & rail standards, on-flat dimensions are covered by this warranty. All other products are sold “as is.”

Dimensions are as follows:

| With Stave Core: | | Without Stave Core: | | Flush Doors: |
|------------------|---|---------------------|--|--|
| Interior | | Interior | | Exterior |
| Stiles | - 3.5” min. or - 4.5” min. with mortise | Stiles | - 4” min. or - No warranty if mortised | with mortise must have 4” edge banding and a plank construction to maintain warranty. |
| Top Rail | - 4” min. | Top Rail | - 4” min. | |
| Bottom Rail | - 6” min. | Bottom Rail | - 6” min. | |
| Exterior | | Exterior | | |
| Stiles | - 4” min. or - 5.5” min. with mortise | Stiles | - 4.5” min. or - No warranty if mortised | |
| Top Rail | - 4.5” min. | Top Rail | - 4.5” min. | |
| Bottom Rail | - 7” min. | Bottom Rail | - 7” min. | |

The following are excluded from warranty:

1. Doors wider than 42” and/or taller than 96”.
2. Interior doors less than 1 3/8” thick or exterior doors less than 1 3/4” thick.
3. Interior Pocket, full glass, or full panel doors without stave core stiles.
4. Doors containing solid wood panels wider than 14”. Upstate standards dictate that panels shall be made using Extra/MDF cores, wood edge-banding and veneered faces to reduce the amount of movement in the panels.

11. DOOR WARPING

Door warping is not considered a defect unless it exceeds one of the following guidelines:

- The warp is greater than 1/4” in doors that are 1 3/8”, 1 3/4” or 2 1/4” thick and up to 42” wide and 84” tall.
- The warp is greater than 3/8” in doors that are 1 3/4” to 2 1/4” thick and up to 42” wide and 84” to 96” tall.

The following are excluded from any warranty for door warping, bowing or twisting:

- A flush door that contains different wood species (split finish) of face veneers and/or planks on each side.
- The door has product/material applied to the face (i.e. mirrors, chalkboards, clothes hangers, etc.).
- The door was not completely finished/sealed with at least two (2) coats of paint, approved sealer, or varnish on all surfaces of the door, including hinge pockets and all machined surfaces, within one (1) week of delivery.
- Screen/storm doors are not warranted against warp, bow or twist.

If the claimed nonconformity is warp, Upstate Door may defer repairing or replacing the product for a period of up to twelve (12) months from the latter of the date of claim or the date of installation, as it is not uncommon for a temporary warp condition to occur as the door adjusts to local weather conditions. This deferral will not be counted against the warranty period.

Note – Door warping refers to the door itself, not to the appearance of the door hanging in relation to the jamb. Please see the “How to check for door warpage” worksheet and video to find out more.

III. VOIDING WARRANTY

This warranty shall terminate, and Upstate shall have no further obligation under this warranty if any of the following occur:

1. The door/product is not finished, painted, or sealed within one (1) week from delivery of the items.
2. All surfaces of the door/product are not finished, painted or sealed, including the top edge, bottom edge, front, back, door side edges and under/behind all hardware and weather seals (all 6 sides).
3. The customer accepts delivery of the product (formal acceptance is not required) and chooses to keep the product for more than 30 calendar days with reasonably obvious nonconformity and/or damage including any and all machining.
4. An Exterior door is not protected by an adequate overhang. An adequate overhang is determined by the distance from the bottom of the door/sill to the underside of the overhang (face height). To conform to this warranty, the overhang must project a minimum of one half of the face height dimension. See the Upstate Door installation instructions for more information.
5. The door is trimmed more than ¼” from either side, ¼” from the top, or 1” from the bottom.
6. The door has been finished with a distressed and/or sandblasted surface.
7. The door is finished with dark paint or stain or with inadequate, excessive, or neglected finish.
8. Variations or unsatisfactory results in gloss level, texture or appearance resulting from the field application of paint or other finishing material.
9. The door is exposed to the elements prior to being properly finished. (Factory priming is not a proper finish).
10. The distributor, contractor or end customer attempts to repair the product or alters the product in any way without written consent from an authorized Upstate representative.
11. An interior door is exposed to adverse or improper conditions, including but not limited to, installation directly in front of a heating or air conditioning duct, in a high humidity area such as a pool house or steam room, or in areas of extreme temperature variation, etc.
12. The door is damaged due to inadequate ventilation caused by the use of a storm door system. Excessive heat buildup will damage the door and is not covered under this warranty.
13. The door is damaged because of carelessness or negligence of the distributor, contractor or end customer.
14. Damage caused by attempts other than Upstate Door to repair the product.
15. Any modifications made to the product or misuse of the product that Upstate deems in its sole discretion to be the cause of the alleged product failure, will void this warranty.
16. The door was shipped outside of the continental United States.
17. Damage is caused by extreme environmental conditions or outside forces such as pressure washing damage.
18. Damage caused by any cause beyond the control of Upstate Door, including, but not limited to, normal wear and tear, weathering, customer misuse/abuse/neglect, or acts of nature.
19. The one (1) year warranty term has expired.

Note – Natural wood color variations and/or wood texture variations are not considered to be defects.

IV. WARRANTY CLAIMS

Immediately upon discovering any nonconformity and/or damage to the product, which is believed to be covered by warranty, you must:

1. Email or mail a detailed written description with photos of the nonconformity and/or damage to an authorized representative from the distributor you purchased the product from or directly to Upstate Door Inc.
2. All warranty claims must be submitted in writing within one (1) year of the original date of delivery.
3. Send accompanying photographs of the nonconformity and/or damage to the product. Please ensure the photos are not blurry and that they clearly identify the problem to avoid delay of the process.
4. Please see Upstate Door warranty claims link on the website for further details.

Note- Upstate Door is not responsible for any costs or charges relating to the replacement of the product, including transportation, shipping, removal, finishing, and installation.

V. EXPRESS LIMITATION

THIS LIMITED WARRANTY IS GIVEN IN LIEU OF ALL OTHER WARRANTIES, EXPRESSED OR IMPLIED, OF MERCHANTABILITY, FITNESS FOR USE, OR OTHERWISE. OUR LIABILITY IN THE EVENT OF BREACH OF WARRANTY OR CONTRACT, NEGLIGENCE, OR OTHERWISE IS STRICTLY LIMITED TO REFUND OF THE PURCHASE PRICE OR REPAIR OR REPLACEMENT OF THE DEFECTIVE PRODUCT. IN NO EVENT SHALL UPSTATE BE LIABLE FOR INCIDENTAL OR CONSEQUENTIAL DAMAGES AS DEFINED IN THE UNIFORM COMMERCIAL CODE. THIS WARRANTY SHALL BE VOID IF OUR PRODUCT IS USED OR MODIFIED IN A MANNER OTHER THAN IN ACCORDANCE WITH THE WRITTEN INSTRUCTIONS PROVIDED BY US.

VI. DISCLOSURE

Formal acceptance of this warranty is not required. By accepting delivery of the product, the customer is also accepting the terms and conditions of the Upstate Door Inc. limited warranty.

USE AND CARE GUIDE

General Door Handling & Care

1. Once your door(s)/unit(s) are delivered, be sure to carefully inspect the entire delivery for any visible defects (If you find an issue, please contact your Upstate Representative immediately).
2. DO NOT drag or slide one door across another door or along any other hard surface that could damage the door.
3. Doors should be stored flat or on a flat surface that is well ventilated. NEVER lean doors against a wall.
4. Cover door(s)/unit(s) to help keep them clean, ensuring that they have adequate airflow to all sides.
5. Door(s)/unit(s) should not be exposed to extreme heat, dryness, humidity and drastic changes in conditions.
6. DO NOT store door(s)/unit(s) in direct sunlight.

Preparation for Finishing

1. All door(s)/unit(s) should be given a few days between delivery and finishing to acclimate to the relative humidity of the location.
2. Door(s)/unit(s) must be sealed/finished within 24 hours of the product installation (this must fall within the 1 week limitation stated in Upstate Door Inc.'s standard warranty).
3. Before applying any type of finishing agent, lightly sand the product with 180 grit sandpaper (always sand in the same direction as the grain direction). Make sure to remove any and all scuffs, dings, fingerprints, scratches and unevenness of grain (that may have occurred during wood acclimation to the relative humidity of the location).
4. Before finishing the door(s)/unit(s), install the product and then remove the door from the unit (also remove all hardware) in order to properly finish the product as stated in Upstate Door Inc.'s standard warranty.
5. If the door(s)/unit(s) have glazing, be sure to apply a generous amount of top coat/finish to bridge between the wood and the glass. If you are painting the product, apply paint with a 1/16" lap onto the glass to provide adequate moisture protection.

Finishing the Product

1. Upstate recommends using a sanding sealer or a conditioner to be applied to the product(s) before finishing, helping in the ease of finishing the product(s).
2. Please use only high quality stain and/or paint to finish your door(s)/unit(s), and carefully follow all of the stain/paint manufacturer's instructions regarding application of the product.
3. If your door(s)/unit(s) are going to be placed in the structure with direct exposure to sunlight, Upstate recommends avoiding dark stains/paints. Excessive heat buildup will push moisture out of the wood, causing your door(s)/panel(s) to shrink and check/crack.
4. Pay careful attention to detail and make sure you seal all surfaces of the product(s) including: front & back faces, top/bottom/left/right edges, hinge pockets and all areas that have been machined for hardware (i.e. flush bolts, mortises, multi-points, etc.).
5. Upstate Door recommends applying a minimum of three (3) finish coats of high quality varnish/paint.
6. DO NOT use lacquer or polyurethane based sealers that do not have a UV inhibitor (applies to exterior applications only).

Long Term Care

1. Finishes that cover the entire door and are maintained properly will ensure a lifetime of beauty in your product(s).
2. Stains and clear finishes should be protected from sunlight and excessive weathering to prolong the finish of the product.
3. Inspect your door(s)/unit(s) on a regular basis (minimum annual inspection is recommended) for imperfections or wear to the finish.
4. During inspection, pay close attention to high wear areas such as around the handle set, the door edges and the bottom of the door where people are most likely to run their feet into the door inadvertently.
5. When refinishing is required, removing the door from the unit and removing all hardware from the door(s)/unit(s) is required.

Disclosure

1. Failure to follow and comply with these recommended guidelines may forfeit the validity of warranty claims.
2. All warranty claims will be reviewed on a case by case basis.
3. Upstate reserves the right to deny any warranty claim due to improper handling and/or care.
4. When an item is replaced or repaired under a warranty claim, Upstate is only responsible for replacing the item in the original state of "finished" condition that the product(s) were originally delivered in.

ARCHITECT ADVANTAGES

We recommend that our Architectural Representatives meet with you and your firm to offer trainings to provide fine door solutions. Ultimately, it is our goal to be a resource to you on your current or next project. We offer a team-based approach, offering time, advice, and solutions at your disposal, while creating and solidifying relationships.

We also offer levels of training based on knowledge and experience level of each architect. Architects are always welcome to join in on a plant tour with any dealer to learn more about our products and to see how we can match detail, alignments, and variety of options offered.

As an architect, you are required to continue your education and maintain your credentials. Upstate Door is proud to offer American Institute of Architects (AIA) accredited trainings.



BUILDER ADVANTAGES



As a custom builder, you want the doors of the home that you're building to be statement pieces. Upstate Door has the capability to create exactly what an architect specs, no matter how unique or detailed. Our doors are wrapped and shipped on our own fleet of trucks. You can feel comfortable knowing that we will create accurate shop drawings and you won't have to worry about the door cracking or failing because our quality and craftsmanship is second to none.

All doors are manufactured using the latest CNC technology. We perform machining for hinge pockets, hardware, downsizing and beveling all before the door is complete. If you are looking for quality, continuity, and accuracy, Upstate Door is the right company to deal with. No matter what kind of door you need, we're here to help you get the best solution for your job and your customer.

MOBILE SHOWROOM

Do you have an event coming up at your showroom or your office? Let us bring our products to you so your customers can touch, feel, and see the Upstate Door difference. Contact your Upstate Door Architectural Sales Representative today to set up an appointment.



For questions, please call our door experts at 800-570-8283



Warsaw, New York Facility



Upstate Door Team



Castile, New York Facility

DISTINCTIVE DOOR SOLUTIONS

Uniquely Crafted

Our custom solutions are individually created to your design & specifications for a unique door.

CLASSIC DOOR SOLUTIONS

Semi-Custom & Value

Our semi-custom solutions feature timeless styles, shorter lead times, and address project budget considerations.



UPSTATE DOOR[®]
FINE DOOR SOLUTIONS... ONE SOURCE

www.UpstateDoor.com | 800-570-8283

Contact us for more information!